

www.pfcstore.com - 763-425-7890 / 800-328-2350

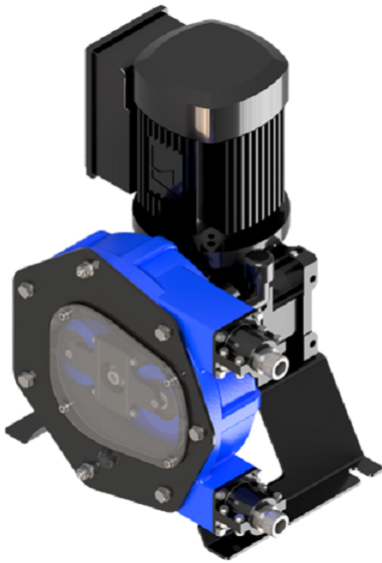

GRANZOW I21 INDUSTRIAL HOSE PUMP

CONTACT US FOR PRICING |

Model I21 is capable of pumping up to 4 gpm, Max 145 PSI and is perfect for dosing any type of media with up to $\pm 1\%$ accuracy. This is due to the excellent flow-rate control, a consistent flow rate in various pressure applications, and gentle pumping. Typical Lead time is 1 to 2 weeks



SKU: I21

Stock: Out of stock contact us for lead time

Categories: [Hose Pumps](#)

PRODUCT DESCRIPTION

[Specs](#)

[Brochure](#)

www.pfcstore.com - 763-425-7890 / 800-328-2350

HEAVY DUTY HOSE PUMPS WITH LARGE ROLLERS

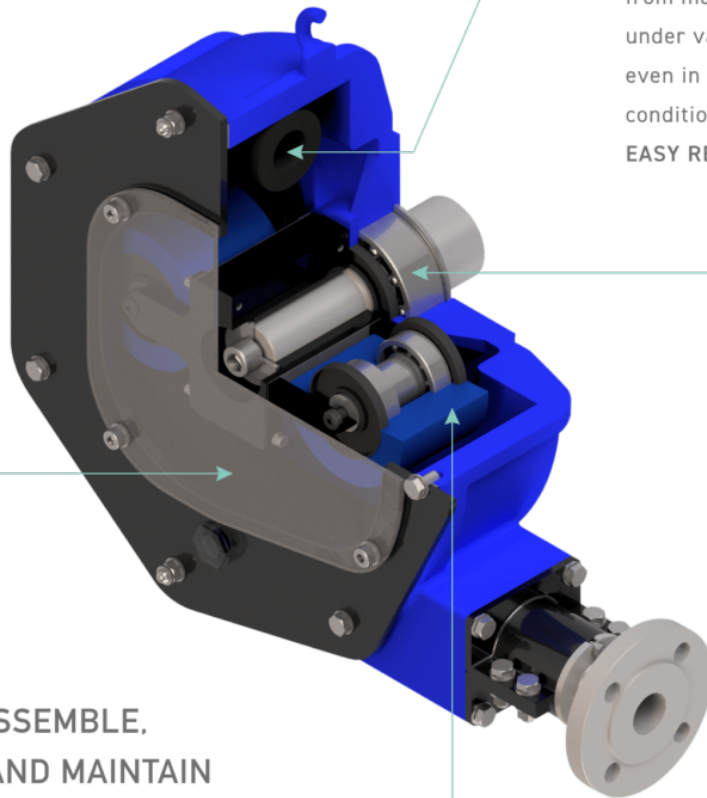

NEWEST PERISTALTIC HOSE TECHNOLOGY

High quality hose created with a unique manufacturing process: an extruded inner layer, high-density textile reinforcement and precision machined outer layer that ensures perfect compression and quick installation. Made from materials that are compatible with all types of media under various working conditions. Precise performance even in extreme temperatures or abrasive/corrosive conditions. **PROVIDES A LONGER HOSE LIFE WITH FAST, EASY REPLACEMENT.**

EXTREMELY HEAVY-DUTY DESIGN

Integrated oversized bearings to withstand axial loads, large metal rollers with oversized bearings, a secure and reliable connection system and robust construction materials create the ideal pump for continuous working conditions. **OFFERS UNRIVALED PUMP LIFE AND SUPERIOR PERFORMANCE IN THE HARSHTEST CONDITIONS.**

EASY TO ASSEMBLE, OPERATE AND MAINTAIN

Fast and simple assembly, commissioning and maintenance are possible thanks to an innovative design that allows for easy roller disassembly and quick hose replacement, resulting in less downtime. Only a small amount of lubricant is required producing minimal waste. **DECREASES COST AND DOWNTIME.**

XXL ROLLER TECHNOLOGY

Excellent hose compression with no friction results in unmatched efficiency. Large rollers create a longer hose life, low energy consumption, minimal starting torque and a very wide frequency range. **GENERATES ENERGY SAVINGS AND A HIGHER NUMBER OF HOSE WORKING HOURS.**

Features may be configured to customer's unique application needs.

ADDITIONAL INFORMATION

www.pfcestore.com - 763-425-7890 / 800-328-2350