



**GRUNDFOS BOOSTER
PUMP, 304SS W/NBR
SEAL, 3 PHASE 440-480V,
BM 160-1**

800 GPM @ 43 PSI | IP66 | 30HP |
Victaulic Connection 6" | 8" Pump |
Straight Pipe Connections | Check
lead time before ordering

The motor power ranges from 1HP
to 124HP . The motor must be
controlled by a VFD and protected
by Pt100 sensors. The VFD is sold
as a separate. We recommend a
Grundfos CUE VFD; however, VFDs
from alternative suppliers can be
used as well.



SKU: 20DS3601

Stock: Out of stock contact us for
lead time

Categories: [Grundfos BM Booster
Pumps](#)

Model Number BM 160-1

Part Number 20DS3601

GALLERY IMAGES

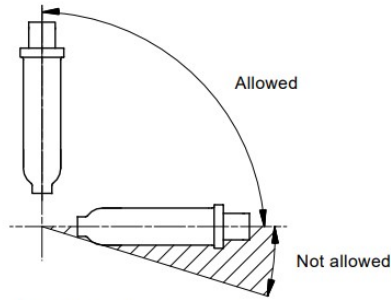

Fig. 1 Positional requirements

www.pfcstore.com - 763-425-7890 / 800-328-2350

PRODUCT DESCRIPTION

Grundfos BM Pumps and BMhp booster modules are designed for pressure boosting, liquid transfer and circulation in systems with a high static pressure.

The pumps are suitable for pumping thin, non-explosive liquids, not containing abrasive particles or fibres. The liquid must not attack the pump materials chemically and mechanically.

The sound pressure level of BM 4" and BM and BMhp 6" booster modules is lower than 70 dB(A).

The sound pressure level of BM and BMhp 8" booster modules is lower than 80 dB(A).

[Specs & Curve](#)

[Install Manual](#)

ADDITIONAL INFORMATION

Weight	569 lbs
Dimensions	100 × 16 × 16 in
Best Efficiency Point	<u>800 GPM @ 100 FTH</u>
Wetted Material	<u>304SS-NBR</u>