



GRUNDFOS BOOSTER PUMP, 304SS W/NBR SEAL, 3 PHASE 440-480V, BM 5A-11

25 GPM @ 95 PSI | IP66 | 2HP |
Victaulic Connection 1.65" | 4"
Pump | Check lead time before
ordering

The motor power ranges from 1HP to 124HP . The motor must be controlled by a VFD and protected by Pt100 sensors. The VFD is sold as a separate. We recommend a Grundfos CUE VFD; however, VFDs from alternative suppliers can be used as well.



SKU: 5783611

Stock: Out of stock contact us for lead time

Categories: [Grundfos BM Booster Pumps](#)

Model Number BM 5A-11

Part Number 5783611-5793611

GALLERY IMAGES

BM 4"

Straight version



Bent version

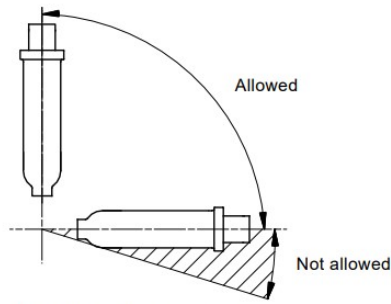

Fig. 1 Positional requirements

www.pfcstore.com - 763-425-7890 / 800-328-2350

PRODUCT DESCRIPTION

Grundfos BM Pumps and BMhp booster modules are designed for pressure boosting, liquid transfer and circulation in systems with a high static pressure.

The pumps are suitable for pumping thin, non-explosive liquids, not containing abrasive particles or fibres. The liquid must not attack the pump materials chemically and mechanically.

The sound pressure level of BM 4" and BM and BMhp 6" booster modules is lower than 70 dB(A).

The sound pressure level of BM and BMhp 8" booster modules is lower than 80 dB(A).

[Specs & Curve](#)

[Install Manual](#)

ADDITIONAL INFORMATION

Weight	138 lbs
Dimensions	55 × 11 × 11 in
Best Efficiency Point	<u>25 GPM @ 219 FTH</u>
Wetted Material	<u>304SS-NBR</u>

25 GPM @ 95 PSI | IP66 | 2HP | Victaulic Connection 1.65" | 4" Pump | Check lead time before ordering

www.pfcstore.com - 763-425-7890 / 800-328-2350

The motor power ranges from 1HP to 124HP . The motor must be controlled by a VFD and protected by Pt100 sensors. The VFD is sold as a separate. We recommend a Grundfos CUE VFD; however, VFDs from alternative suppliers can be used as well.