



## GRUNDFOS BOOSTER PUMP, 304SS W/NBR SEAL, 3 PHASE 440-480V, BM 60-15

300 GPM @ 270 PSI | IP66 | 60HP | Victaulic Connection 4" | 8" Pump | Straight Pipe Connections | Check lead time before ordering

The motor power ranges from 1HP to 124HP . The motor must be controlled by a VFD and protected by Pt100 sensors. The VFD is sold as a separate. We recommend a Grundfos CUE VFD; however, VFDs from alternative suppliers can be used as well.



---

**SKU:** 14DS3615

**Stock:** Out of stock contact us for lead time

**Categories:** [Grundfos BM Booster Pumps](#)

**Model Number** BM 60-15

**Part Number** 14DS3615

## GALLERY IMAGES

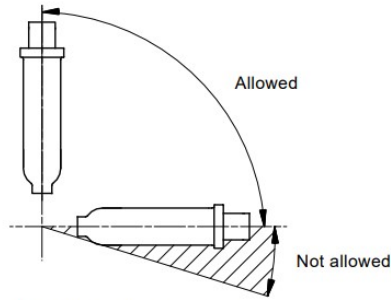

Fig. 1 Positional requirements

[www.pfcstore.com](http://www.pfcstore.com) - 763-425-7890 / 800-328-2350

## PRODUCT DESCRIPTION

Grundfos BM Pumps and BMhp booster modules are designed for pressure boosting, liquid transfer and circulation in systems with a high static pressure.

The pumps are suitable for pumping thin, non-explosive liquids, not containing abrasive particles or fibres. The liquid must not attack the pump materials chemically and mechanically.

The sound pressure level of BM 4" and BM and BMhp 6" booster modules is lower than 70 dB(A).

The sound pressure level of BM and BMhp 8" booster modules is lower than 80 dB(A).

[Specs & Curve](#)

[Install Manual](#)

## ADDITIONAL INFORMATION

<b>Weight</b>	969 lbs
<b>Dimensions</b>	142 × 16 × 16 in
<b>Best Efficiency Point</b>	<a href="#"><u>300 GPM @ 624 FTH</u></a>
<b>Wetted Material</b>	<a href="#"><u>304SS-NBR</u></a>