



GRUNDFOS BOOSTER PUMP, 304SS W/NBR SEAL, 3 PHASE 440-480V, BM 77-10

400 GPM @ 270 PSI | IP66 | 75HP | Victaulic Connection 5" | 8" Pump | Straight Pipe Connections | Check lead time before ordering

The motor power ranges from 1HP to 124HP . The motor must be controlled by a VFD and protected by Pt100 sensors. The VFD is sold as a separate. We recommend a Grundfos CUE VFD; however, VFDs from alternative suppliers can be used as well.



SKU: 16DS3610

Stock: Out of stock contact us for lead time

Categories: [Grundfos BM Booster Pumps](#)

Model Number BM 77-10

Part Number 16DS3610

GALLERY IMAGES

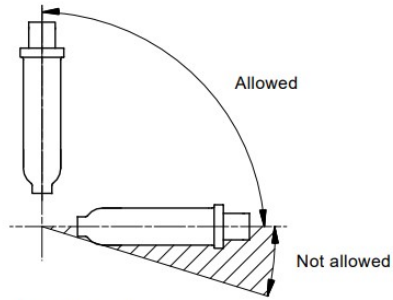

Fig. 1 Positional requirements

www.pfcstore.com - 763-425-7890 / 800-328-2350

PRODUCT DESCRIPTION

Grundfos BM Pumps and BMhp booster modules are designed for pressure boosting, liquid transfer and circulation in systems with a high static pressure.

The pumps are suitable for pumping thin, non-explosive liquids, not containing abrasive particles or fibres. The liquid must not attack the pump materials chemically and mechanically.

The sound pressure level of BM 4" and BM and BMhp 6" booster modules is lower than 70 dB(A).

The sound pressure level of BM and BMhp 8" booster modules is lower than 80 dB(A).

[Specs & Curve](#)

[Install Manual](#)

ADDITIONAL INFORMATION

Weight	1040 lbs
Dimensions	156 × 16 × 16 in
Best Efficiency Point	<u>400 GPM @ 625 FTH</u>
Wetted Material	<u>304SS-NBR</u>