

www.pfcstore.com - 763-425-7890 / 800-328-2350



**GRUNDFOS BOOSTER  
PUMP, 304SS W/NBR  
SEAL, 3 PHASE 440-480V,  
BM 77-7**

400 GPM @ 180 PSI | IP66 | 60HP |  
Victaulic Connection 5" | 8" Pump |  
Straight Pipe Connections | Check  
lead time before ordering

The motor power ranges from 1HP  
to 124HP . The motor must be  
controlled by a VFD and protected  
by Pt100 sensors. The VFD is sold  
as a separate. We recommend a  
Grundfos CUE VFD; however, VFDs  
from alternative suppliers can be  
used as well.



---

**SKU:** 16DS3607

**Stock:** Out of stock contact us for  
lead time

**Categories:** [Grundfos BM Booster  
Pumps](#)

**Model Number** BM 77-7  
**Part Number** 16DS3607

## GALLERY IMAGES

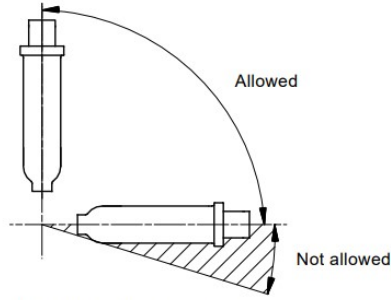

Fig. 1 Positional requirements

[www.pfcstore.com](http://www.pfcstore.com) - 763-425-7890 / 800-328-2350

## PRODUCT DESCRIPTION

Grundfos BM Pumps and BMhp booster modules are designed for pressure boosting, liquid transfer and circulation in systems with a high static pressure.

The pumps are suitable for pumping thin, non-explosive liquids, not containing abrasive particles or fibres. The liquid must not attack the pump materials chemically and mechanically.

The sound pressure level of BM 4" and BM and BMhp 6" booster modules is lower than 70 dB(A).

The sound pressure level of BM and BMhp 8" booster modules is lower than 80 dB(A).

[Specs & Curve](#)

[Install Manual](#)

## ADDITIONAL INFORMATION

<b>Weight</b>	921 lbs
<b>Dimensions</b>	132 × 16 × 16 in
<b>Best Efficiency Point</b>	<a href="#"><u>400 GPM @ 415 FTH</u></a>
<b>Wetted Material</b>	<a href="#"><u>304SS-NBR</u></a>