



GRUNDFOS BOOSTER PUMP, 304SS W/NBR SEAL, 3 PHASE 440-480V, BM 95-4

500 GPM @ 100 PSI | IP66 | 35HP |
Victaulic Connection 5" | 8" Pump |
Straight Pipe Connections | Check
lead time before ordering

The motor power ranges from 1HP
to 124HP . The motor must be
controlled by a VFD and protected
by Pt100 sensors. The VFD is sold
as a separate. We recommend a
Grundfos CUE VFD; however, VFDs
from alternative suppliers can be
used as well.



SKU: 19DS3604

Stock: Out of stock contact us for
lead time

Categories: [Grundfos BM Booster
Pumps](#)

Model Number BM 95-4

Part Number 19DS3604

GALLERY IMAGES

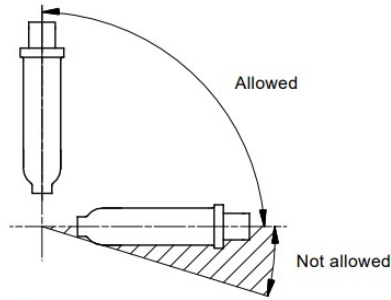

Fig. 1 Positional requirements

www.pfcstore.com - 763-425-7890 / 800-328-2350

PRODUCT DESCRIPTION

Grundfos BM Pumps and BMhp booster modules are designed for pressure boosting, liquid transfer and circulation in systems with a high static pressure.

The pumps are suitable for pumping thin, non-explosive liquids, not containing abrasive particles or fibres. The liquid must not attack the pump materials chemically and mechanically.

The sound pressure level of BM 4" and BM and BMhp 6" booster modules is lower than 70 dB(A).

The sound pressure level of BM and BMhp 8" booster modules is lower than 80 dB(A).

[Specs & Curve](#)

[Install Manual](#)

ADDITIONAL INFORMATION

Weight	585 lbs
Dimensions	102 × 16 × 16 in
Best Efficiency Point	<u>500 GPM @ 231 FTH</u>
Wetted Material	<u>304SS-NBR</u>

500 GPM @ 100 PSI | IP66 | 35HP | Victaulic Connection 5" | 8" Pump | Straight Pipe Connections | Check lead time before ordering

www.pfcstore.com - 763-425-7890 / 800-328-2350

The motor power ranges from 1HP to 124HP . The motor must be controlled by a VFD and protected by Pt100 sensors. The VFD is sold as a separate. We recommend a Grundfos CUE VFD; however, VFDs from alternative suppliers can be used as well.