

www.pfcstore.com - 763-425-7890 / 800-328-2350



GRUNDFOS BOOSTER PUMP, 904LSS W/NBR SEAL, 3 PHASE 440-480V, BMHP 125-2

600 GPM @ 85 PSI | IP66 | 40HP |
Victaulic Connection 6.6147" | 8"
Pump | Straight Pipe Connections |
Check lead time before ordering

The motor power ranges from 1HP
to 124HP . The motor must be
controlled by a VFD and protected
by Pt100 sensors. The VFD is sold
as a separate. We recommend a
Grundfos CUE VFD; however, VFDs
from alternative suppliers can be
used as well.



SKU: 96293311

Stock: Out of stock contact us for
lead time

Categories: [Grundfos BM Booster
Pumps](#)

Model Number BMhp 125-2
Part Number 96293311

GALLERY IMAGES

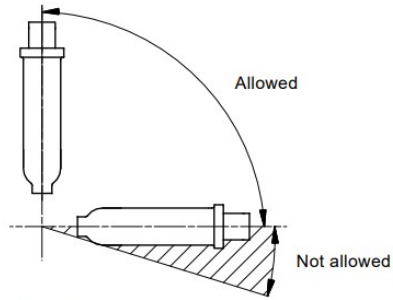

Fig. 1 Positional requirements

www.pfcstore.com - 763-425-7890 / 800-328-2350

PRODUCT DESCRIPTION

Grundfos BM Pumps and BMhp booster modules are designed for pressure boosting, liquid transfer and circulation in systems with a high static pressure.

The pumps are suitable for pumping thin, non-explosive liquids, not containing abrasive particles or fibres. The liquid must not attack the pump materials chemically and mechanically.

The sound pressure level of BM 4" and BM and BMhp 6" booster modules is lower than 70 dB(A).

The sound pressure level of BM and BMhp 8" booster modules is lower than 80 dB(A).

[Specs & Curve](#)

[Install Manual](#)

ADDITIONAL INFORMATION

Weight	604 lbs
Dimensions	101 × 16 × 16 in
Best Efficiency Point	<u>600 GPM @ 205 FTH</u>
Wetted Material	<u>904LSS-NBR</u>

600 GPM @ 85 PSI | IP66 | 40HP | Victaulic Connection 6.6147" | 8" Pump | Straight Pipe Connections | Check lead time before ordering

www.pfcstore.com - 763-425-7890 / 800-328-2350

The motor power ranges from 1HP to 124HP . The motor must be controlled by a VFD and protected by Pt100 sensors. The VFD is sold as a separate. We recommend a Grundfos CUE VFD; however, VFDs from alternative suppliers can be used as well.