



**GRUNDFOS BOOSTER
PUMP, 904LSS W/NBR
SEAL, 3 PHASE 440-480V,
BMHP 18-6**

90 GPM @ 90 PSI | IP66 | 7.5HP |
Victaulic Connection 3.50" | 6"
Pump | Straight Pipe Connections |
Check lead time before ordering

Direct replacement of BMhp 17

The motor power ranges from 1HP
to 124HP . The motor must be
controlled by a VFD and protected
by Pt100 sensors. The VFD is sold
as a separate. We recommend a
Grundfos CUE VFD; however, VFDs
from alternative suppliers can be
used as well.



SKU: 93078180

Stock: Out of stock contact us for
lead time

Categories: [Grundfos BM Booster
Pumps](#)

Model Number BMhp 18-6

GALLERY IMAGES

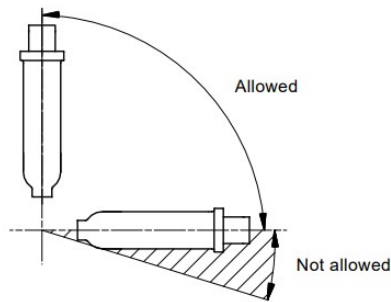

Fig. 1 Positional requirements

www.pfcstore.com - 763-425-7890 / 800-328-2350

PRODUCT DESCRIPTION

Grundfos BM Pumps and BMhp booster modules are designed for pressure boosting, liquid transfer and circulation in systems with a high static pressure.

The pumps are suitable for pumping thin, non-explosive liquids, not containing abrasive particles or fibres. The liquid must not attack the pump materials chemically and mechanically.

The sound pressure level of BM 4" and BM and BMhp 6" booster modules is lower than 70 dB(A).

The sound pressure level of BM and BMhp 8" booster modules is lower than 80 dB(A).

[Specs & Curve](#)

[Install Manual](#)

ADDITIONAL INFORMATION

Weight	277 lbs
Dimensions	92 × 16 × 16 in
Best Efficiency Point	<u>90 GPM @ 210 FTH</u>
Wetted Material	<u>904LSS-NBR</u>