

Position	Count	Description
	1	<p>CRN 1S-3 A-FGJ-A-V-HQQV</p>  <p>Product No.: 96081877 Vertical, non-self-priming, multistage, in-line, centrifugal pump for installation in pipe systems and mounting on a foundation.</p> <p>The pump has the following characteristics:</p> <ul style="list-style-type: none"> - Impellers, intermediate chambers and outer sleeve are made of - Pump head cover and base are made of - The shaft seal has assembly length according to EN 12756. - Power transmission is via cast iron split coupling. <p>flanges/couplings.</p> <p>The motor is a 1-phase AC motor.</p> <p>Controls: Frequency converter: NONE</p> <p>Liquid: Pumped liquid: Water Liquid temperature range: -4 .. 194 °F Liquid temperature during operation: 68 °F Density: 62.29 lb/ft³</p> <p>Technical: Rated flow: 4.84 US gpm Rated head: 59.39 ft Pump orientation: Vertical Shaft seal arrangement: Single Code for shaft seal: HQQV Approvals on nameplate: CURUS Curve tolerance: ISO9906:2012 3B</p> <p>Materials: Base: Stainless steel EN 1.4408 AISI 316 Impeller: Stainless steel EN 1.4401 AISI 316 Bearing: SIC</p> <p>Installation: Maximum ambient temperature: 104 °F Maximum operating pressure: 363 psi Max pressure at stated temperature: 363 psi / 194 °F 363 psi / -4 °F</p> <p>Type of connection: DIN / ANSI / JIS Size of inlet connection: DN 25/32 Size of suction port: 1 1/4 inch Size of outlet connection: DN 25/32 Size of outlet port: 1 1/4 inch Pressure rating for pipe connection: PN 25 Flange rating inlet: 300 lb</p>

Position	Count	Description
		<p>Flange size for motor: 56C</p> <p>Electrical data:</p> <p>Motor standard: NEMA</p> <p>Motor type: Baldor</p> <p>Rated power - P2: 0.33 HP</p> <p>Power (P2) required by pump: 0.33 HP</p> <p>Main frequency: 60 Hz</p> <p>Rated voltage: 1 x 115/230 V</p> <p>Service factor: 1.35</p> <p>Rated current: 6.00/3.00 A</p> <p>Rated speed: 3450 rpm</p> <p>Number of poles: 2</p> <p>Insulation class (IEC 85): B</p> <p>Others:</p> <p>Net weight: 52.9 lb</p> <p>Gross weight: 63.9 lb</p> <p>Shipping volume: 4.94 ft³</p> <p>Country of origin: US</p> <p>Custom tariff no.: 8413.70.2040</p>

96081877 CRN 1S-3 A-FGJ-A-V-HQQV 60 Hz

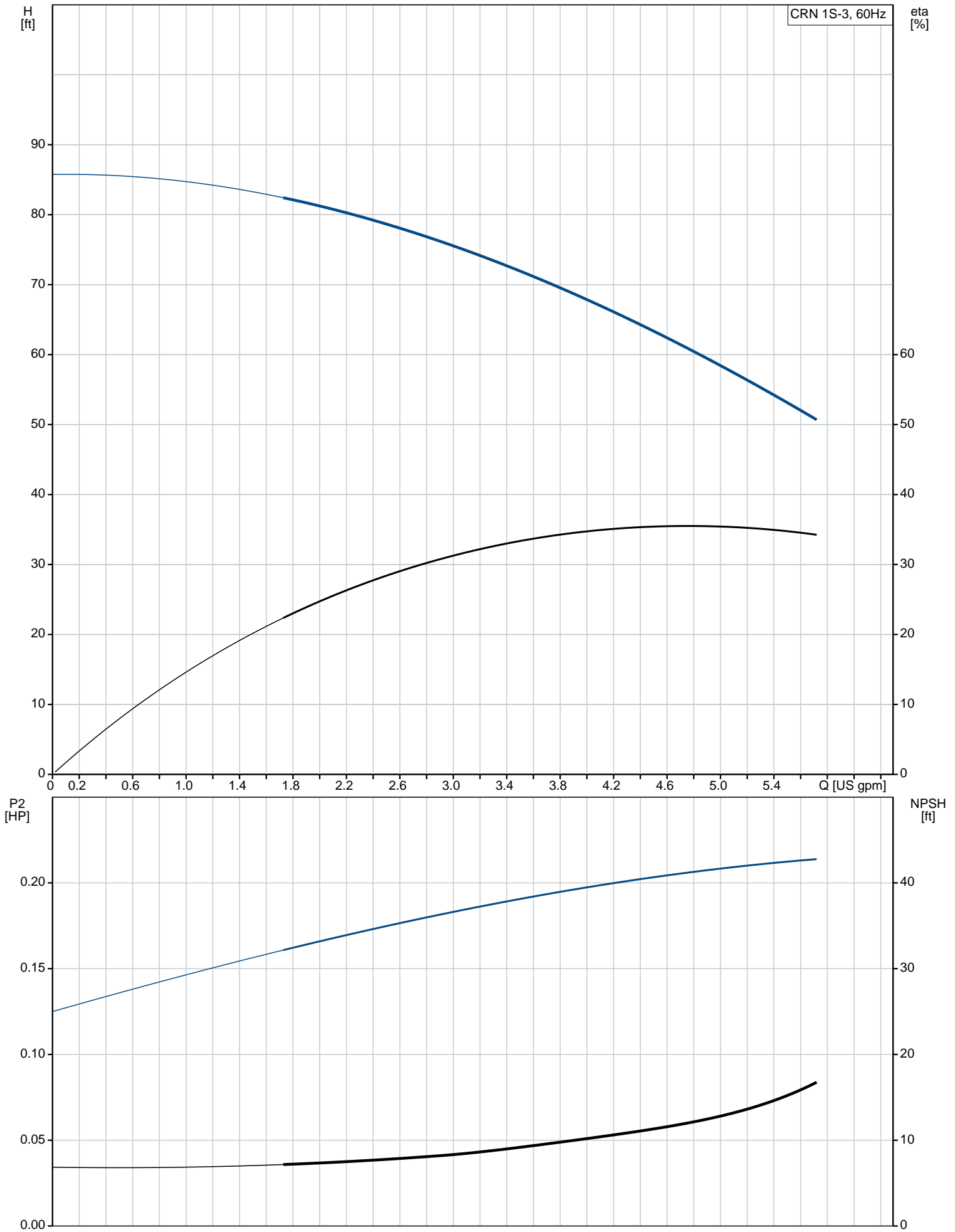

Description	Value
General information:	
Product name:	CRN 1S-3 A-FGJ-A-V-HQQV
Product No.:	96081877
EAN:	5700395163315
Technical:	
Rated flow:	4.84 US gpm
Rated head:	59.39 ft
Stages:	3
Impellers:	3
Number of reduced-diameter impellers:	0
Low NPSH:	N
Pump orientation:	Vertical
Shaft seal arrangement:	Single
Code for shaft seal:	HQQV
Approvals on nameplate:	CURUS
Curve tolerance:	ISO9906:2012 3B
Pump version:	A
Model:	A
Cooling:	TEFC
Materials:	
Base:	Stainless steel EN 1.4408 AISI 316
Impeller:	Stainless steel EN 1.4401 AISI 316
Material code:	A
Code for rubber:	V
Bearing:	SIC
Installation:	
Maximum ambient temperature:	104 °F
Maximum operating pressure:	363 psi
Max pressure at stated temperature:	363 psi / 194 °F 363 psi / -4 °F
Type of connection:	DIN / ANSI / JIS
Size of inlet connection:	DN 25/32
Size of suction port:	1 1/4 inch
Size of outlet connection:	DN 25/32
Size of outlet port:	1 1/4 inch
Pressure rating for pipe connection:	PN 25
Flange rating inlet:	300 lb
Flange size for motor:	56C
Connect code:	FGJ
Liquid:	
Pumped liquid:	Water
Liquid temperature range:	-4 .. 194 °F
Liquid temperature during operation:	68 °F
Density:	62.29 lb/ft³
Electrical data:	
Motor standard:	NEMA
Motor type:	Baldor
Rated power - P2:	0.33 HP
Power (P2) required by pump:	0.33 HP
Main frequency:	60 Hz
Rated voltage:	1 x 115/230 V
Service factor:	1.35
Rated current:	6.00/3.00 A
Load current:	6.8/3.4 A
Rated speed:	3450 rpm
Number of poles:	2
Insulation class (IEC 85):	B
Motor Number:	85680001
Controls:	
Frequency converter:	NONE
Others:	
Net weight:	52.9 lb

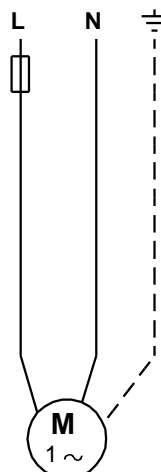
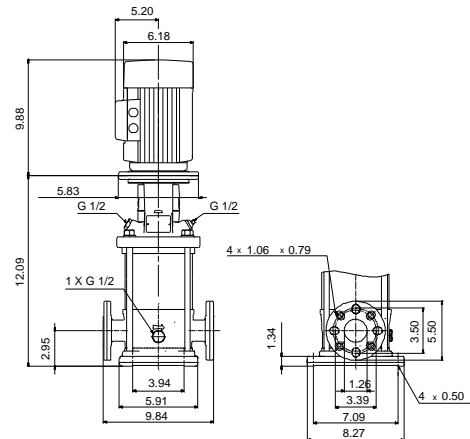
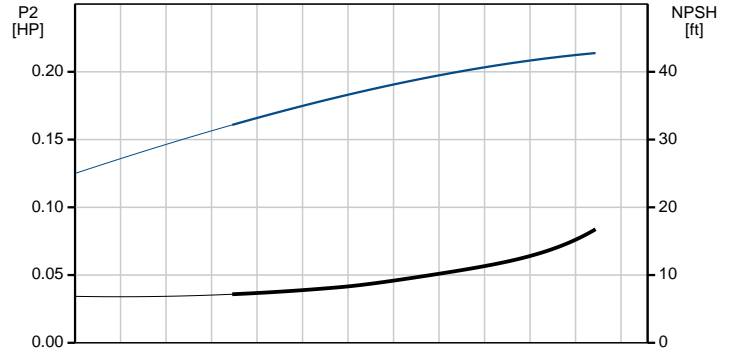
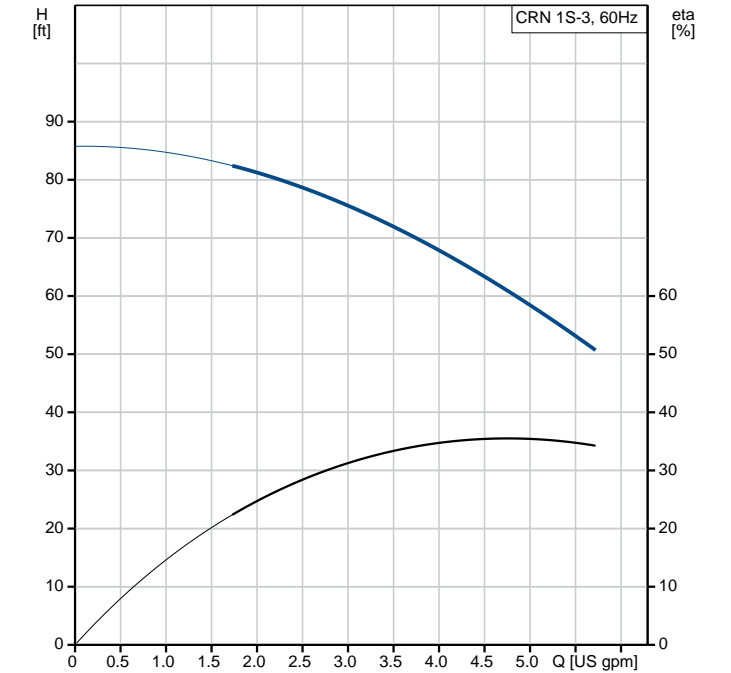



Company name:
Created by:
Phone:

Date: 10/19/2018

Description	Value
Gross weight:	63.9 lb
Shipping volume:	4.94 ft ³
Country of origin:	US
Custom tariff no.:	8413.70.2040

96081877 CRN 1S-3 A-FGJ-A-V-HQQV 60 Hz

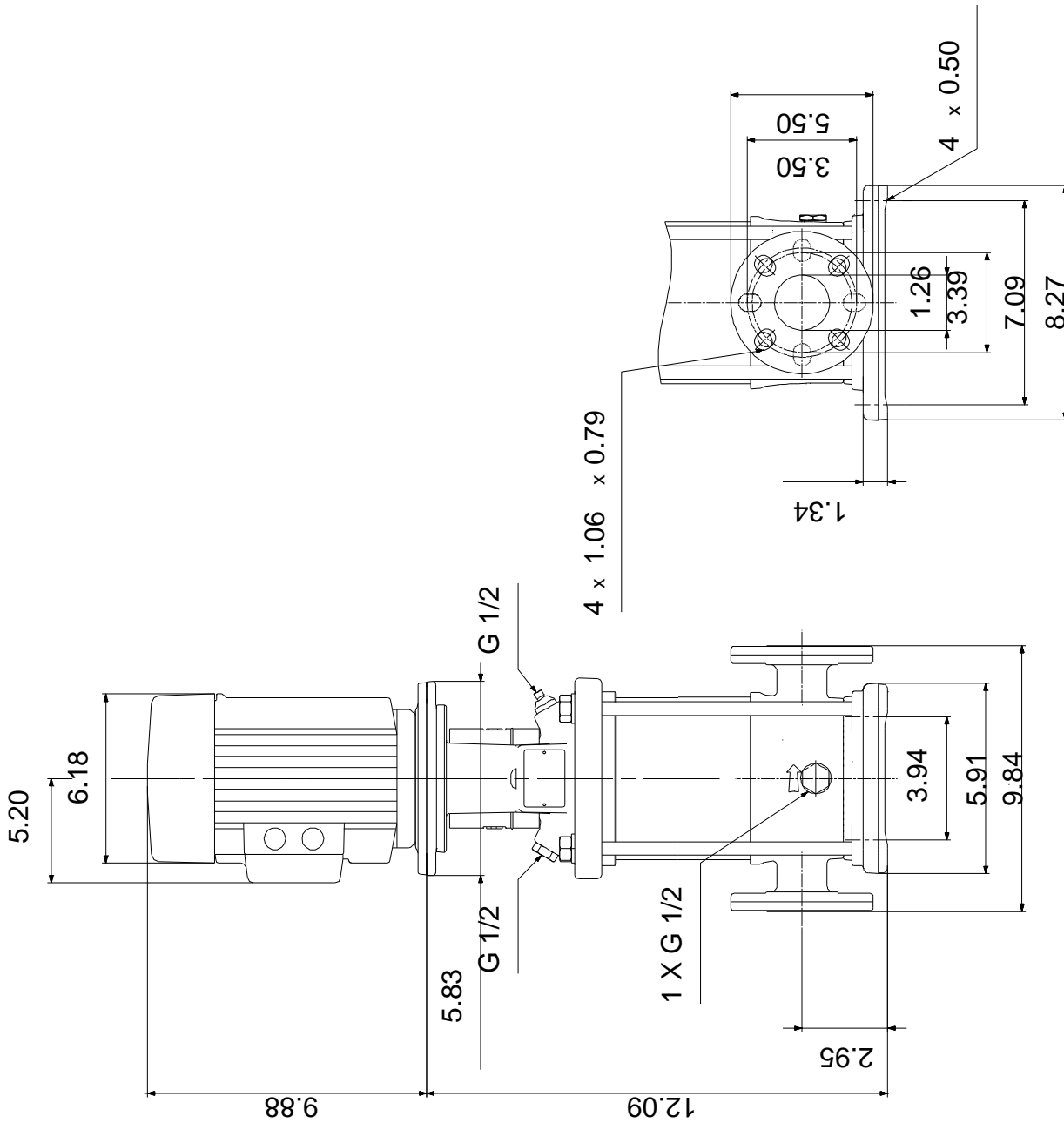

96081877 CRN 1S-3 A-FGJ-A-V-HQQV 60 Hz

