

PROJECT: _____	UNIT TAG: _____	QUANTITY: _____
REPRESENTATIVE: _____	TYPE OF SERVICE: _____	DATE: _____
ENGINEER: _____	SUBMITTED BY: _____	DATE: _____
CONTRACTOR: _____	APPROVED BY: _____	DATE: _____
	ORDER NO.: _____	DATE: _____



CR 45-7 K-G-A-E-HQQE

Vertical, multistage centrifugal pump with suction and discharge ports on the same level. The pump head and base are in cast iron. All other wetted parts are in stainless steel (EN 1.4301) (AISI 304)

Product photo could vary from the actual product

Conditions of Service	Pump Data	Motor Data
Flow: _____	Max pressure at stated temperature: 435 psi / 250 °F	Rated power - P2: 60 HP
Head: _____	Liquid temperature range: -22 .. 248 °F	Rated voltage: 230/460 V
Efficiency: _____	Maximum ambient temperature: 122 °F	Main frequency: 60 Hz
Liquid: Water	Approvals: CURUS	Enclosure class: 54 Dust/Splashing
Temperature: 68 °F	Shaft seal: HQQE	Insulation class: F
NPSH required: ft	Product number: 97787963	Motor protection: NONE
Viscosity: _____		Motor type: Baldor
Specific Gravity: 1.000		

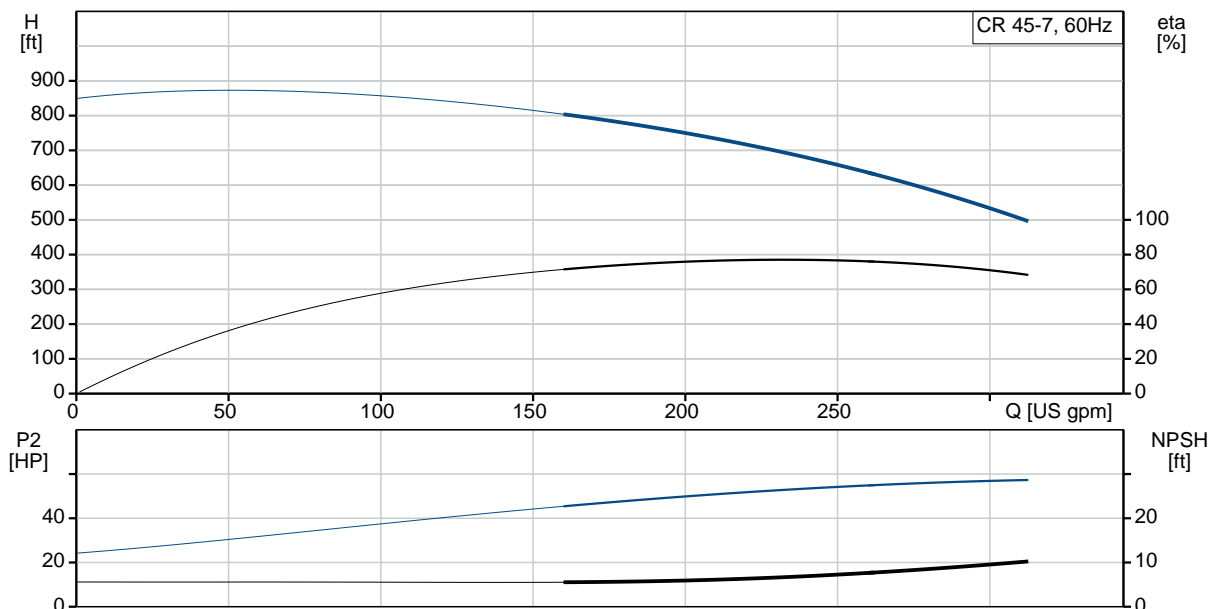

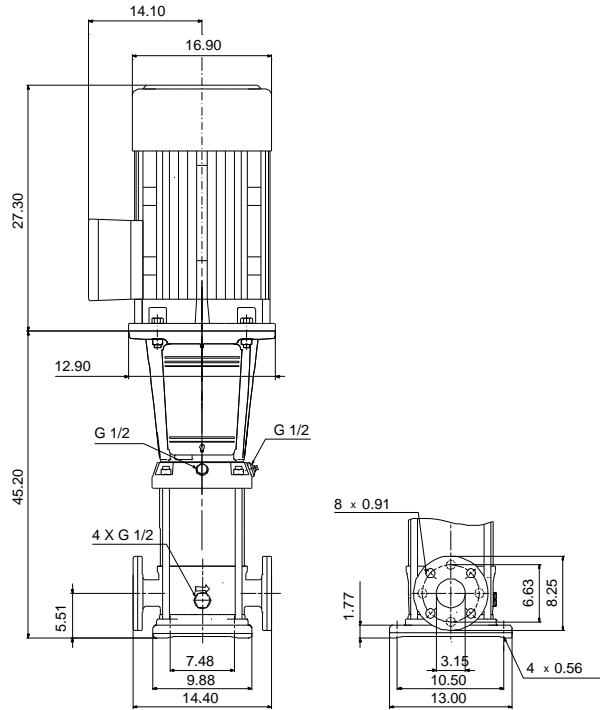

Materials:

Base: Cast iron
 EN 1563 EN-GJS-500-7
 ASTM A536 80-55-06

Impeller: Stainless steel
 AISI 304
 EN 1.4301

Material code: A
 Code for rubber: E



Company name:
Created by:
Phone:

Date: 6/20/2019

97787963 CR 45-7 K-G-A-E-HQQE 60 Hz

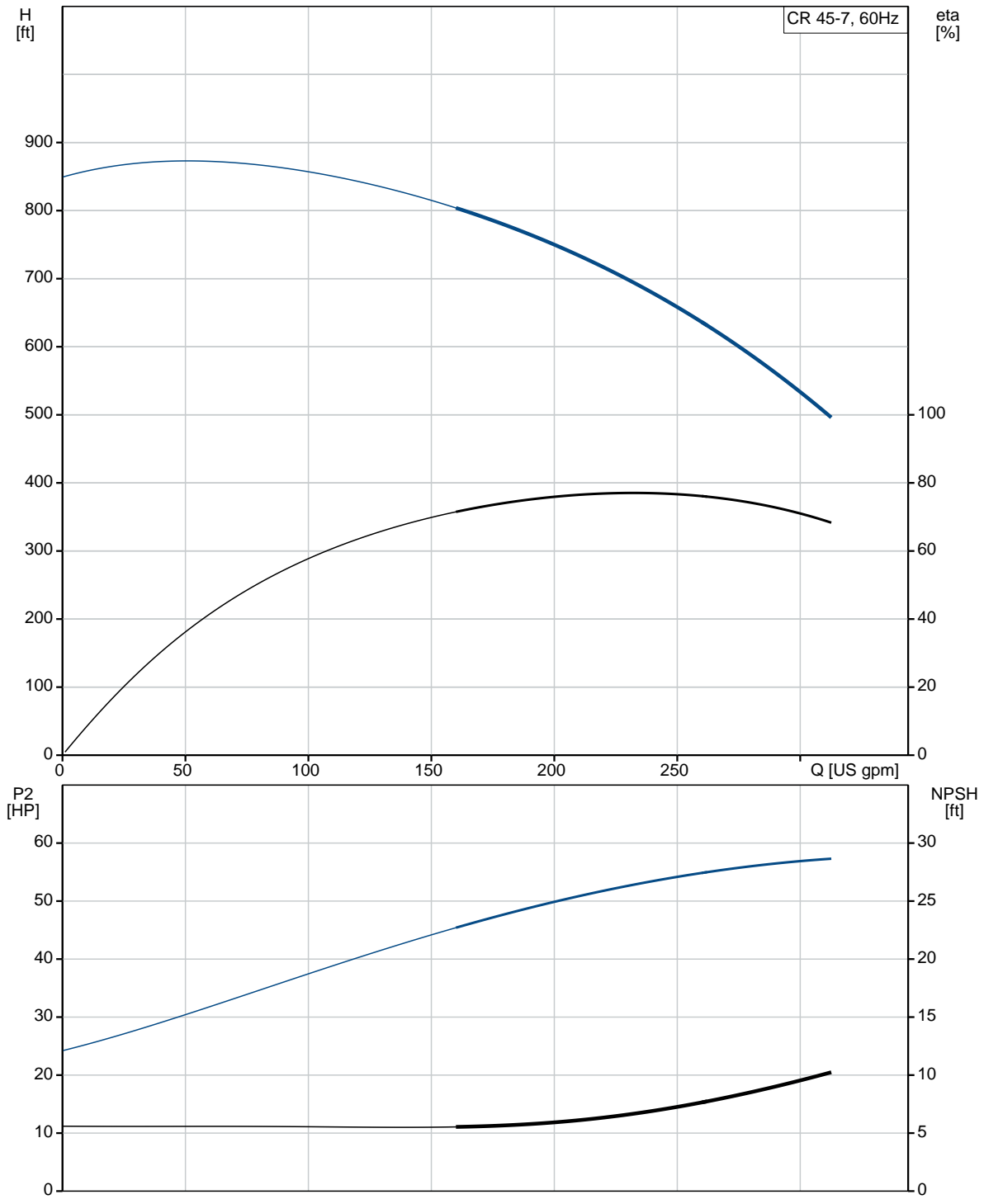



Company name:
Created by:
Phone:

Date: 6/20/2019

Description	Value
General information:	
Product name:	CR 45-7 K-G-A-E-HQQE
Product No.:	97787963
EAN:	5710624739563
Technical:	
Rated pump speed:	3550 rpm
Rated flow:	238 US gpm
Rated head:	686.7 ft
Head max:	846.2 ft
Stages:	7
Impellers:	7
Number of reduced-diameter impellers:	0
Low NPSH:	Y
Pump orientation:	Vertical
Shaft seal arrangement:	Single
Code for shaft seal:	HQQE
Approvals on nameplate:	CURUS
Curve tolerance:	ISO9906:2012 3B
Pump version:	K
Model:	B
Cooling:	TEFC
Materials:	
Base:	Cast iron EN 1563 EN-GJS-500-7
	ASTM A536 80-55-06
Impeller:	Stainless steel EN 1.4301 AISI 304
Material code:	A
Code for rubber:	E
Bearing:	SIC
Support bearing:	Graflon
Installation:	
Maximum ambient temperature:	122 °F
Maximum operating pressure:	435.11 psi
Max pressure at stated temperature:	435 psi / 250 °F
	435 psi / -22 °F
Type of connection:	ANSI
Size of suction port:	3 inch
Size of outlet port:	3 inch
Pressure rating for pipe connection:	PN 40
Flange rating inlet:	300 lb
Flange size for motor:	364TC
Connect code:	G
Liquid:	

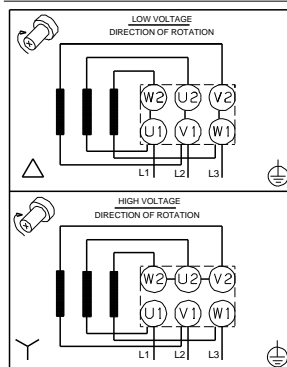
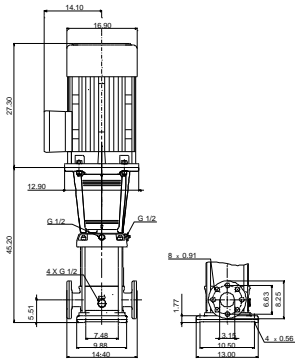
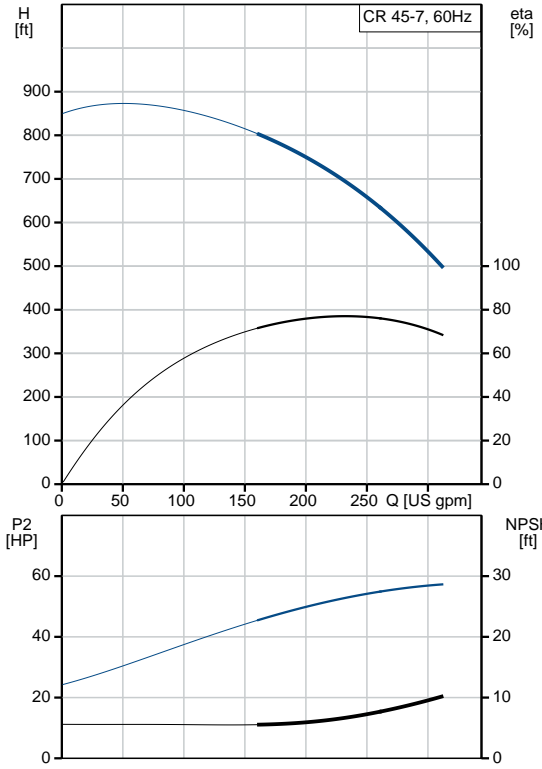



Company name:

Created by:

Phone:

Date:

6/20/2019

Description	Value
Pumped liquid:	Water
Liquid temperature range:	-22 .. 248 °F
Selected liquid temperature:	68 °F
Density:	62.29 lb/ft ³
Electrical data:	
Motor standard:	NEMA
Motor type:	Baldor
IE Efficiency class:	NEMA Premium / IE3 60Hz
Rated power - P2:	60 HP
Power (P2) required by pump:	60 HP
Main frequency:	60 Hz
Rated voltage:	3 x 230/460 V
Service factor:	1.15
Rated current:	132/66 A
Load current:	150/75 A
Cos phi - power factor:	0.87
Rated speed:	3550 rpm
IE efficiency:	IE3 93,6%
Number of poles:	2
Enclosure class (IEC 34-5):	54 Dust/Splashing
Insulation class (IEC 85):	F
Motor protection:	NONE
Motor Number:	84Z03818
Controls:	
Frequency converter:	NONE
Others:	
Net weight:	827 lb
Gross weight:	845 lb
Shipping volume:	39.9 ft ³
Country of origin:	US
Custom tariff no.:	8413.70.2040



Company name:
Created by:
Phone:

Date: 6/20/2019

97787963 CR 45-7 K-G-A-E-HQQE 60 Hz

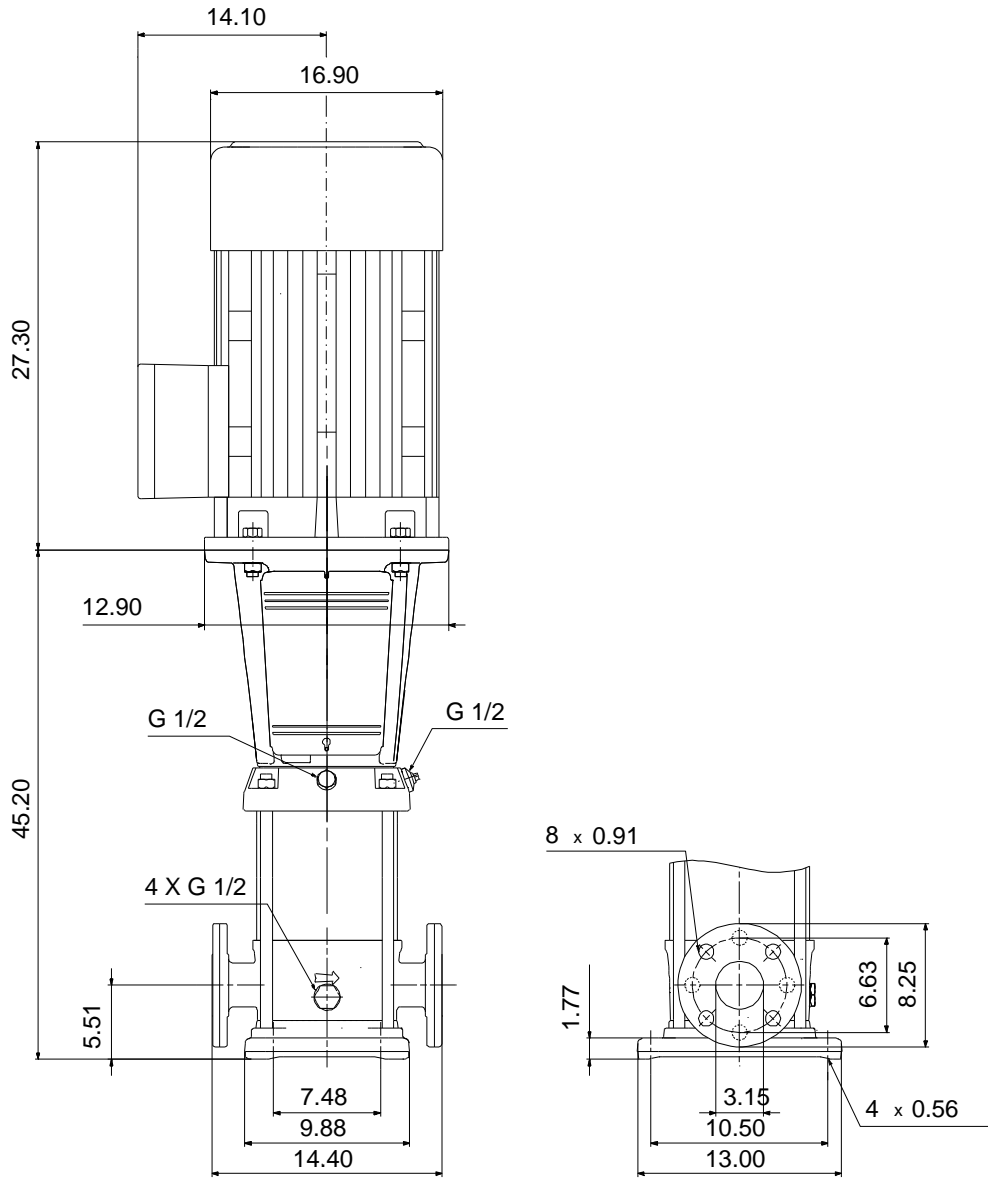

Note! All units are in [in] unless otherwise stated.
Disclaimer: This simplified dimensional drawing does not show all details.

97787963 CR 45-7 K-G-A-E-HQQE 60 Hz

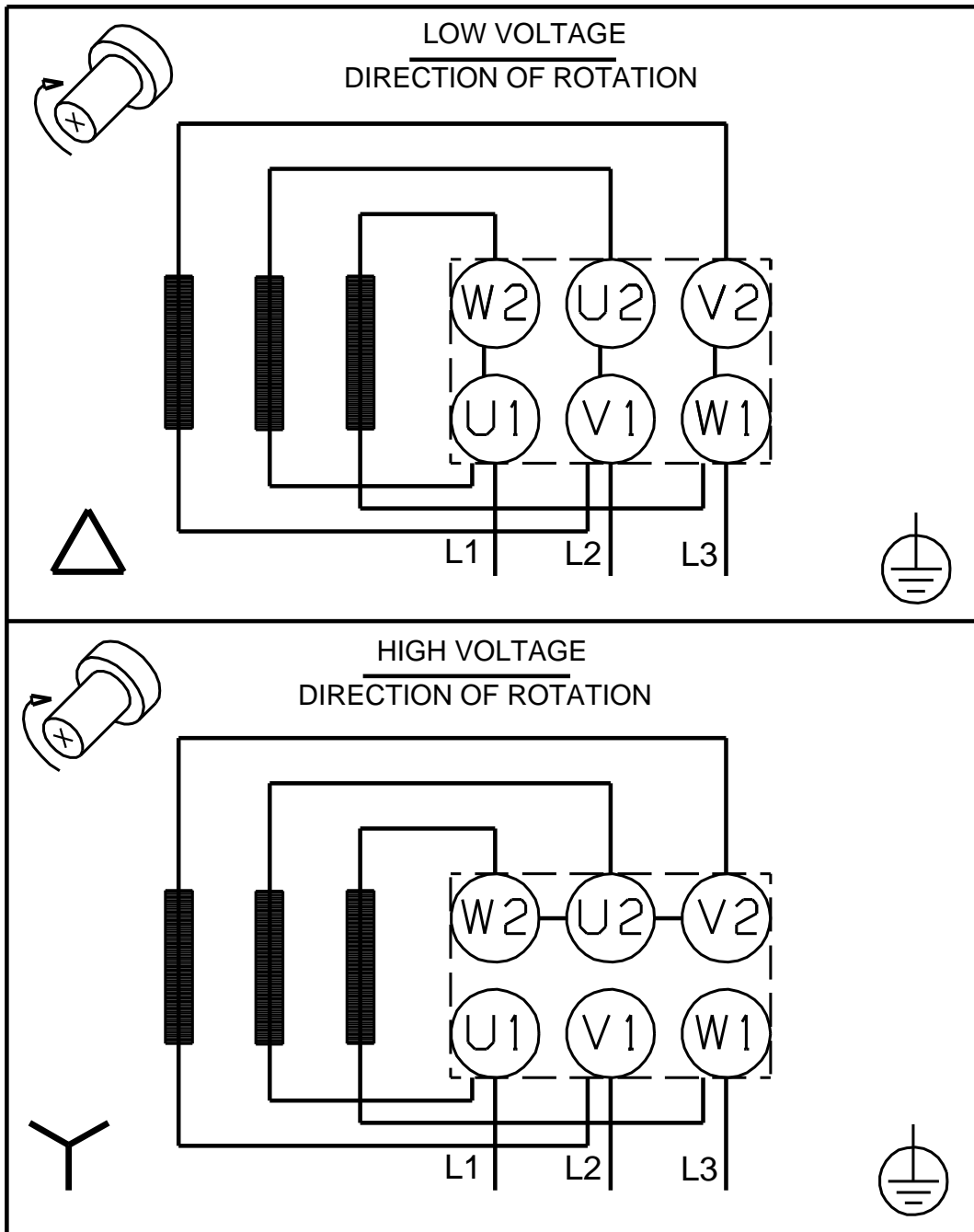

All units are [in] unless otherwise presented.