

Count	Description
1	<p data-bbox="225 342 536 365">CRN 1S-23 A-P-A-E-HQQE</p>  <p data-bbox="225 663 491 685">Product No.: 96081622</p> <p data-bbox="225 692 748 777">Vertical, non-self-priming, multistage, in-line, centrifugal pump for installation in pipe systems and mounting on a foundation.</p> <p data-bbox="225 810 703 837">The pump has the following characteristics:</p> <ul data-bbox="264 842 782 1016" style="list-style-type: none"> - Impellers, intermediate chambers and outer sleeve are made of - Pump head cover and base are made of - The shaft seal has assembly length according to EN 12756. - Power transmission is via cast iron split coupling. <p data-bbox="225 1048 424 1075">flanges/couplings.</p> <p data-bbox="225 1108 600 1135">The motor is a 1-phase AC motor.</p> <p data-bbox="225 1169 336 1196">Controls:</p> <p data-bbox="225 1200 660 1227">Frequency converter: NONE</p> <p data-bbox="225 1261 312 1288">Liquid:</p> <p data-bbox="225 1292 660 1319">Pumped liquid: Water</p> <p data-bbox="225 1323 715 1350">Liquid temperature range: -4 .. 248 °F</p> <p data-bbox="225 1355 651 1382">Selected liquid temperature: 68 °F</p> <p data-bbox="225 1386 708 1413">Density: 62.29 lb/ft³</p> <p data-bbox="225 1447 347 1473">Technical:</p> <p data-bbox="225 1478 695 1505">Rated pump speed: 3450 rpm</p> <p data-bbox="225 1509 735 1536">Rated flow: 4.84 US gpm</p> <p data-bbox="225 1541 676 1568">Rated head: 416.4 ft</p> <p data-bbox="225 1572 676 1599">Pump orientation: Vertical</p> <p data-bbox="225 1603 660 1630">Shaft seal arrangement: Single</p> <p data-bbox="225 1635 660 1662">Code for shaft seal: HQQE</p> <p data-bbox="225 1666 759 1693">Approvals on nameplate: CURUS,NSF61</p> <p data-bbox="225 1697 788 1724">Curve tolerance: ISO9906:2012 3B</p> <p data-bbox="225 1758 341 1785">Materials:</p> <p data-bbox="225 1789 751 1852">Base: Stainless steel EN 1.4408 AISI 316</p> <p data-bbox="225 1863 751 1926">Impeller: Stainless steel EN 1.4401 AISI 316</p> <p data-bbox="225 1937 632 1964">Bearing: SIC</p> <p data-bbox="225 1998 363 2024">Installation:</p> <p data-bbox="225 2029 663 2056">Maximum ambient temperature: 104 °F</p> <p data-bbox="225 2060 703 2087">Maximum operating pressure: 362.59 psi</p>



Company name:

Created by:

Phone:

Date:

8/6/2019

Count	Description
	Max pressure at stated temperature: 363 psi / 250 °F 363 psi / -4 °F
	Type of connection: PJE
	Size of inlet connection: DN 32
	Size of suction port: 1 1/4 inch
	Size of outlet connection: DN 32
	Size of outlet port: 1 1/4 inch
	Pressure rating for pipe connection: PN 50
	Flange size for motor: 56C
	Electrical data:
	Motor standard: NEMA
	Motor type: Baldor
	Rated power - P2: 1.5 HP
	Power (P2) required by pump: 1.5 HP
	Main frequency: 60 Hz
	Rated voltage: 1 x 115/208-230 V
	Service factor: 1.30
	Rated current: 17/9,50-8,60 A
	Rated speed: 3450 rpm
	Number of poles: 2
	Insulation class (IEC 85): B
	Motor Number: 84Z04007
	Others:
	Net weight: 85.4 lb
	Gross weight: 99.9 lb
	Shipping volume: 8.26 ft³
	Country of origin: US
	Custom tariff no.: 8413.70.2040



Company name:

Created by:

Phone:

Date:

8/6/2019

96081622 CRN 1S-23 A-P-A-E-HQQE 60 Hz

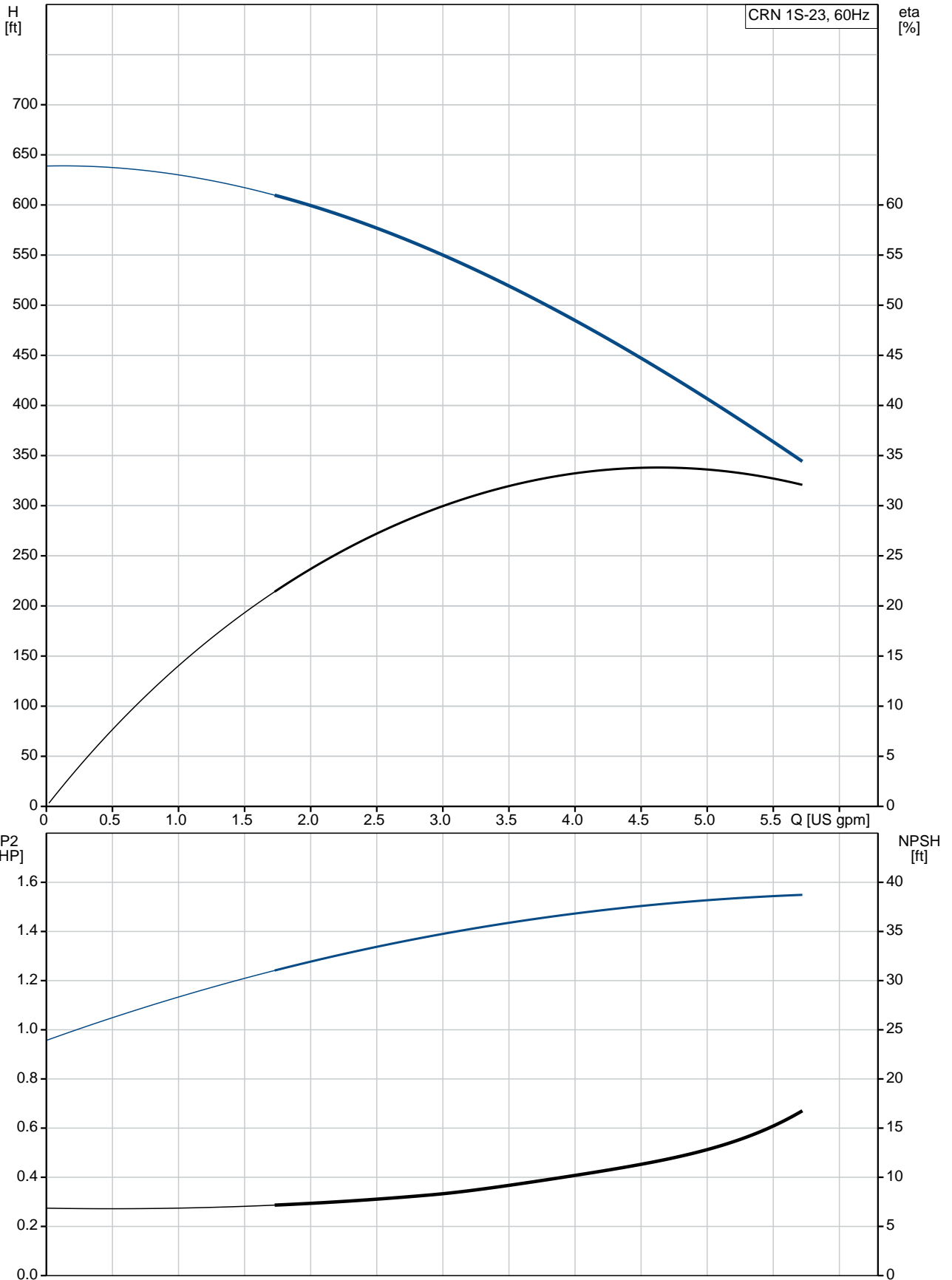

Description	Value
General information:	
Product name:	CRN 1S-23 A-P-A-E-HQQE
Product No.:	96081622
EAN:	5700395160666
Technical:	
Rated pump speed:	3450 rpm
Rated flow:	4.84 US gpm
Rated head:	416.4 ft
Head max:	631.6 ft
Stages:	23
Impellers:	23
Number of reduced-diameter impellers:	0
Low NPSH:	N
Pump orientation:	Vertical
Shaft seal arrangement:	Single
Code for shaft seal:	HQQE
Approvals on nameplate:	CURUS,NSF61
Curve tolerance:	ISO9906:2012 3B
Pump version:	A
Model:	A
Cooling:	TEFC
Materials:	
Base:	Stainless steel EN 1.4408 AISI 316
Impeller:	Stainless steel EN 1.4401 AISI 316
Material code:	A
Code for rubber:	E
Bearing:	SIC
Installation:	
Maximum ambient temperature:	104 °F
Maximum operating pressure:	362.59 psi
Max pressure at stated temperature:	363 psi / 250 °F 363 psi / -4 °F
Type of connection:	PJE
Size of inlet connection:	DN 32
Size of suction port:	1 1/4 inch
Size of outlet connection:	DN 32
Size of outlet port:	1 1/4 inch
Pressure rating for pipe connection:	PN 50
Flange size for motor:	56C
Connect code:	P
Liquid:	
Pumped liquid:	Water
Liquid temperature range:	-4 .. 248 °F
Selected liquid temperature:	68 °F
Density:	62.29 lb/ft³
Electrical data:	
Motor standard:	NEMA
Motor type:	Baldor
Rated power - P2:	1.5 HP
Power (P2) required by pump:	1.5 HP
Main frequency:	60 Hz
Rated voltage:	1 x 115/208-230 V
Service factor:	1.30

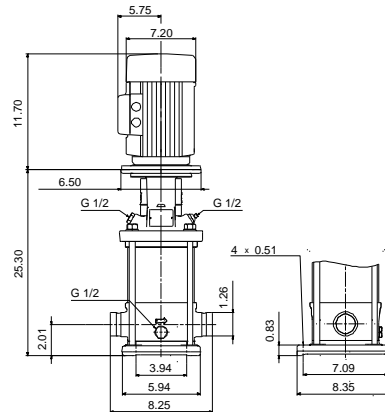
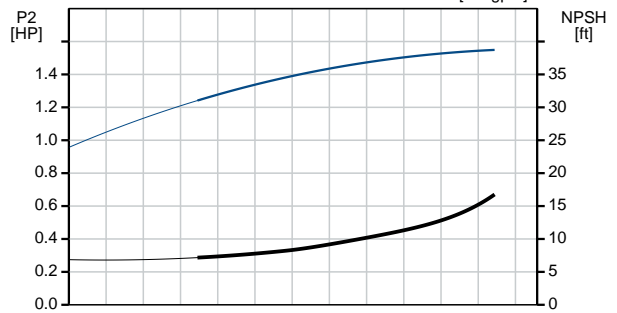
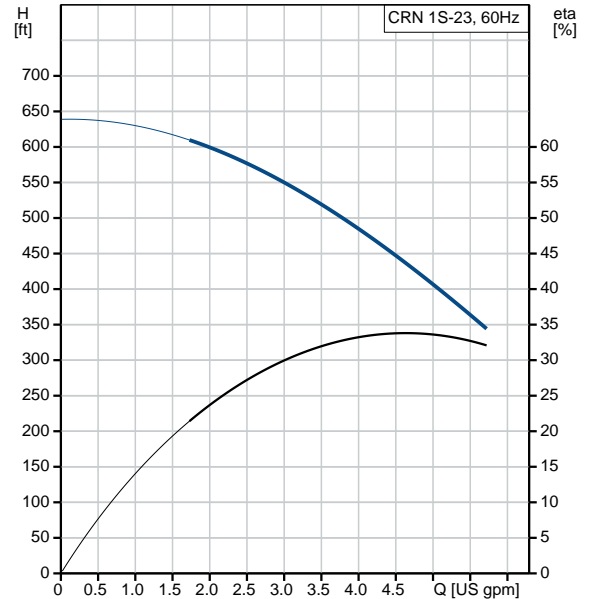



Company name:

Created by:

Phone:

Date:

8/6/2019

Description	Value
Rated current:	17/9,50-8,60 A
Load current:	20,4/11,3-10,2 A
Rated speed:	3450 rpm
Number of poles:	2
Insulation class (IEC 85):	B
Motor protection:	NONE
Motor Number:	84Z04007
Controls:	
Frequency converter:	NONE
Others:	
Net weight:	85.4 lb
Gross weight:	99.9 lb
Shipping volume:	8.26 ft ³
Country of origin:	US
Custom tariff no.:	8413.70.2040

96081622 CRN 1S-23 A-P-A-E-HQQE 60 Hz

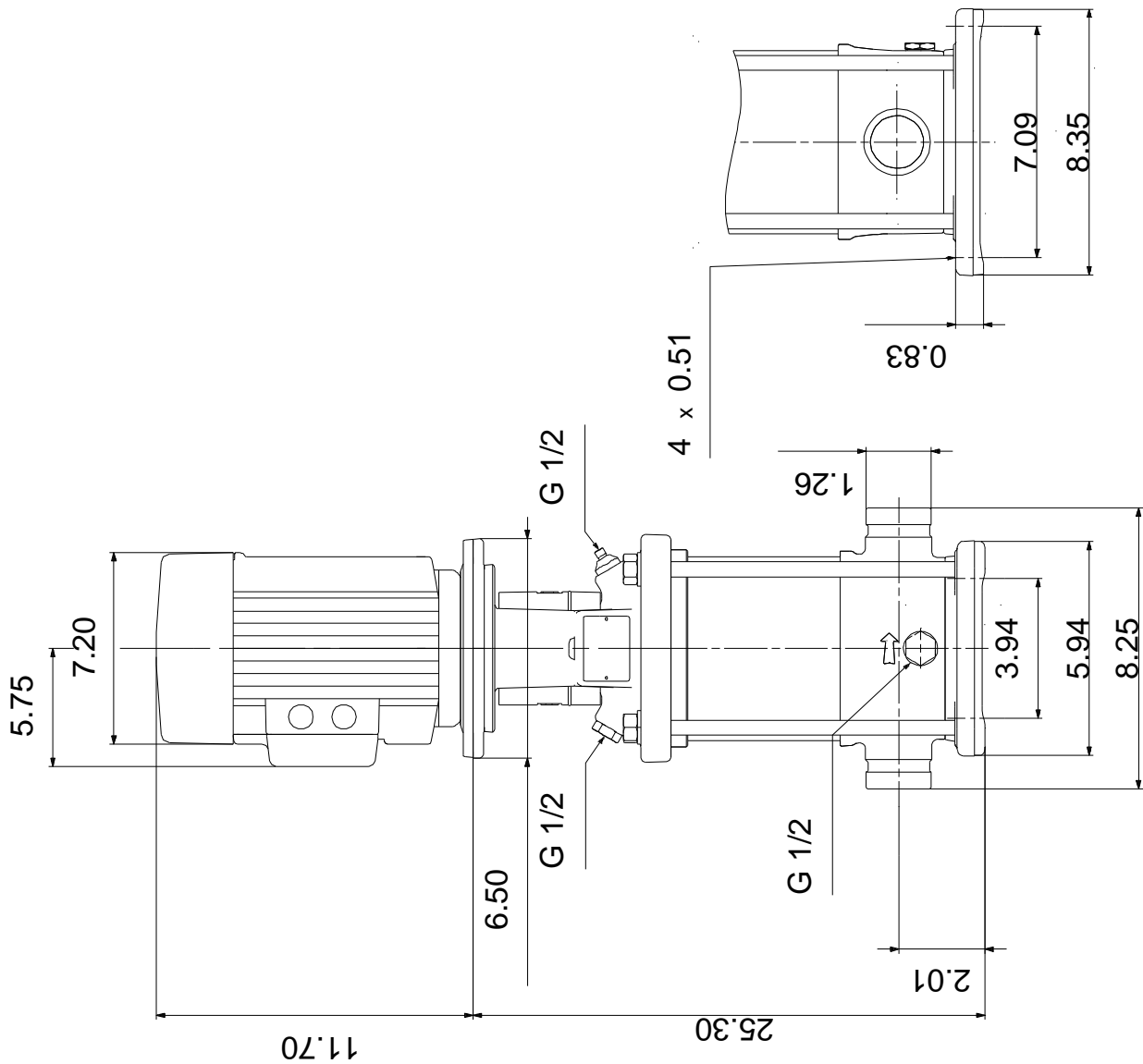

Note! All units are in [in] unless otherwise stated.
Disclaimer: This simplified dimensional drawing does not show all details.

96081622 CRN 1S-23 A-P-A-E-HQQE 60 Hz

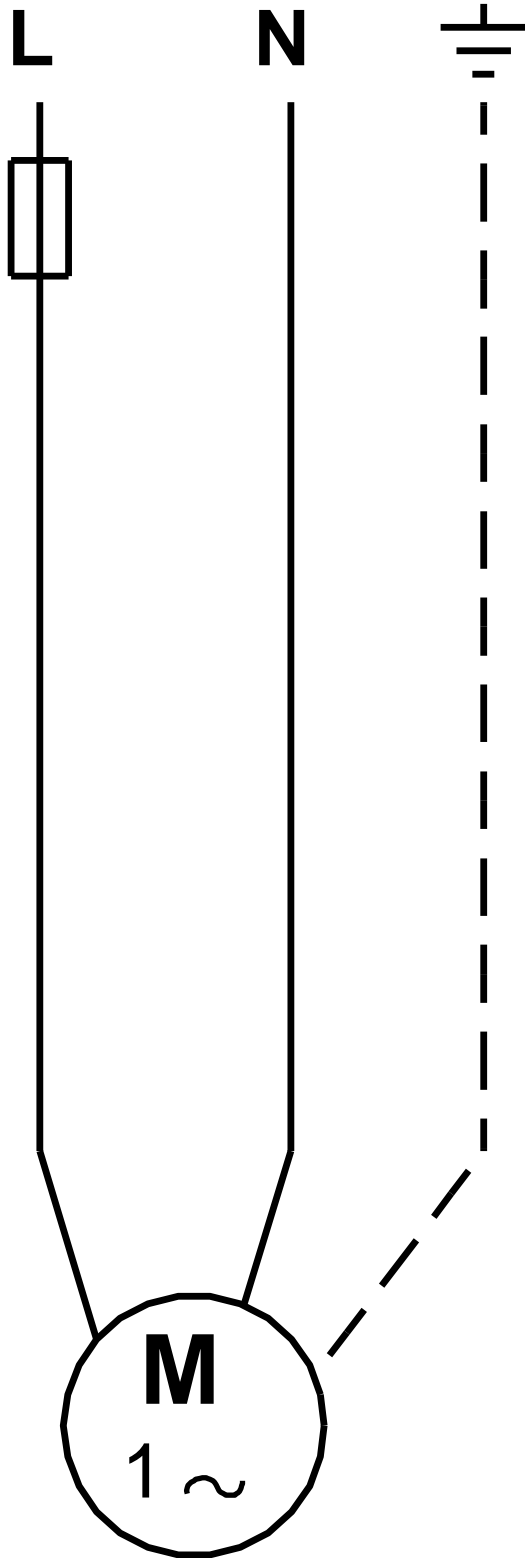

All units are [in] unless otherwise presented.