

Count	Description
1	<p data-bbox="225 338 536 367">CRN 1S-23 A-P-A-V-HQQV</p>  <p data-bbox="225 663 491 692">Product No.: 96081718</p> <p data-bbox="225 694 748 779">Vertical, non-self-priming, multistage, in-line, centrifugal pump for installation in pipe systems and mounting on a foundation.</p> <p data-bbox="225 810 703 840">The pump has the following characteristics:</p> <ul data-bbox="264 842 782 1016" style="list-style-type: none"> - Impellers, intermediate chambers and outer sleeve are made of - Pump head cover and base are made of - The shaft seal has assembly length according to EN 12756. - Power transmission is via cast iron split coupling. <p data-bbox="225 1048 424 1077">flanges/couplings.</p> <p data-bbox="225 1108 600 1137">The motor is a 3-phase AC motor.</p> <p data-bbox="225 1169 336 1198">Controls:</p> <p data-bbox="225 1200 660 1229">Frequency converter: NONE</p> <p data-bbox="225 1261 312 1290">Liquid:</p> <p data-bbox="225 1292 660 1321">Pumped liquid: Water</p> <p data-bbox="225 1323 715 1352">Liquid temperature range: -4 .. 194 °F</p> <p data-bbox="225 1355 651 1384">Selected liquid temperature: 68 °F</p> <p data-bbox="225 1386 708 1415">Density: 62.29 lb/ft³</p> <p data-bbox="225 1447 352 1476">Technical:</p> <p data-bbox="225 1478 695 1507">Rated pump speed: 3466 rpm</p> <p data-bbox="225 1509 735 1538">Rated flow: 4.84 US gpm</p> <p data-bbox="225 1541 676 1570">Rated head: 424.9 ft</p> <p data-bbox="225 1572 676 1601">Pump orientation: Vertical</p> <p data-bbox="225 1603 660 1632">Shaft seal arrangement: Single</p> <p data-bbox="225 1635 660 1664">Code for shaft seal: HQQV</p> <p data-bbox="225 1666 676 1695">Approvals on nameplate: CURUS</p> <p data-bbox="225 1697 788 1727">Curve tolerance: ISO9906:2012 3B</p> <p data-bbox="225 1758 344 1787">Materials:</p> <p data-bbox="225 1789 751 1848">Base: Stainless steel EN 1.4408 AISI 316</p> <p data-bbox="225 1850 751 1939">Impeller: Stainless steel EN 1.4401 AISI 316</p> <p data-bbox="225 1942 632 1971">Bearing: SIC</p> <p data-bbox="225 2002 368 2031">Installation:</p> <p data-bbox="225 2033 663 2063">Maximum ambient temperature: 140 °F</p> <p data-bbox="225 2065 703 2094">Maximum operating pressure: 362.59 psi</p>

Count	Description
	<p>Max pressure at stated temperature: 363 psi / 194 °F 363 psi / -4 °F</p> <p>Type of connection: PJE Size of inlet connection: DN 32 Size of suction port: 1 1/4 inch Size of outlet connection: DN 32 Size of outlet port: 1 1/4 inch Pressure rating for pipe connection: PN 50 Flange size for motor: 56C</p> <p>Electrical data:</p> <p>Motor standard: NEMA Motor type: 80CA IE Efficiency class: NEMA Premium / IE3 60Hz Rated power - P2: 1.5 HP Power (P2) required by pump: 1.5 HP Main frequency: 60 Hz Rated voltage: 3 x 208-230YY/460Y V Service factor: 1.15 Rated current: 4,45-4,3/2,16 A Starting current: 720 % Cos phi - power factor: 0.84-0.78 Rated speed: 3440-3480 rpm IE efficiency: IE3 84,1% Motor efficiency at full load: 84.9 % Motor efficiency at 3/4 load: 81.0 % Motor efficiency at 1/2 load: 78.5 % Number of poles: 2 Enclosure class (IEC 34-5): 55 Dust/Jetting Insulation class (IEC 85): F Motor Number: 98976607</p> <p>Others:</p> <p>Net weight: 60.3 lb Gross weight: 74.8 lb Shipping volume: 8.26 ft³ Country of origin: US Custom tariff no.: 8413.70.2040</p>



Company name:

Created by:

Phone:

Date:

8/6/2019

96081718 CRN 1S-23 A-P-A-V-HQQV 60 Hz

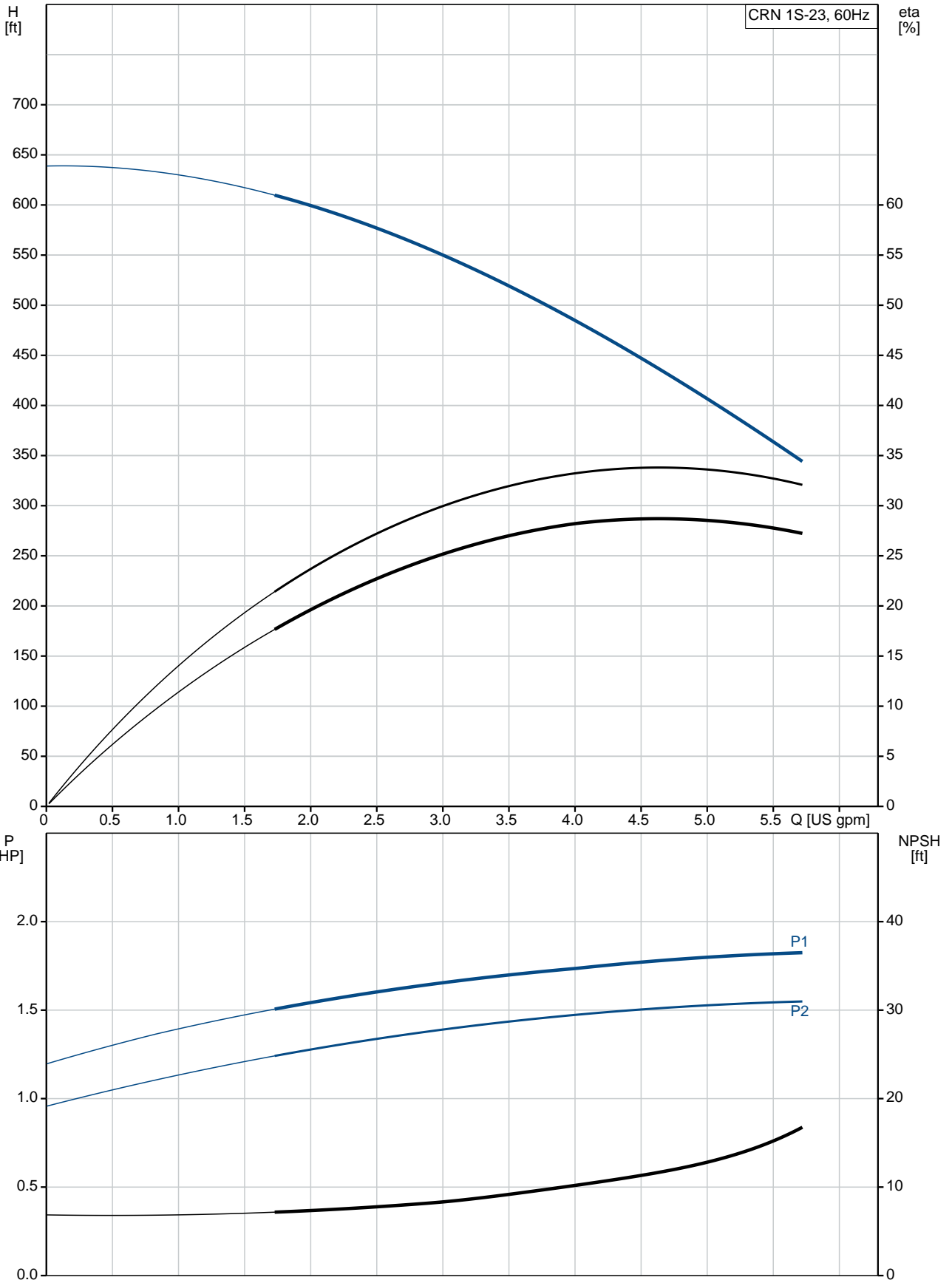

Description	Value
General information:	
Product name:	CRN 1S-23 A-P-A-V-HQQV
Product No.:	96081718
EAN:	5700395161625
Technical:	
Rated pump speed:	3466 rpm
Rated flow:	4.84 US gpm
Rated head:	424.9 ft
Head max:	640.5 ft
Stages:	23
Impellers:	23
Number of reduced-diameter impellers:	0
Low NPSH:	N
Pump orientation:	Vertical
Shaft seal arrangement:	Single
Code for shaft seal:	HQQV
Approvals on nameplate:	CURUS
Curve tolerance:	ISO9906:2012 3B
Pump version:	A
Model:	A
Cooling:	TEFC
Materials:	
Base:	Stainless steel EN 1.4408 AISI 316
Impeller:	Stainless steel EN 1.4401 AISI 316
Material code:	A
Code for rubber:	V
Bearing:	SIC
Installation:	
Maximum ambient temperature:	140 °F
Maximum operating pressure:	362.59 psi
Max pressure at stated temperature:	363 psi / 194 °F 363 psi / -4 °F
Type of connection:	PJE
Size of inlet connection:	DN 32
Size of suction port:	1 1/4 inch
Size of outlet connection:	DN 32
Size of outlet port:	1 1/4 inch
Pressure rating for pipe connection:	PN 50
Flange size for motor:	56C
Connect code:	P
Liquid:	
Pumped liquid:	Water
Liquid temperature range:	-4 .. 194 °F
Selected liquid temperature:	68 °F
Density:	62.29 lb/ft³
Electrical data:	
Motor standard:	NEMA
Motor type:	80CA
IE Efficiency class:	NEMA Premium / IE3 60Hz
Rated power - P2:	1.5 HP
Power (P2) required by pump:	1.5 HP
Main frequency:	60 Hz

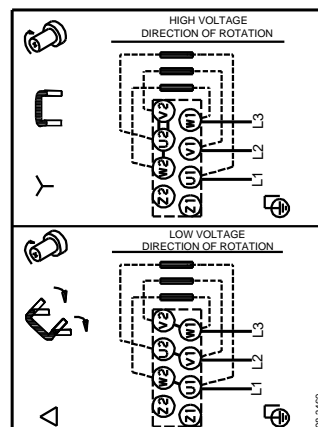
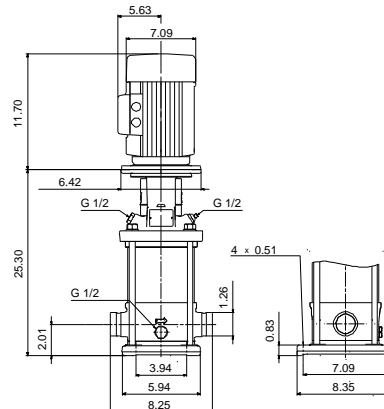
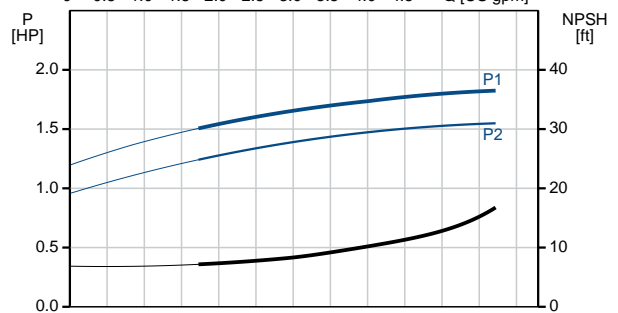
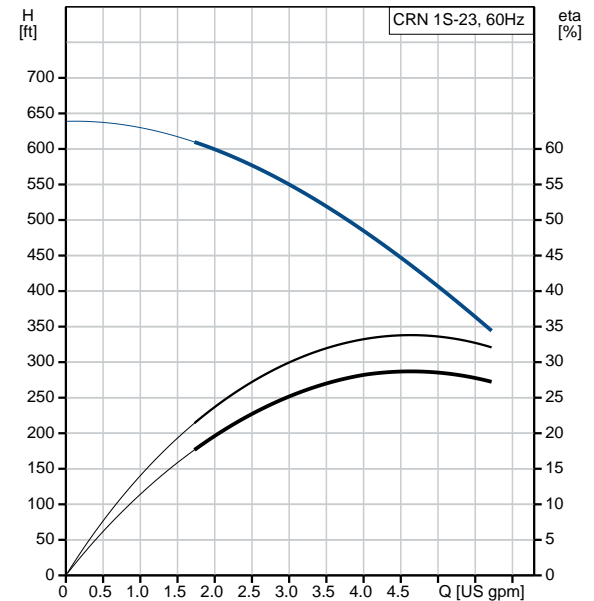



Company name:

Created by:

Phone:

Date:

8/6/2019

Description	Value
Rated voltage:	3 x 208-230YY/460Y V
Service factor:	1.15
Rated current:	4,45-4,3/2,16 A
Starting current:	720 %
Load current:	5,1-4,95/2,48 A
Cos phi - power factor:	0.84-0.78
Rated speed:	3440-3480 rpm
IE efficiency:	IE3 84,1%
Motor efficiency at full load:	84.9 %
Motor efficiency at 3/4 load:	81.0 %
Motor efficiency at 1/2 load:	78.5 %
Number of poles:	2
Enclosure class (IEC 34-5):	55 Dust/Jetting
Insulation class (IEC 85):	F
Motor protection:	NONE
Motor Number:	98976607
Controls:	
Frequency converter:	NONE
Others:	
Net weight:	60.3 lb
Gross weight:	74.8 lb
Shipping volume:	8.26 ft ³
Country of origin:	US
Custom tariff no.:	8413.70.2040

96081718 CRN 1S-23 A-P-A-V-HQQV 60 Hz

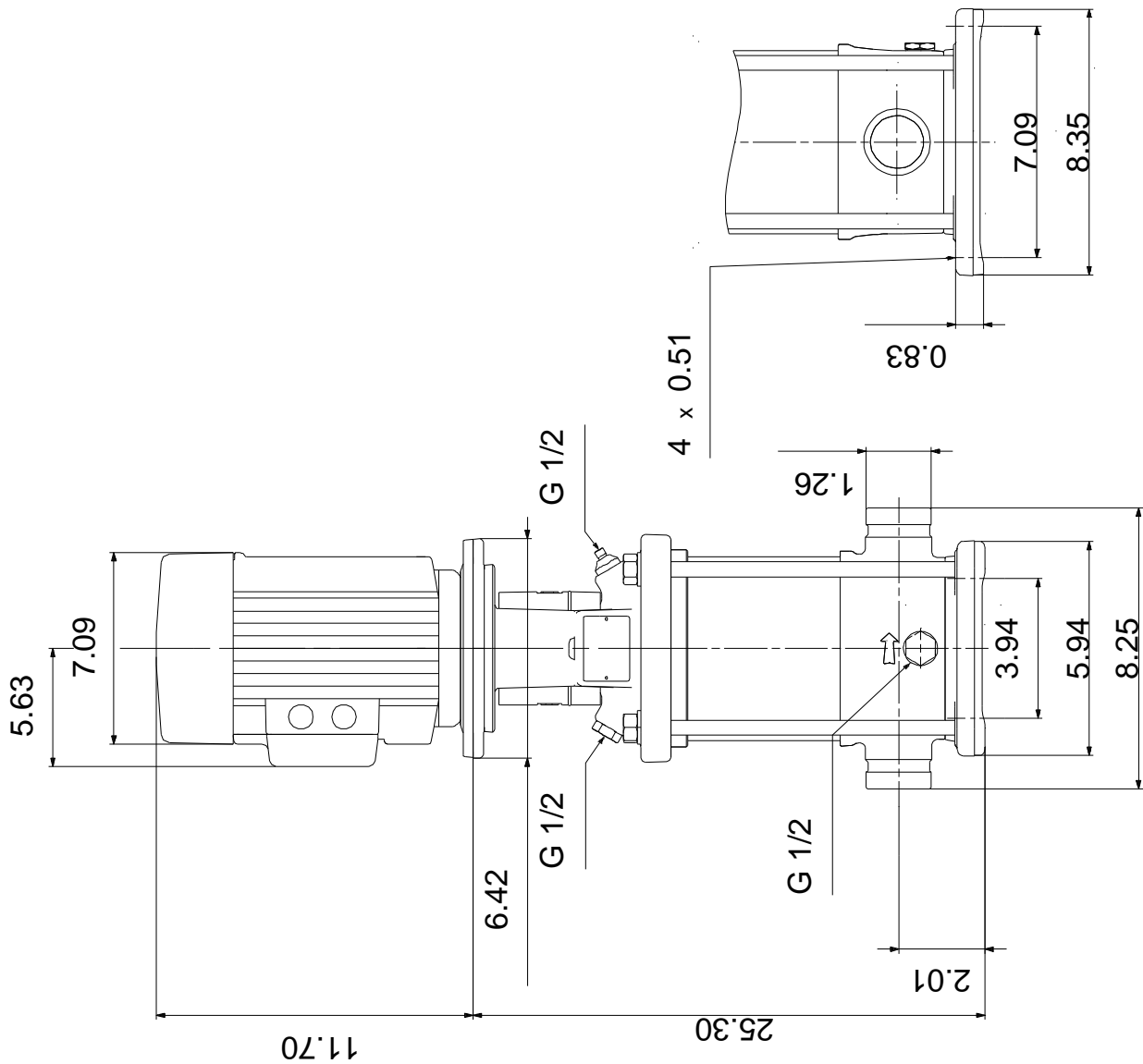

Note! All units are in [in] unless otherwise stated.
Disclaimer: This simplified dimensional drawing does not show all details.

96081718 CRN 1S-23 A-P-A-V-HQQV 60 Hz



All units are [in] unless otherwise presented.