

Pump Performance Curve

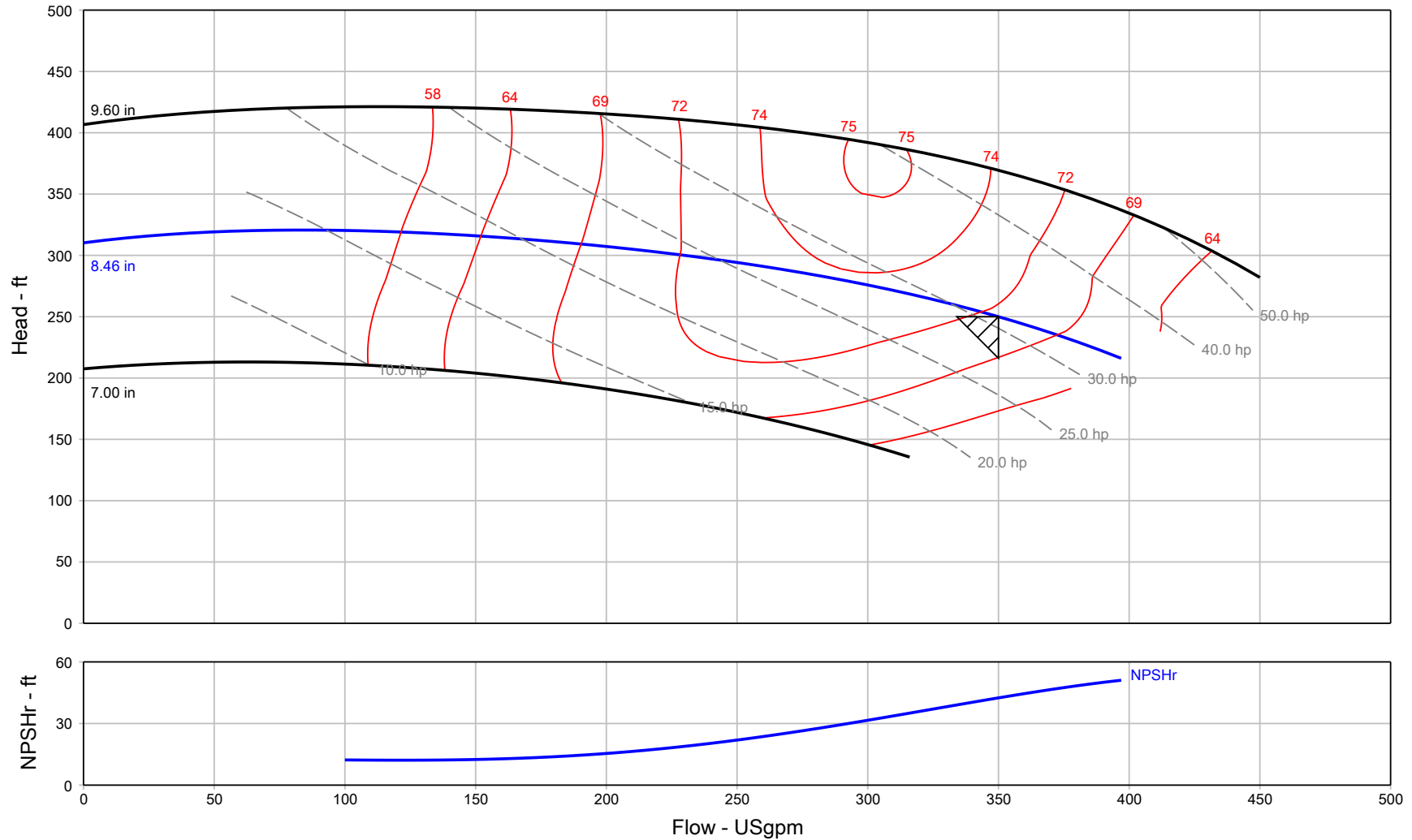

Project name : 1119494	Tag Number : 003	Flow, rated : 350.0 USgpm
Consulting engineer :	Service :	Differential head / pressure, rated : 250.0 ft
Customer :	Model : 15959 LC	Rated power (based on duty point) : 30.91 hp
Customer ref. / PO :	Quantity : 1	Max power (non-overloading) : 33.37 hp
Project Number / ID : 1119494	Quoted By (Sales Office) : PFC EQUIPMENT INC	Efficiency : 71.47 %
Date last saved : 02/19/2020 3:55 PM	Quoted By (Sales Engineer) : Corey Nath	Impeller diameter, rated : 8.46 in
Based on curve number : RC9846-SS Rev 0	Stages : 1	PEI (CL) : 0.83
	Speed, rated : 3550 rpm	ER (CL) : 17

Multi-Speed Performance Curve

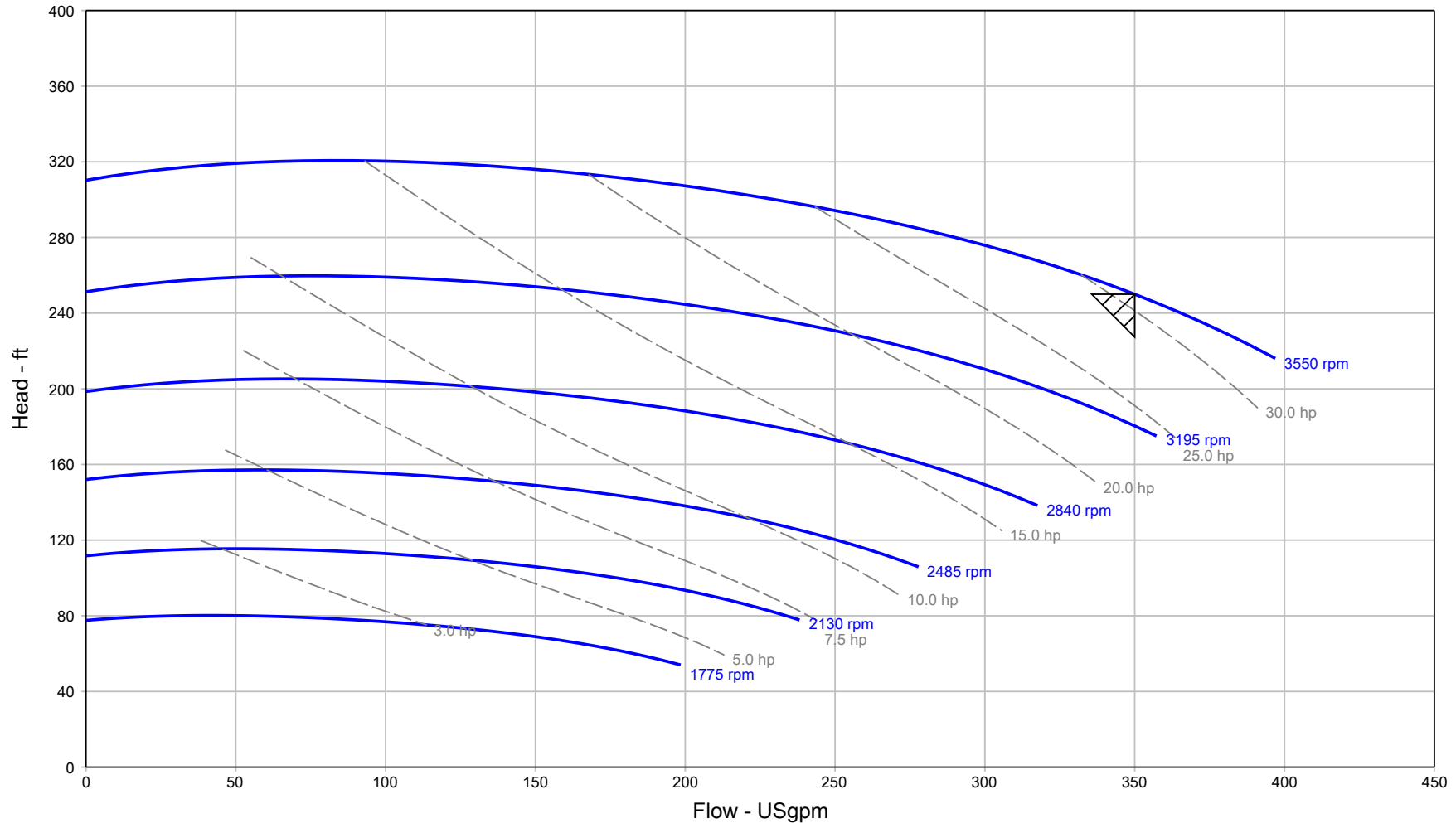

Project name	: 1119494	Tag Number	: 003	Speed, rated	: 3550 rpm
Consulting engineer	:	Service	:	Flow, rated	: 350.0 USgpm
Customer	:	Model	: 15959 LC	Differential head / pressure, rated	: 250.0 ft
Customer ref. / PO	:	Quantity	: 1	Fluid density, rated / max	: 1.000 / 1.000 SG
Project Number / ID	: 1119494	Quoted By (Sales Office)	: PFC EQUIPMENT INC	Viscosity	: 1.00 cP
Date last saved	: 02/19/2020 3:55 PM	Quoted By (Sales Engineer)	: Corey Nath	Cq/Ch/Ce/Cn [ANSI/HI 9.6.7-2010]	: 1.00 / 1.00 / 1.00 / 1.00
		Stages	: 1	Based on curve number	: RC9846-SS Rev 0

Construction Datasheet

Project name	: 1119494	Tag Number	: 003
Consulting engineer	:	Service	:
Customer	: PFC EQUIPMENT INC	Model	: 15959 LC
Customer ref. / PO	:	Quantity	: 1
Quote Number / ID	: 1119494	Quoted By (Sales Office)	: PFC EQUIPMENT INC
Date last saved	: 02/19/2020 3:55 PM	Quoted By (Sales Engineer)	: Corey Nath

Construction				Motor Information	
--------------	--	--	--	-------------------	--

Nozzle	Size (in.)	Nozzle Configuration	Pos'n	Manufacturer	: Baldor
Suction	2	NPS	End	Frame Size	: 324JM
Discharge	1.5	NPS	Top	Power	: 40.00 hp

Orientation / Configuration	: Horizontal	RPM	: 3600 rpm
Rotation	: Clockwise	Enclosure	: TEFC
Wear Ring Configuration	: Single - Case	Operating Power Supply	: 230/460/3/60
Discharge Elbow Size	: -	Efficiency	: Premium
Subplate	: -	Service factor	: 1.15
Sump Depth (feet)	: -	Motor Application	: General Purpose
Bearing Frame	: -	Motor Options/Accessories	: -
Bearing Frame Foot	: -	Cord Length (feet)	: -
Bearing Type (Radial/Thrust)	: In motor		
Bearing Lubrication	: -		
Thrust Bearing	: -		
Intermediate Bearing	: -		
Lower Bearing	: -		
Bearing Housing Accessories	: -		
PACO Construction code	: 10-15959-140008-2891P		

Materials	
-----------	--

Case	: Cast Iron, ASTM A48 - Class 30
Motor Bracket	: Cast Iron, ASTM-A48, CL 30
Impeller	: Stainless Steel, AISI-304 (H304)
Impeller Cap Screw and Washer	: Stainless Steel, AISI-303
Impeller Key	: Stainless Steel, AISI 316
Case wear ring	: Tin Bronze, ASTM B584-90500 (B18)
Impeller wear ring	: -
Pump Shaft	: Steel, AISI-1040
Sleeve	: Bronze, III932, C89835
Line Shaft	: -
Column	: -
Discharge Pipe	: -
Discharge Elbow	: -
Suction Elbow	: -
Subplate	: -
Hardware	: Steel, Grade 5
O Rings	: Buna N
Pump Coatings	: Standard Manufacturer's Paint

Baseplate, Coupling and Guard	
-------------------------------	--

Baseplate	: Not Applicable
Drip Pan	: -
Coupling	: -
Guard	: Not Applicable

Seal & Packing Construction	
-----------------------------	--

Sealing Method	: Single Seal, Type 21S
Seal Material	: Buna Carbon Ceramic SS-Spring and Hardware
Packing Gland	: -
Lantern Ring	: -
Recirculation Lines	: None

Weights (Approx.)	
-------------------	--

Pump	: 70.00 lb
Baseplate	: -
Driver	: 518.0 lb
Estimated Shipping gross weight	: 588.0 lb

General Arrangement

Project name	: 1119494	Tag Number	: 003
Consulting engineer	:	Service	:
Customer	: PFC EQUIPMENT INC	Model	: 15959 LC
Customer ref. / PO	:	Quantity of pumps	: 1
Quote Number / ID	: 1119494	Quoted By (Sales Office)	: PFC EQUIPMENT INC
Date last saved	: 02/19/2020 3:55 PM	Quoted By (Sales Engineer)	: Corey Nath

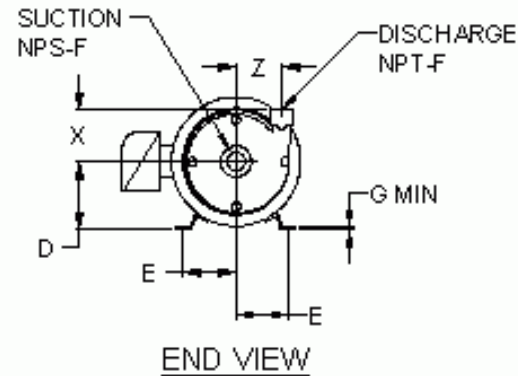
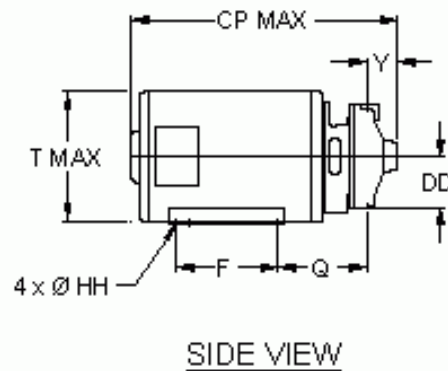
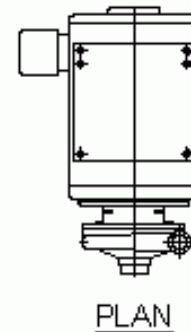

NOT FOR CONSTRUCTION, Unless certified and referenced on order

Units	Frame	Suct(in)	Disch(in)	CP	D	DD	E	F	G	HH	Q	T	X	Y	Z	Weight ea
inches	324JM	2	1.5	33.00	8.00	6.00	6.25	10.50	0.31	0.66	10.38	15.13	6.00	3.62	5.38	588.0

Conditions of Service			Motor Data			
Flow: 350.0 USgpm	Fluid: Cold Water	HP: 40	Encl: TEFC	Phase: 3	Efficiency: Premium	
TDH: 250.0 ft	Temp.: 68.00 deg F	RPM: 3550 rpm	Hz: 60	Voltage: 230/460	S.F.: 1.15	