

Pump Performance Curve

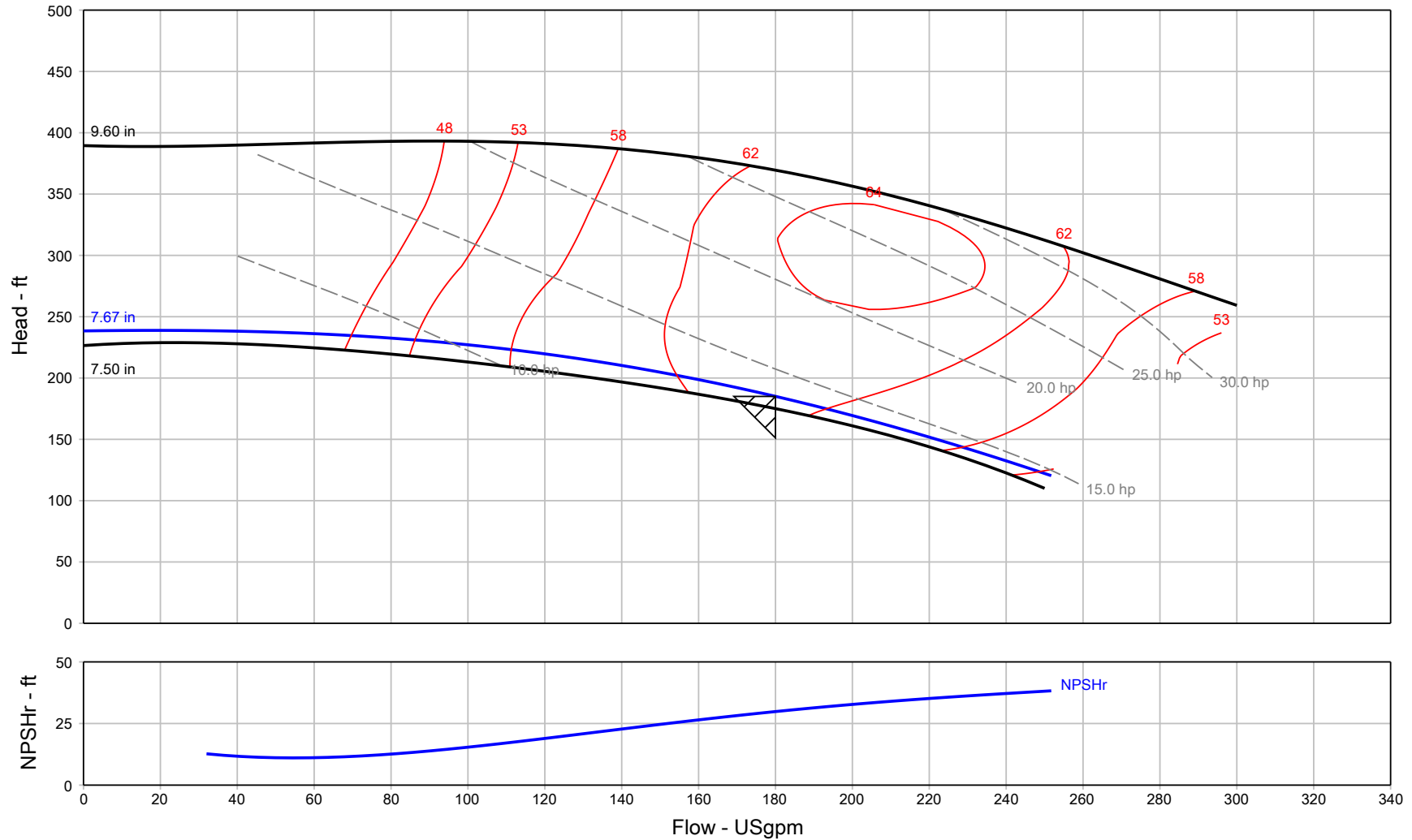

Project name : Default	Tag Number : 001	Flow, rated : 180.0 USgpm
Consulting engineer :	Service :	Differential head / pressure, rated : 185.0 ft
Customer :	Model : 15955 LF	Rated power (based on duty point) : 13.48 hp
Customer ref. / PO :	Quantity : 1	Max power (non-overloading) : 14.72 hp
Quote Number / ID : 1075123	Quoted By (Sales Office) : PFC EQUIPMENT INC	Efficiency : 62.40 %
Date last saved : 02/24/2020 3:35 PM	Quoted By (Sales Engineer) : Corey Nath	Impeller diameter, rated : 7.67 in
Based on curve number : RC1950-SS Rev 1	Stages : 1	PEI (CL) : 0.89
	Speed, rated : 3530 rpm	ER (CL) : 11

Multi-Speed Performance Curve

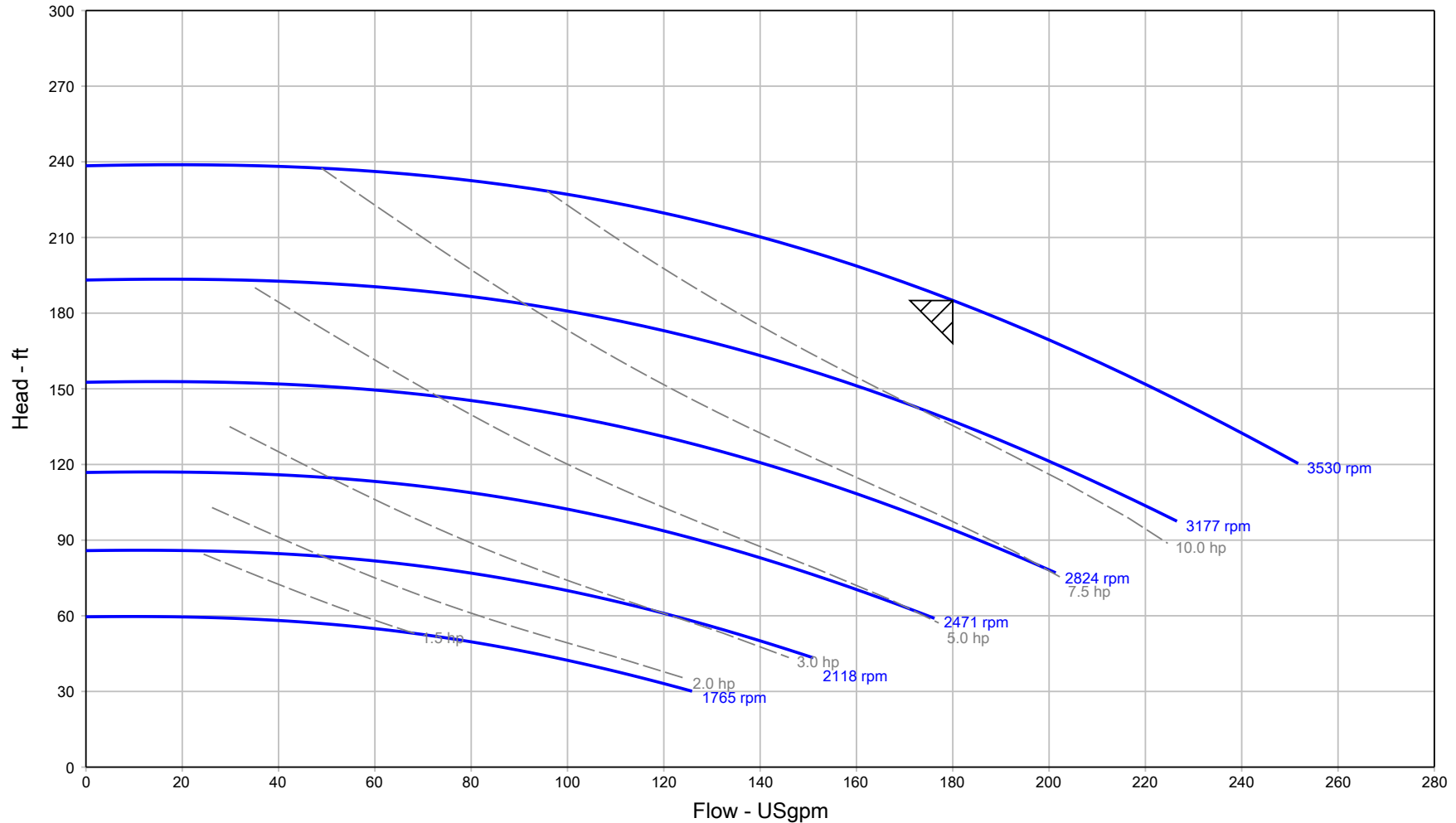

Project name	: Default	Tag Number	: 001	Speed, rated	: 3530 rpm
Consulting engineer	:	Service	:	Flow, rated	: 180.0 USgpm
Customer	:	Model	: 15955 LF	Differential head / pressure, rated	: 185.0 ft
Customer ref. / PO	:	Quantity	: 1	Fluid density, rated / max	: 1.000 / 1.000 SG
Quote Number / ID	: 1075123	Quoted By (Sales Office)	: PFC EQUIPMENT INC	Viscosity	: 1.00 cP
Date last saved	: 02/24/2020 3:35 PM	Quoted By (Sales Engineer)	: Corey Nath	Cq/Ch/Ce/Cn [ANSI/HI 9.6.7-2010]	: 1.00 / 1.00 / 1.00 / 1.00
		Stages	: 1	Based on curve number	: RC1950-SS Rev 1

Construction Datasheet

Project name	: Default	Tag Number	: 001
Consulting engineer	:	Service	:
Customer	: PFC EQUIPMENT INC	Model	: 15955 LF
Customer ref. / PO	:	Quantity	: 1
Quote Number / ID	: 1075123	Quoted By (Sales Office)	: PFC EQUIPMENT INC
Date last saved	: 02/24/2020 3:35 PM	Quoted By (Sales Engineer)	: Corey Nath
Construction		Motor Information	
Nozzle	Size (in.)	Nozzle Configuration	Pos'n
Suction	2	NPS	End
Discharge	1.5	NPS	Top
Orientation / Configuration	: Horizontal	Manufacturer	: Baldor
Rotation	: Clockwise	Frame Size	: 254T
Wear Ring Configuration	: Single - Case	Power	: 15.00 hp
Discharge Elbow Size	: -	RPM	: 3600 rpm
Subplate	: -	Enclosure	: TEFC
Sump Depth (feet)	: -	Operating Power Supply	: 230/460/3/60
Bearing Frame	: 3P	Efficiency	: Premium
Bearing Frame Foot	: -	Service factor	: 1.15
Bearing Type (Radial/Thrust)	: Ball/Ball	Motor Application	: General Purpose
Bearing Lubrication	: Greased for life	Motor Options/Accessories	: -
Thrust Bearing	: -	Cord Length (feet)	: -
Intermediate Bearing	: -	Materials	
Lower Bearing	: -	Case	: Cast Iron, ASTM A48 - Class 30
Bearing Housing Accessories	: -	Motor Bracket	: -
PACO Construction code	: 11-15955-133P08-2821P	Impeller	: Stainless Steel, AISI-304 (H304)
Baseplate, Coupling and Guard		Impeller Cap Screw and Washer	: Stainless Steel, AISI-303
Baseplate	: Welded Steel Fabrication	Impeller Key	: Stainless Steel, AISI 316
Drip Pan	: Drip Pan	Case wear ring	: Tin Bronze, ASTM B584-90500 (B18)
Coupling	: Woods Sureflex Type S (elastomeric) 6S	Impeller wear ring	: Not Applicable
Guard	: OSHA Approved	Pump Shaft	: Stressproof Steel, AISI 1144
Seal & Packing Construction		Sleeve	: Bronze, III932, C89835
Sealing Method	: Single Seal, Type 21S	Line Shaft	: -
Seal Material	: Buna Carbon Ceramic SS-Spring and Hardware	Column	: -
Packing Gland	: -	Discharge Pipe	: -
Lantern Ring	: -	Discharge Elbow	: -
Recirculation Lines	: None	Suction Elbow	: -
Weights (Approx.)		Subplate	: -
Pump	: 110.0 lb	Hardware	: Steel, Grade 5
Baseplate	: 80.00 lb	O Rings	: Buna N
Driver	: 270.0 lb	Pump Coatings	: Standard Manufacturer's Paint
Estimated Shipping gross weight	: 460.0 lb		

General Arrangement

Project name	: Default	Tag Number	: 001
Consulting engineer	:	Service	:
Customer	: PFC EQUIPMENT INC	Model	: 15955 LF
Customer ref. / PO	:	Quantity of pumps	: 1
Quote Number / ID	: 1075123	Quoted By (Sales Office)	: PFC EQUIPMENT INC
Date last saved	: 02/24/2020 3:35 PM	Quoted By (Sales Engineer)	: Corey Nath

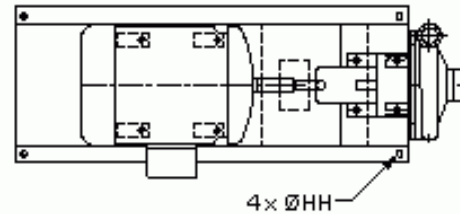

PLAN VIEW

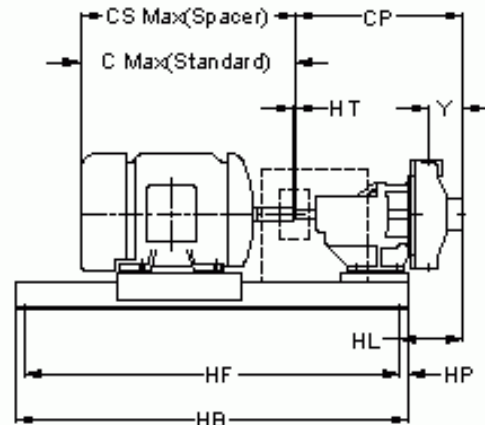

SIDE VIEW

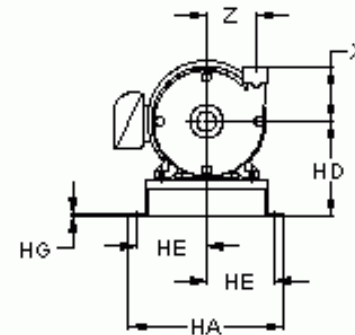

END VIEW

NOT FOR CONSTRUCTION, Unless certified and referenced on order

Units	Frame	Ped	Suct(in)	Disch(in)	C	CP	D	HA	HB	HD	HE	HF	HG	HH	HL	HP	HT	MU	N	Q	U	X	Y	Z	Weight ea
inches	254T	3P	2	1.5	27.00	18.20	6.25	17.00	38.13	10.38	7.50	36.13	0.25	0.63	6.66	1.00	0.69	1.63	2.25	3.50	0.88	6.00	3.63	5.38	460.0

Conditions of Service				Motor Data			
Flow: 180.0 USgpm	Fluid: Cold Water	HP: 15	Encl: TEFC	Phase: 3	Efficiency: Premium		
TDH: 185.0 ft	Temp.: 68.00 deg F	RPM: 3530 rpm	Hz: 60	Voltage: 230/460	S.F.: 1.15		