



Customer	Date	01.05.2020
Contact	Project	
Phone number	Project no.	
Email		

2ED51F4GA

Operating data

Pump type	Effluent	Fluid	Water
No. of pumps / Reserve	1 / 0	Operating temperature t A	°F 39.2
Nominal flow	US g.p.m. 0	pH-value at t A	7
Nominal head	ft 0	Density at t A	lb/ft ³ 62.4
Static head	ft 0	Kin. viscosity at t A	ft ² /s 1.689E-5
Inlet pressure	psi 0	Vapor pressure at t A	psi 14.5
Environmental temperature	°F 68	Solids	0
Available system NPSH	ft 0	Altitude	ft 0

Pump data

Make	Goulds Water Technology	Nominal	US g.p.m. ()
Speed	rpm 3500	Flow	Max- US g.p.m. 94.8
No. of stages	1		Min- US g.p.m.
Max. casing pressure	psi	Nominal	ft
Max. working pressure	psi 55.4	Head	at Qmax ft 10.8
Head H(Q=0)	ft 130		at Qmin ft 127.8
Weight	lb On demand	Shaft power	hp ()
	Max. inch 5 1/2	Max. shaft power	hp 1.6
Impeller R	designed inch 5 1/2	Efficiency	%
	Min. inch 3 9/16	NPSH 3%	ft

Shaft Seal

2ED	Effluent
2ED Mechanical Seal	
1 - Rotating (Upper)	Carbon
2 - Stationary (Upper)	Ceramic
3 - Elastomers (Upper)	BUNA
4 - Metal Components (Upper)	Stainless Steel
5 - Rotating (Lower)	Silicon Carbide
6 - Stationary (Lower)	Silicon Carbide
7 - Elastomers (Lower)	BUNA
8 - Metal Components (Lower)	Stainless Steel

Motor data

Manufacturer	Regal Beloit	Electric voltage	460 V	Speed	3500 rpm	Insulation class	B
Specific design	3ph	Electric current	4.6 A	Frame size	48	Colour	RAL 5010
Type	119-49 44 (1.5HP/230/460V)						
Rated power	1.5 hp	Degree of protection	IP 55				

Remarks:

Customer	Date	01.05.2020
Contact	Project	
Phone number	Project no.	
Email		

2ED51F4GA



Pump Materials

100 - Casing	Cast Iron
101 - Impeller	Cast Iron
112A - Lower Ball Bearing	Steel
112B - Upper Ball Bearing	Steel
184 - Seal Housing	Cast Iron
218 - Insulating Oil	Turbine Oil - ASTM150
246 - Seal Sensor – Plug and Rod	Nylon/Brass
304 - Impeller Locknut - All	AISI 300 SS
338 - Motor	Stainless Steel Shaft
340 - Bearing Housing	Cast Iron
341 - Motor Cover	Cast Iron
351 - Casing Gasket	Composite
358 - Plug – Seal Housing ¼" NPT	AISI 300 SS
358E - Plug – Motor Cover 3/8" NPT	AISI 300 SS
361 - Retaining Ring	AISI 300 SS
361D - Seal Retainer	AISI 300 SS
372D - Hex Cap Screw – Housing to Casing	AISI 300 SS
376 - Capacitor (1 Phase Only) – Start	–
412M - O-ring – Motor Cover	BUNA-N, AS 568A-166
412P - O-ring – Seal/Bearing Housing	BUNA-N, AS 568A-163
457 - Wire Nut	Special Nylon Housing

Remarks:



Customer	Date	01.05.2020
Contact	Project	
Phone number	Project no.	
Email		

2ED51F4GA

Hydraulic Data

Operating Data Specification	Hydraulic data (duty point)	Impeller design
Flow 0 US g.p.m.	Flow	Impeller R 5 1/2"
Head 0 ft	Head	Frequency 60 Hz
Static head 0 ft		Speed 3500 rpm

Power datas referred to:
Water [100%] ; 39.2°F; 62.4lb/ft³; 1.69E-5ft²/s
Performance according to ISO 9906 - Annex A

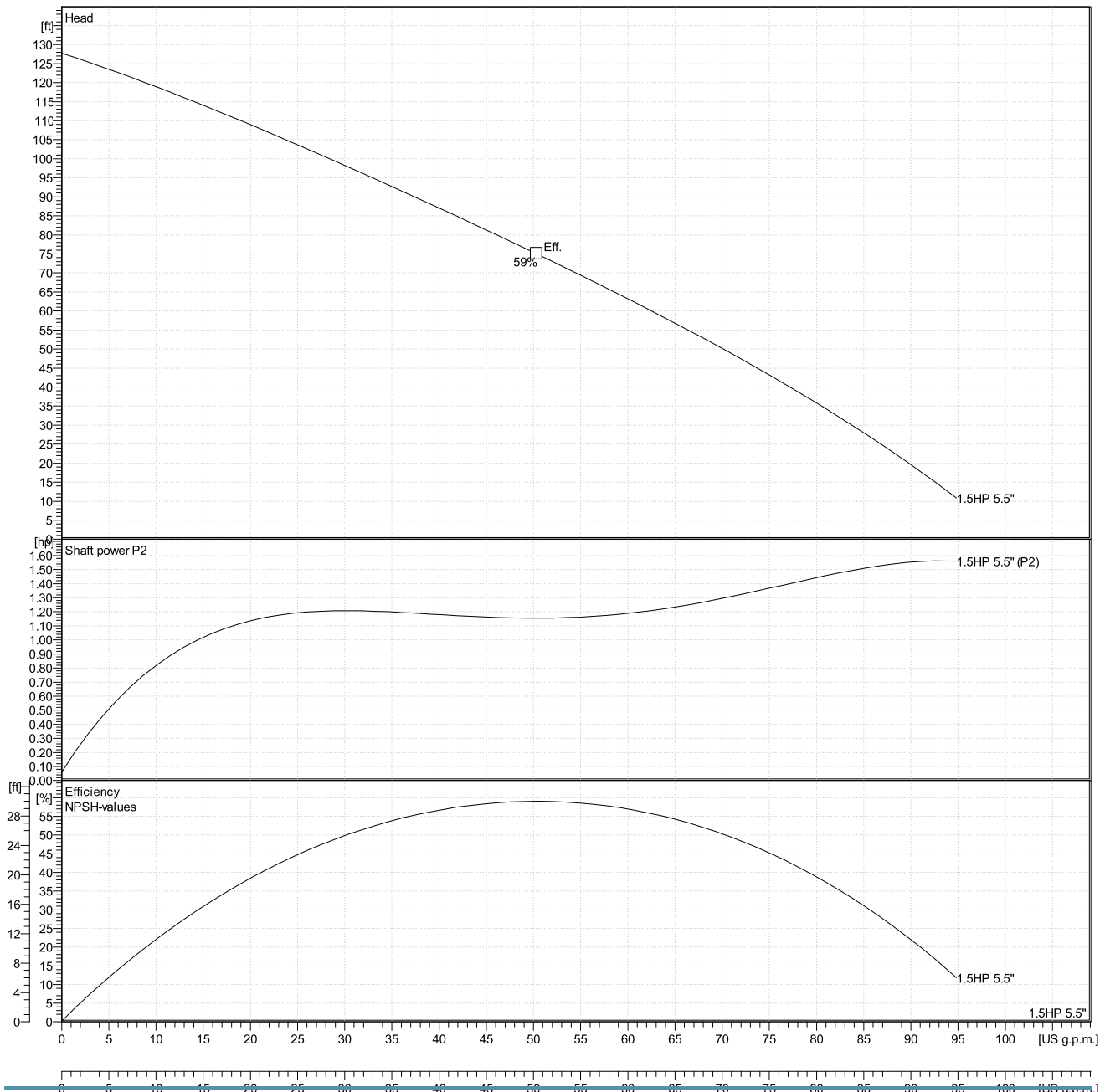



Customer	Date	01.05.2020
Contact	Project	
Phone number	Project no.	
Email		

2ED51F4GA

Drawing

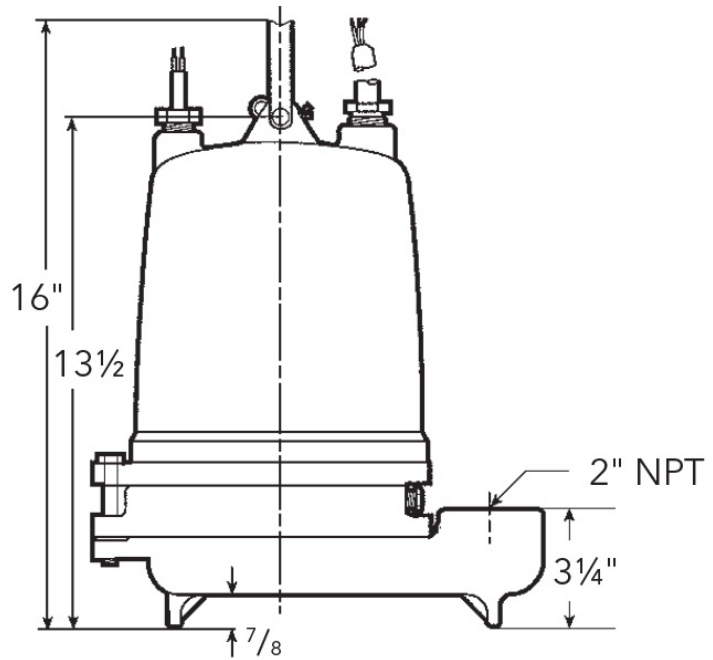
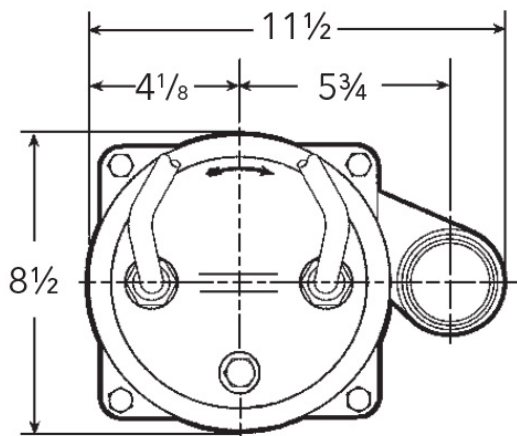

Dimensions inch

Discharge	2					Weight On demand
-----------	---	--	--	--	--	---------------------