

PROJECT: _____	UNIT TAG: _____	QUANTITY: _____
REPRESENTATIVE: _____	TYPE OF SERVICE: _____	DATE: _____
ENGINEER: _____	SUBMITTED BY: _____	DATE: _____
CONTRACTOR: _____	APPROVED BY: _____	DATE: _____
	ORDER NO.: _____	DATE: _____



5S05-9

Submersible pumps in stainless steel. EN 1.4301 (AISI 304). EN 1.4401 (AISI 316). EN 1.4539 (AISI 904L).
 Typical application: Ground water, Irrigation, Mining, Fountain, Off-shore etc.

Product photo could vary from the actual product

Conditions of Service	Pump Data	Motor Data
Flow: _____	Approvals: CE,EAC,CSACOMP,UR	Rated power - P2: 0.5 HP
Head: _____	Product number: 81595095	Rated voltage: 230 V
Efficiency: _____		Main frequency: 60 Hz
Liquid: Water		Enclosure class: IP68
Temperature: 68 °F		Insulation class: B
NPSH required: ft		Motor protection: CONTACT
Viscosity: _____		Thermal protection: internal
Specific Gravity: 1.000		Motor type: MS402

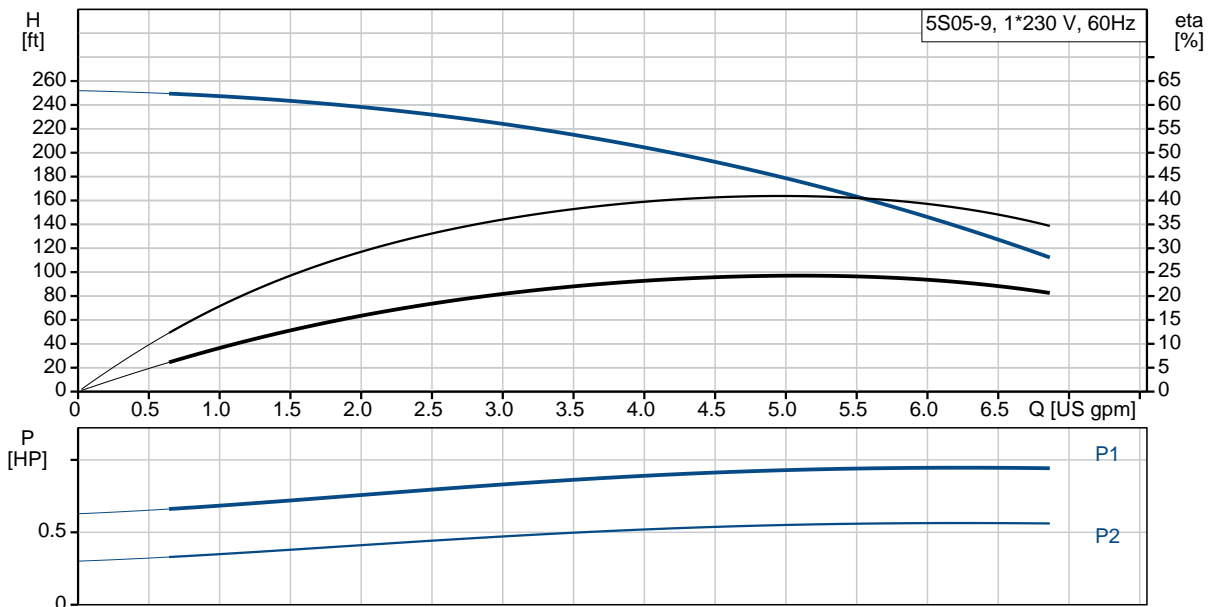

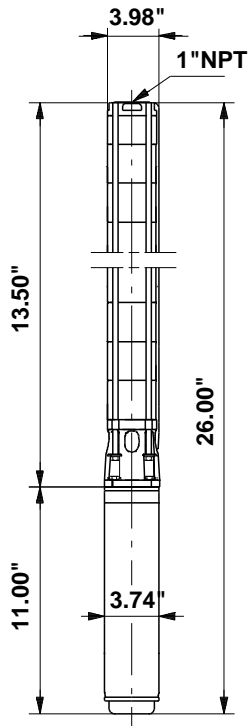

Materials:

- Pump: Stainless steel
EN 1.4301
AISI 304
- Impeller: Stainless steel
EN 1.4301
AISI 304
- Motor: Stainless steel
DIN W.-Nr. 1.4301
AISI 304



Company name:

Created by:

Phone:

Date:

5/14/2020

Count	Description
1	<p></p> <p>Product No.: 81595095 Multi-stage submersible pump for raw water supply, groundwater lowering and pressure boosting. The pump is suitable for pumping clean, thin, non-aggressive liquids without solid particles or fibers.</p> <p>The pump is made entirely of Stainless steel DIN W.-Nr. EN 1.4301 and suitable for horizontal and vertical installation. The pump is fitted with a built-in non-return valve.</p> <p>The motor is a 1-phase motor of the canned type with a sand shield, liquid-lubricated bearings and pressure-equalizing diaphragm.</p> <p>Liquid: Pumped liquid: Water Maximum liquid temperature: 140 °F Max liquid temperature at 0.15 m/sec: 104 °F Selected liquid temperature: 68 °F Density: 62.29 lb/ft³</p> <p>Technical: Pump speed on which pump data is based: 3450 rpm Rated flow: 4.4 US gpm Rated head: 173.9 ft Shaft seal for motor: LIPSEAL Approvals on nameplate: CE,EAC,CSACOMP,UR Curve tolerance: ISO9906:2012 3B Motor version: T40 Specification for shaft end: SPLINE</p> <p>Materials: Pump: Stainless steel EN 1.4301 AISI 304 Impeller: Stainless steel EN 1.4301 AISI 304</p>



Company name:

Created by:

Phone:

Date:

5/14/2020

Count	Description
	Motor: Stainless steel DIN W.-Nr. 1.4301 AISI 304
	Installation: Maximum ambient pressure: 217.56 psi Pump outlet: 1"NPT Motor diameter: 4 inch
	Electrical data: Motor type: MS402 Type of motor: RSIR Rated power - P2: 0.5 HP Power (P2) required by pump: 0.5 HP Main frequency: 60 Hz Rated voltage: 1 x 230 V Service factor: 1.60 Rated current: 6 A Starting current: 620 % Cos phi - power factor: 0.76 Rated speed: 3450 rpm Start. method: direct-on-line Enclosure class (IEC 34-5): IP68 Insulation class (IEC 85): B Built-in temperature transmitter: No Motor Number: 79952102
	Others: ErP status: EuP Standalone/Prod. Net weight: 21.6 lb Gross weight: 24 lb Shipping volume: 352 ft ³ Country of origin: US Custom tariff no.: 8413.70.2004



Company name:
Created by:
Phone:

Date: 5/14/2020

81595095 5S05-9 60 Hz

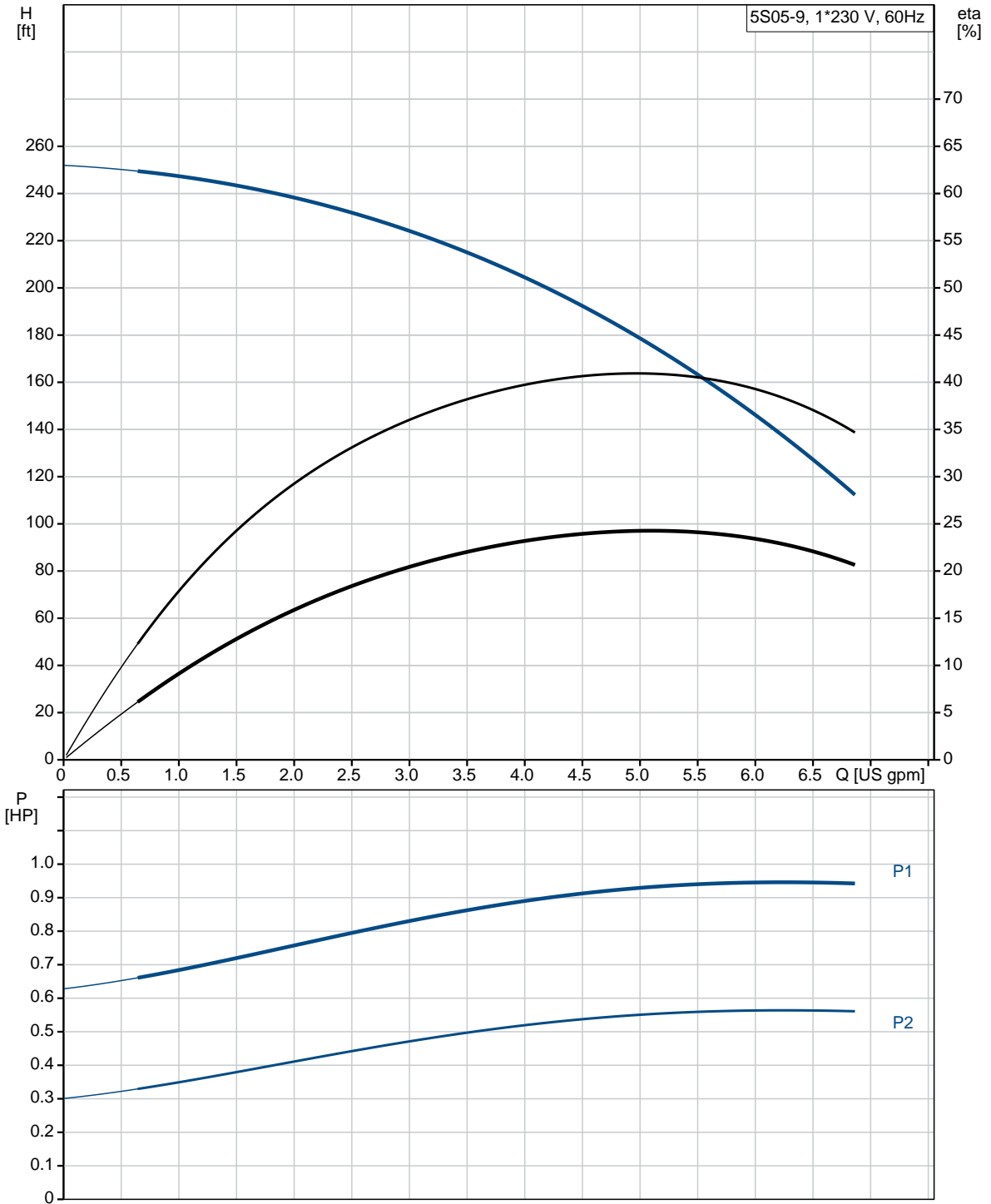



Company name:

Created by:

Phone:

Date:

5/14/2020

Description	Value
General information:	
Product name:	5S05-9
Product No.:	81595095
EAN:	5700394509763
	5700394509763
Technical:	
Pump speed on which pump data is based:	3450 rpm
Rated flow:	4.4 US gpm
Rated head:	173.9 ft
Stages:	9
Impeller reduc.:	NONE
Shaft seal for motor:	LIPSEAL
Approvals on nameplate:	CE,EAC,CSACOMP, UR
Curve tolerance:	ISO9906:2012 3B
Pump Number:	08010009
Model:	A
Valve:	YES
Motor version:	T40
Specification for shaft end:	SPLINE
Materials:	
Pump:	Stainless steel EN 1.4301 AISI 304
Impeller:	Stainless steel EN 1.4301 AISI 304
Motor:	Stainless steel DIN W.-Nr. 1.4301 AISI 304
Installation:	
Maximum ambient pressure:	217.56 psi
Pump outlet:	1"NPT
Motor diameter:	4 inch
Liquid:	
Pumped liquid:	Water
Maximum liquid temperature:	140 °F
Max liquid temperature at 0.15 m/sec:	104 °F
Selected liquid temperature:	68 °F
Density:	62.29 lb/ft³
Electrical data:	
Motor type:	MS402
Type of motor:	RSIR
Applic. motor:	GRUNDFOS
Rated power - P2:	0.5 HP
Power (P2) required by pump:	0.5 HP
KVA code:	R

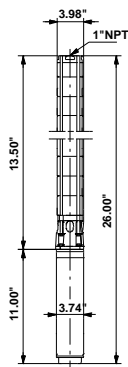
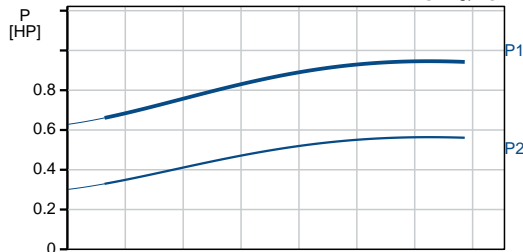
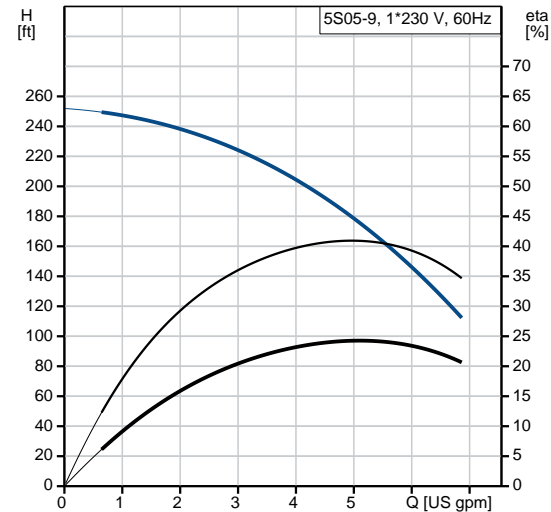



Company name:

Created by:

Phone:

Date:

5/14/2020

Description	Value
Main frequency:	60 Hz
Rated voltage:	1 x 230 V
Service factor:	1.60
Rated current:	6 A
Starting current:	620 %
Cos phi - power factor:	0.76
Rated speed:	3450 rpm
Axial load max:	772 lb
Start. method:	direct-on-line
Enclosure class (IEC 34-5):	IP68
Insulation class (IEC 85):	B
Motor protection:	CONTACT
Thermal protec:	internal
Built-in temperature transmitter:	No
Motor Number:	79952102
Others:	
ErP status:	EuP Standalone/Prod.
Net weight:	21.6 lb
Gross weight:	24 lb
Shipping volume:	352 ft ³
Sales region:	Namreg
Country of origin:	US
Custom tariff no.:	8413.70.2004



Company name:
Created by:
Phone:

Date: 5/14/2020

81595095 5S05-9 60 Hz

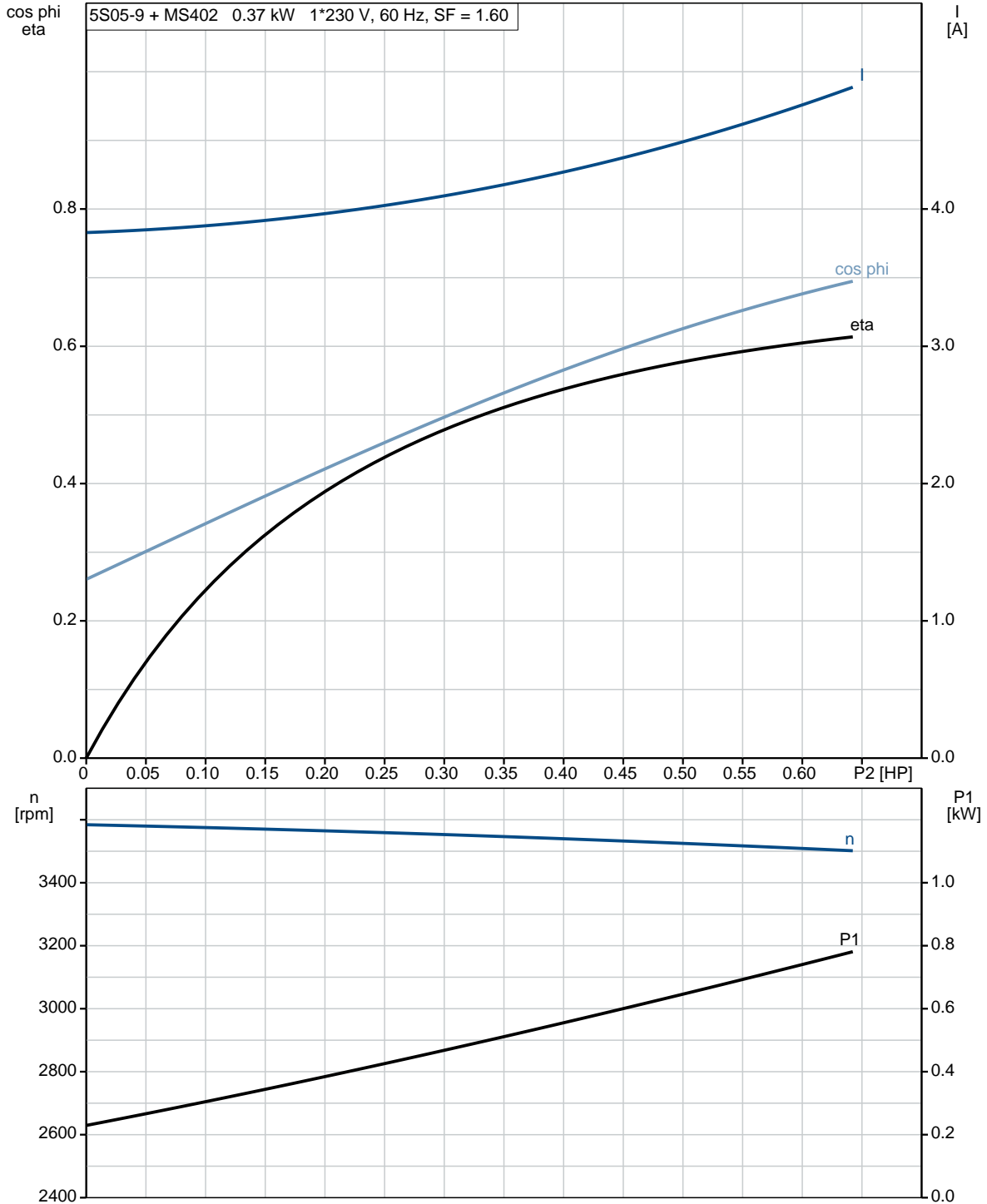



Company name:
Created by:
Phone:

Date: 5/14/2020

81595095 5S05-9 60 Hz

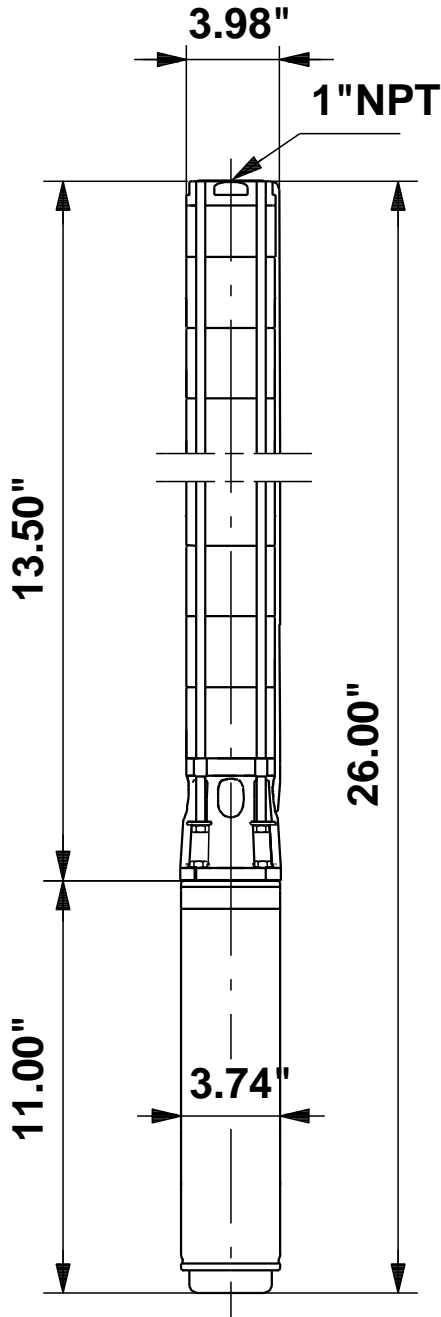

Note! All units are in [in] unless otherwise stated.
Disclaimer: This simplified dimensional drawing does not show all details.

81595095 5S05-9 60 Hz



All units are [in] unless otherwise presented.