

PROJECT: _____	UNIT TAG: _____	QUANTITY: _____
REPRESENTATIVE: _____	TYPE OF SERVICE: _____	DATE: _____
ENGINEER: _____	SUBMITTED BY: _____	DATE: _____
CONTRACTOR: _____	APPROVED BY: _____	DATE: _____
	ORDER NO.: _____	DATE: _____



### 10S05-9

Submersible pumps in stainless steel. EN 1.4301 (AISI 304). EN 1.4401 (AISI 316). EN 1.4539 (AISI 904L).  
 Typical application: Ground water, Irrigation, Mining, Fountain, Off-shore etc.

Product photo could vary from the actual product

Conditions of Service	Pump Data	Motor Data
Flow: _____	Approvals: CE,EAC,CSACOMP,UR	Rated power - P2: 0.5 HP
Head: _____	Product number: 9019209	Rated voltage: 115 V
Efficiency: _____		Main frequency: 60 Hz
Liquid: Water		Enclosure class: IP68
Temperature: 68 °F		Insulation class: B
NPSH required: ft		Motor protection: CONTACT
Viscosity: _____		Thermal protection: internal
Specific Gravity: 1.000		Motor type: MS402

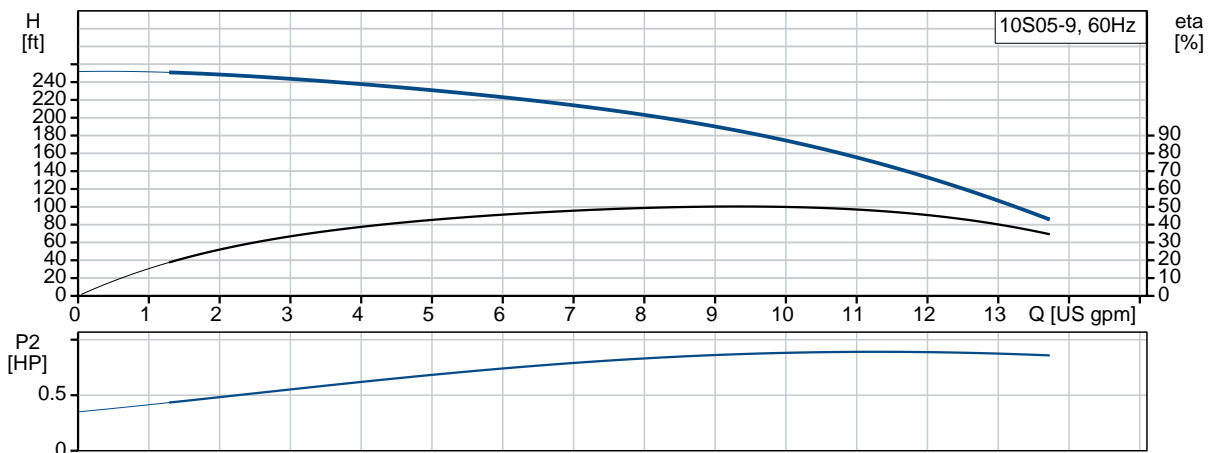

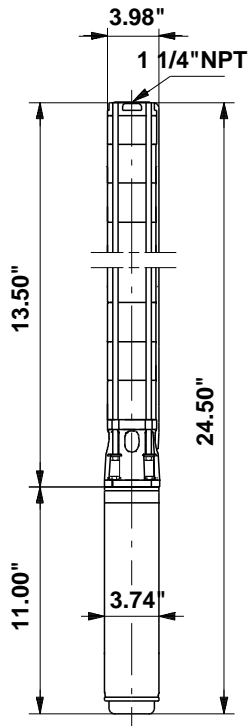

**Materials:**

- Pump: Stainless steel  
EN 1.4301  
AISI 304
- Impeller: Stainless steel  
EN 1.4301  
AISI 304
- Motor: Stainless steel  
DIN W.-Nr. 1.4301  
AISI 304

Count	Description																								
1	<p data-bbox="298 415 394 445"><b>10S05-9</b></p> <div data-bbox="446 457 532 928" style="text-align: center;">  </div> <p data-bbox="686 909 1138 932" style="text-align: center;">Product photo could vary from the actual product</p> <p data-bbox="298 940 548 968">Product No.: <a href="#">9019209</a></p> <p data-bbox="298 972 899 1087">Multi-stage submersible pump for raw water supply, groundwater lowering and pressure boosting. The pump is suitable for pumping clean, thin, non-aggressive liquids without solid particles or fibers.</p> <p data-bbox="298 1119 834 1234">The pump is made entirely of Stainless steel DIN W.-Nr. EN 1.4301 and suitable for horizontal and vertical installation. The pump is fitted with a built-in non-return valve.</p> <p data-bbox="298 1266 834 1354">The motor is a 1-phase motor of the canned type with a sand shield, liquid-lubricated bearings and pressure-equalizing diaphragm.</p> <p data-bbox="298 1383 383 1411"><b>Liquid:</b></p> <table data-bbox="298 1415 805 1533"> <tr> <td>Pumped liquid:</td> <td>Water</td> </tr> <tr> <td>Max liquid temperature at 0.15 m/sec:</td> <td>104 °F</td> </tr> <tr> <td>Selected liquid temperature:</td> <td>68 °F</td> </tr> <tr> <td>Density:</td> <td>62.29 lb/ft<sup>3</sup></td> </tr> </table> <p data-bbox="298 1562 423 1589"><b>Technical:</b></p> <table data-bbox="298 1593 924 1797"> <tr> <td>Rated flow:</td> <td>8.81 US gpm</td> </tr> <tr> <td>Rated head:</td> <td>173.9 ft</td> </tr> <tr> <td>Shaft seal for motor:</td> <td>LIPSEAL</td> </tr> <tr> <td>Approvals on nameplate:</td> <td>CE,EAC,CSACOMP,UR</td> </tr> <tr> <td>Curve tolerance:</td> <td>ISO9906:2012 3B</td> </tr> <tr> <td>Motor version:</td> <td>T40</td> </tr> <tr> <td>Specification for shaft end:</td> <td>SPLINE</td> </tr> </table> <p data-bbox="298 1827 415 1854"><b>Materials:</b></p> <table data-bbox="298 1858 818 1885"> <tr> <td>Pump:</td> <td>Stainless steel</td> </tr> </table>	Pumped liquid:	Water	Max liquid temperature at 0.15 m/sec:	104 °F	Selected liquid temperature:	68 °F	Density:	62.29 lb/ft <sup>3</sup>	Rated flow:	8.81 US gpm	Rated head:	173.9 ft	Shaft seal for motor:	LIPSEAL	Approvals on nameplate:	CE,EAC,CSACOMP,UR	Curve tolerance:	ISO9906:2012 3B	Motor version:	T40	Specification for shaft end:	SPLINE	Pump:	Stainless steel
Pumped liquid:	Water																								
Max liquid temperature at 0.15 m/sec:	104 °F																								
Selected liquid temperature:	68 °F																								
Density:	62.29 lb/ft <sup>3</sup>																								
Rated flow:	8.81 US gpm																								
Rated head:	173.9 ft																								
Shaft seal for motor:	LIPSEAL																								
Approvals on nameplate:	CE,EAC,CSACOMP,UR																								
Curve tolerance:	ISO9906:2012 3B																								
Motor version:	T40																								
Specification for shaft end:	SPLINE																								
Pump:	Stainless steel																								



Company name:

Created by:

Phone:

Date:

6/23/2020

Count	Description
	EN 1.4301 AISI 304 Impeller: Stainless steel EN 1.4301 AISI 304 Motor: Stainless steel DIN W.-Nr. 1.4301 AISI 304
	<b>Installation:</b> Maximum ambient pressure: 217.56 psi Pump outlet: 1 1/4"NPT Motor diameter: 4 inch
	<b>Electrical data:</b> Motor type: MS402 Type of motor: RSIR Rated power - P2: 0.5 HP Main frequency: 60 Hz Rated voltage: 1 x 115 V Service factor: 1.60 Rated current: 12 A Starting current: 690 % Cos phi - power factor: 0.72 Rated speed: 3450 rpm Start. method: direct-on-line Enclosure class (IEC 34-5): IP68 Insulation class (IEC 85): B Built-in temperature transmitter: No Motor Number: 79922102
	<b>Others:</b> ErP status: EuP Standalone/Prod. Net weight: 24.3 lb Gross weight: 26.9 lb Shipping volume: 352 ft <sup>3</sup> Country of origin: US Custom tariff no.: 8413.70.2004



Company name:  
Created by:  
Phone:

Date: 6/23/2020

### 9019209 10S05-9 60 Hz

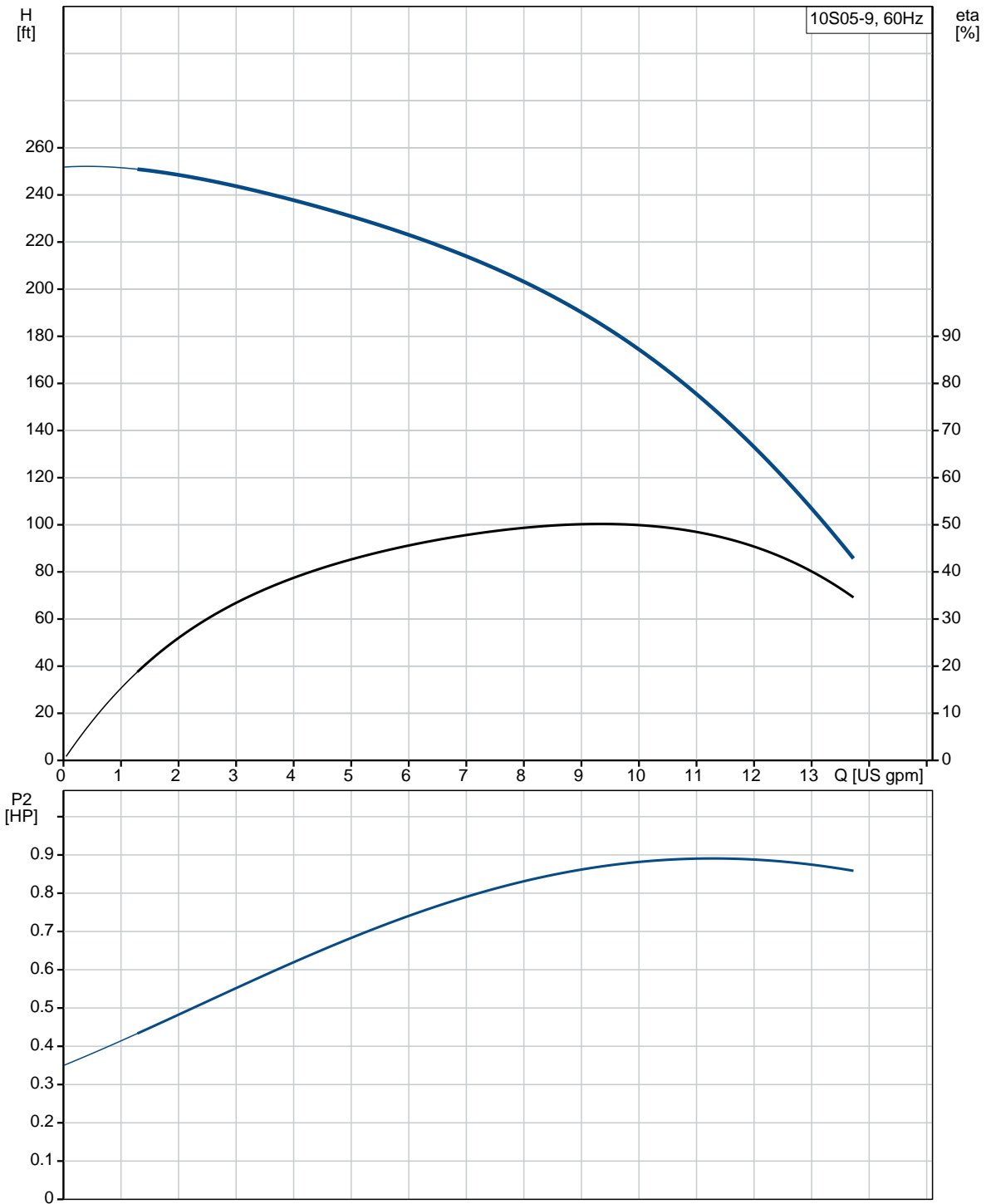



Company name:  
Created by:  
Phone:

Date: 6/23/2020

Description	Value
<b>General information:</b>	
Product name:	10S05-9
Product No.:	9019209
EAN:	5700394419567
	5700394419567
<b>Technical:</b>	
Rated flow:	8.81 US gpm
Rated head:	173.9 ft
Stages:	9
Impeller reduc.:	NONE
Shaft seal for motor:	LIPSEAL
Approvals on nameplate:	CE,EAC,CSACOMP,U R
Curve tolerance:	ISO9906:2012 3B
Pump Number:	09011Z09
Model:	A
Valve:	YES
Motor version:	T40
Specification for shaft end:	SPLINE
<b>Materials:</b>	
Pump:	Stainless steel EN 1.4301 AISI 304
Impeller:	Stainless steel EN 1.4301 AISI 304
Motor:	Stainless steel DIN W.-Nr. 1.4301 AISI 304
<b>Installation:</b>	
Maximum ambient pressure:	217.56 psi
Pump outlet:	1 1/4"NPT
Motor diameter:	4 inch
<b>Liquid:</b>	
Pumped liquid:	Water
Max liquid temperature at 0.15 m/sec:	104 °F
Selected liquid temperature:	68 °F
Density:	62.29 lb/ft <sup>3</sup>
<b>Electrical data:</b>	
Motor type:	MS402
Type of motor:	RSIR
Applic. motor:	GRUNDFOS
Rated power - P2:	0.5 HP
KVA code:	R
Main frequency:	60 Hz
Rated voltage:	1 x 115 V
Service factor:	1.60
Rated current:	12 A

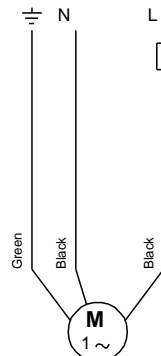
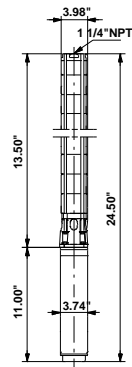
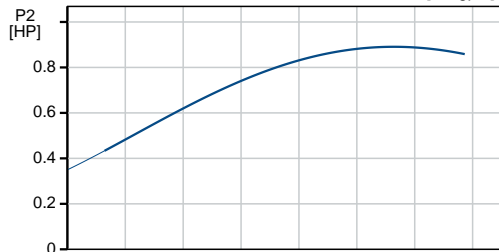
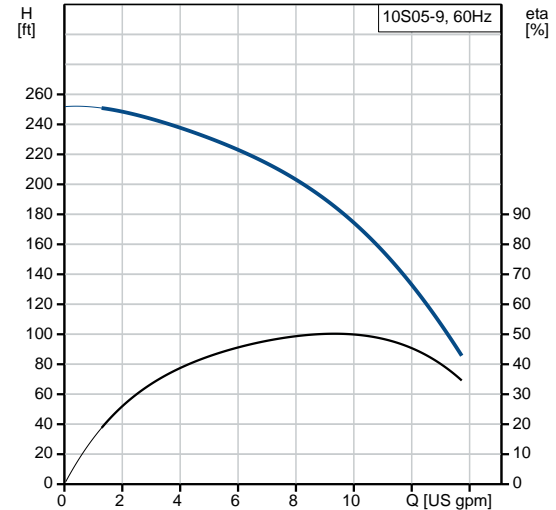



Company name:

Created by:

Phone:

Date:

6/23/2020

Description	Value
Starting current:	690 %
Cos phi - power factor:	0.72
Rated speed:	3450 rpm
Axial load max:	772 lb
Start. method:	direct-on-line
Enclosure class (IEC 34-5):	IP68
Insulation class (IEC 85):	B
Motor protection:	CONTACT
Thermal protec:	internal
Built-in temperature transmitter:	No
Motor Number:	79922102
<b>Others:</b>	
ErP status:	EuP Standalone/Prod.
Net weight:	24.3 lb
Gross weight:	26.9 lb
Shipping volume:	352 ft <sup>3</sup>
Sales region:	Namreg
Country of origin:	US
Custom tariff no.:	8413.70.2004



Company name:  
Created by:  
Phone:

Date: 6/23/2020

**9019209 10S05-9 60 Hz**

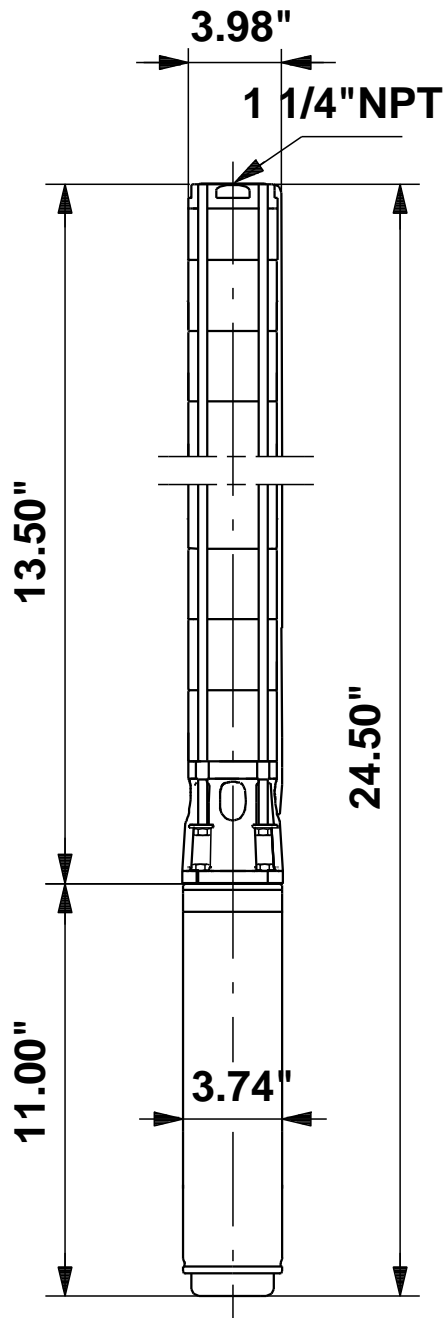

Note! All units are in [in] unless otherwise stated.  
Disclaimer: This simplified dimensional drawing does not show all details.



**9019209 10S05-9 60 Hz**

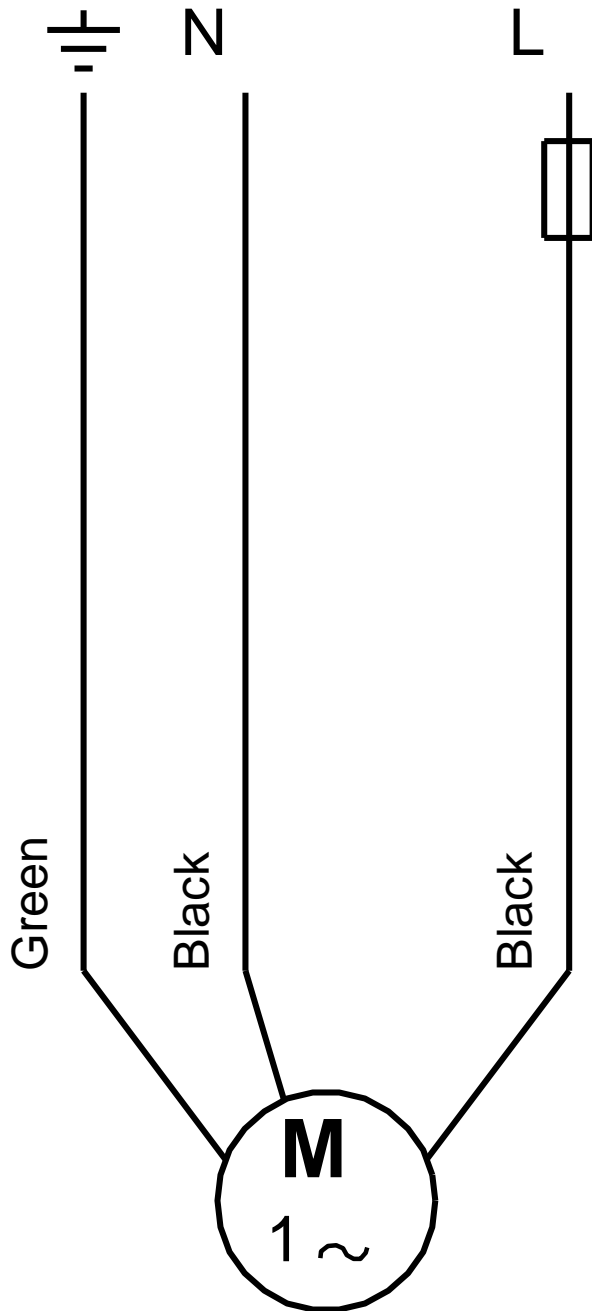

All units are [in] unless otherwise presented.