

PROJECT: _____	UNIT TAG: _____	QUANTITY: _____
REPRESENTATIVE: _____	TYPE OF SERVICE: _____	DATE: _____
ENGINEER: _____	SUBMITTED BY: _____	DATE: _____
CONTRACTOR: _____	APPROVED BY: _____	DATE: _____
	ORDER NO.: _____	DATE: _____



### 10S20-27

Submersible pumps in stainless steel. EN 1.4301 (AISI 304). EN 1.4401 (AISI 316). EN 1.4539 (AISI 904L).  
 Typical application: Ground water, Irrigation, Mining, Fountain, Off-shore etc.

Product photo could vary from the actual product

Conditions of Service	Pump Data	Motor Data
Flow: _____	Approvals: CE,EAC,CSACOMP	Rated power - P2: 2 HP
Head: _____	Product number: 91530275	Rated voltage: 230 V
Efficiency: _____		Main frequency: 60 Hz
Liquid: Water		Enclosure class: IP68
Temperature: 68 °F		Insulation class: B
NPSH required: ft		Motor protection: NONE
Viscosity: _____		Thermal protection: external
Specific Gravity: 1.000		Motor type: MS402

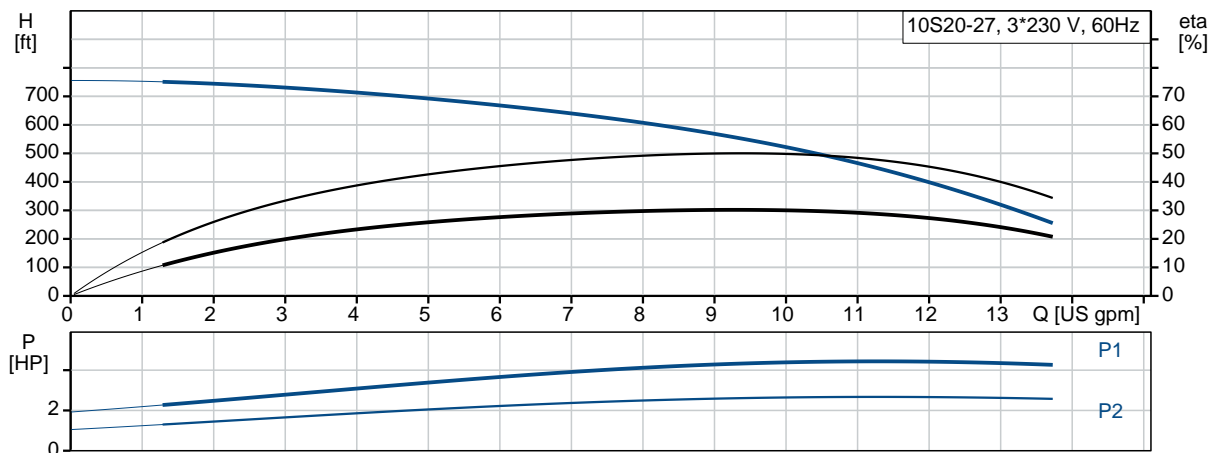

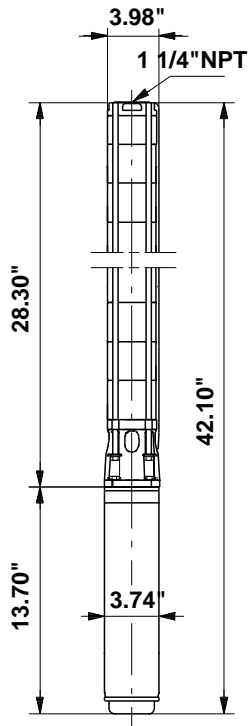

**Materials:**

- Pump: Stainless steel  
EN 1.4301  
AISI 304
- Impeller: Stainless steel  
EN 1.4301  
AISI 304
- Motor: Stainless steel  
DIN W.-Nr. 1.4301  
AISI 304

Count	Description																										
1	<p data-bbox="298 415 407 445"><b>10S20-27</b></p> <div data-bbox="446 457 532 926" style="text-align: center;">  </div> <p data-bbox="686 909 1138 932" style="text-align: center;">Product photo could vary from the actual product</p> <p data-bbox="298 940 561 968">Product No.: <a href="#">91530275</a></p> <p data-bbox="298 972 899 1087">Multi-stage submersible pump for raw water supply, groundwater lowering and pressure boosting. The pump is suitable for pumping clean, thin, non-aggressive liquids without solid particles or fibers.</p> <p data-bbox="298 1119 834 1234">The pump is made entirely of Stainless steel DIN W.-Nr. EN 1.4301 and suitable for horizontal and vertical installation. The pump is fitted with a built-in non-return valve.</p> <p data-bbox="298 1266 834 1354">The motor is a 3-phase motor of the canned type with a sand shield, liquid-lubricated bearings and pressure-equalizing diaphragm.</p> <p data-bbox="298 1383 383 1411"><b>Liquid:</b></p> <table data-bbox="298 1415 805 1560"> <tr> <td>Pumped liquid:</td> <td>Water</td> </tr> <tr> <td>Maximum liquid temperature:</td> <td>140 °F</td> </tr> <tr> <td>Max liquid temperature at 0.15 m/sec:</td> <td>104 °F</td> </tr> <tr> <td>Selected liquid temperature:</td> <td>68 °F</td> </tr> <tr> <td>Density:</td> <td>62.29 lb/ft<sup>3</sup></td> </tr> </table> <p data-bbox="298 1591 423 1619"><b>Technical:</b></p> <table data-bbox="298 1623 894 1856"> <tr> <td>Pump speed on which pump data is based:</td> <td>3450 rpm</td> </tr> <tr> <td>Rated flow:</td> <td>8.81 US gpm</td> </tr> <tr> <td>Rated head:</td> <td>518.4 ft</td> </tr> <tr> <td>Shaft seal for motor:</td> <td>LIPSEAL</td> </tr> <tr> <td>Approvals on nameplate:</td> <td>CE,EAC,CSACOMP</td> </tr> <tr> <td>Curve tolerance:</td> <td>ISO9906:2012 3B</td> </tr> <tr> <td>Motor version:</td> <td>T40</td> </tr> <tr> <td>Specification for shaft end:</td> <td>SPLINE</td> </tr> </table>	Pumped liquid:	Water	Maximum liquid temperature:	140 °F	Max liquid temperature at 0.15 m/sec:	104 °F	Selected liquid temperature:	68 °F	Density:	62.29 lb/ft <sup>3</sup>	Pump speed on which pump data is based:	3450 rpm	Rated flow:	8.81 US gpm	Rated head:	518.4 ft	Shaft seal for motor:	LIPSEAL	Approvals on nameplate:	CE,EAC,CSACOMP	Curve tolerance:	ISO9906:2012 3B	Motor version:	T40	Specification for shaft end:	SPLINE
Pumped liquid:	Water																										
Maximum liquid temperature:	140 °F																										
Max liquid temperature at 0.15 m/sec:	104 °F																										
Selected liquid temperature:	68 °F																										
Density:	62.29 lb/ft <sup>3</sup>																										
Pump speed on which pump data is based:	3450 rpm																										
Rated flow:	8.81 US gpm																										
Rated head:	518.4 ft																										
Shaft seal for motor:	LIPSEAL																										
Approvals on nameplate:	CE,EAC,CSACOMP																										
Curve tolerance:	ISO9906:2012 3B																										
Motor version:	T40																										
Specification for shaft end:	SPLINE																										



Company name:

Created by:

Phone:

Date:

7/1/2020

Count	Description
	<b>Materials:</b>
	Pump: Stainless steel EN 1.4301 AISI 304
	Impeller: Stainless steel EN 1.4301 AISI 304
	Motor: Stainless steel DIN W.-Nr. 1.4301 AISI 304
	<b>Installation:</b>
	Maximum ambient pressure: 217.56 psi
	Pump outlet: 1 1/4"NPT
	Motor diameter: 4 inch
	<b>Electrical data:</b>
	Motor type: MS402
	Rated power - P2: 2 HP
	Power (P2) required by pump: 2 HP
	Main frequency: 60 Hz
	Rated voltage: 3 x 230 V
	Service factor: 1.25
	Rated current: 8.7 A
	Starting current: 540 %
	Cos phi - power factor: 0.75
	Rated speed: 3450 rpm
	Start. method: direct-on-line
	Enclosure class (IEC 34-5): IP68
	Insulation class (IEC 85): B
	Built-in temperature transmitter: No
	Motor Number: 79302006
	<b>Others:</b>
	ErP status: EuP Standalone/Prod.
	Net weight: 44.1 lb
	Gross weight: 49 lb
	Shipping volume: 352 ft <sup>3</sup>
	Country of origin: US
	Custom tariff no.: 8413.70.2004



Company name:  
Created by:  
Phone:

Date: 7/1/2020

### 91530275 10S20-27 60 Hz

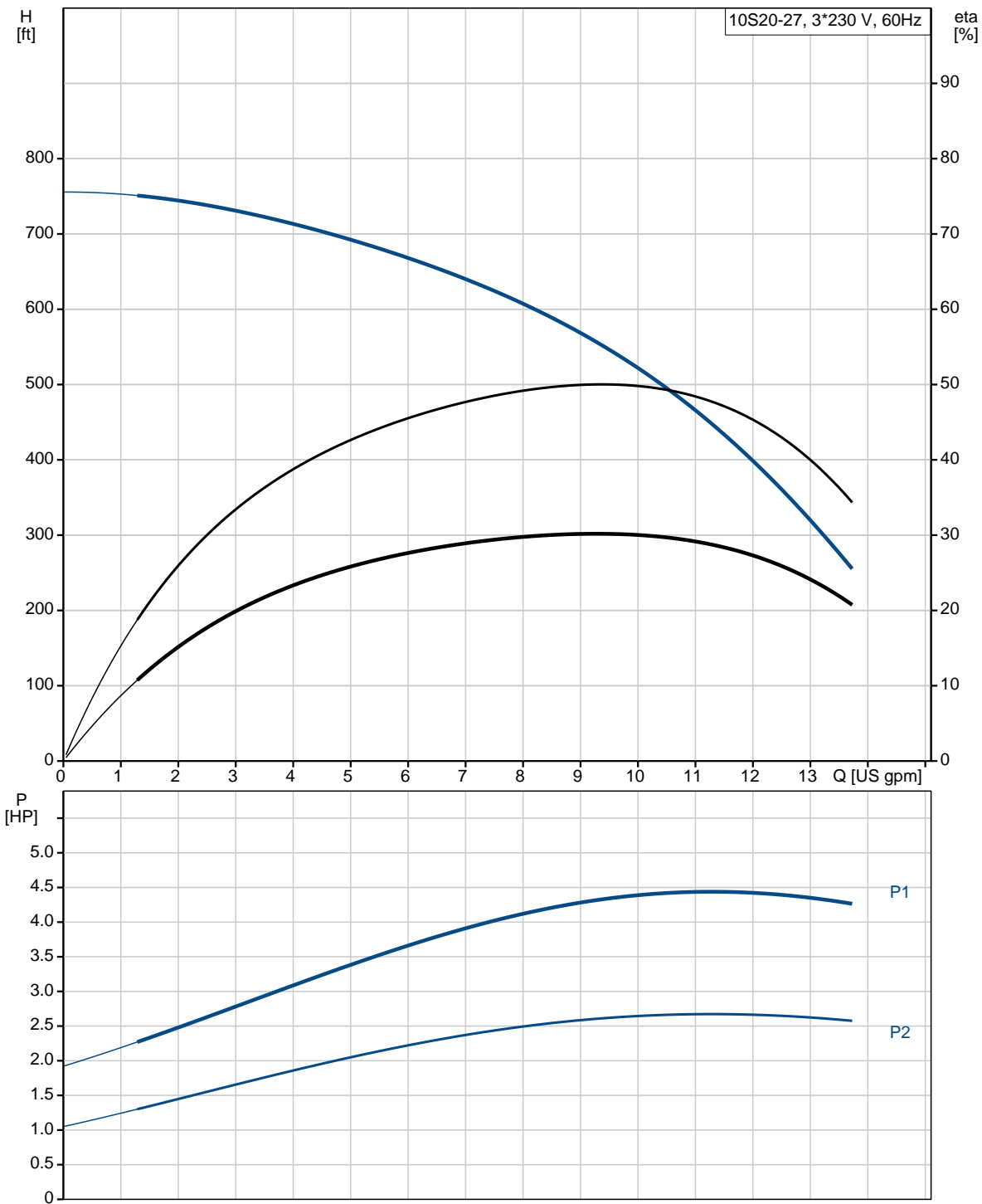



Company name:  
Created by:  
Phone:

Date: 7/1/2020

Description	Value
<b>General information:</b>	
Product name:	10S20-27
Product No.:	91530275
EAN:	5700394510691
	5700394510691
<b>Technical:</b>	
Pump speed on which pump data is based:	3450 rpm
Rated flow:	8.81 US gpm
Rated head:	518.4 ft
Stages:	27
Impeller reduc.:	NONE
Shaft seal for motor:	LIPSEAL
Approvals on nameplate:	CE,EAC,CSACOMP
Curve tolerance:	ISO9906:2012 3B
Pump Number:	09010027
Model:	A
Valve:	YES
Motor version:	T40
Specification for shaft end:	SPLINE
<b>Materials:</b>	
Pump:	Stainless steel
	EN 1.4301
	AISI 304
Impeller:	Stainless steel
	EN 1.4301
	AISI 304
Motor:	Stainless steel
	DIN W.-Nr. 1.4301
	AISI 304
<b>Installation:</b>	
Maximum ambient pressure:	217.56 psi
Pump outlet:	1 1/4"NPT
Motor diameter:	4 inch
<b>Liquid:</b>	
Pumped liquid:	Water
Maximum liquid temperature:	140 °F
Max liquid temperature at 0.15 m/sec:	104 °F
Selected liquid temperature:	68 °F
Density:	62.29 lb/ft <sup>3</sup>
<b>Electrical data:</b>	
Motor type:	MS402
Applic. motor:	GRUNDFOS
Rated power - P2:	2 HP
Power (P2) required by pump:	2 HP
KVA code:	L
Main frequency:	60 Hz
Rated voltage:	3 x 230 V
Service factor:	1.25

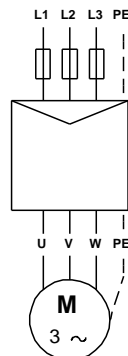
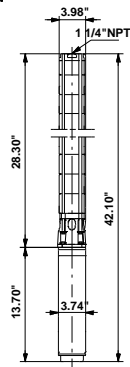
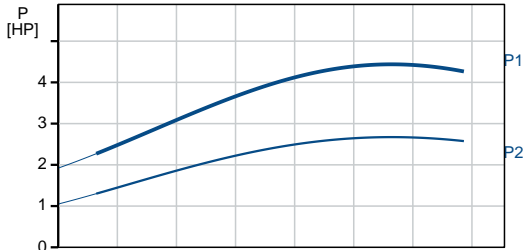
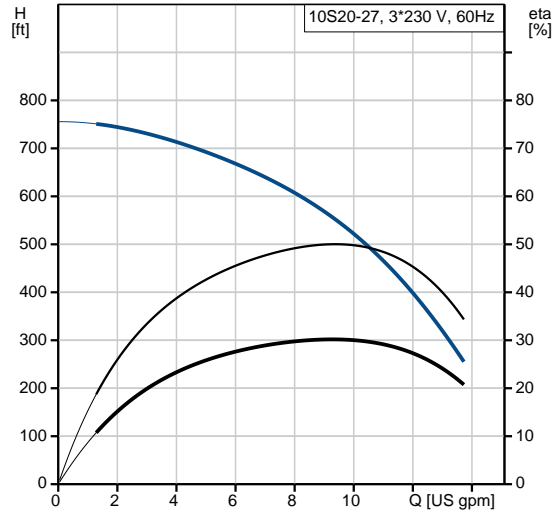



Company name:

Created by:

Phone:

Date:

7/1/2020

Description	Value
Rated current:	8.7 A
Starting current:	540 %
Cos phi - power factor:	0.75
Rated speed:	3450 rpm
Axial load max:	772 lb
Start. method:	direct-on-line
Enclosure class (IEC 34-5):	IP68
Insulation class (IEC 85):	B
Motor protection:	NONE
Thermal protec:	external
Built-in temperature transmitter:	No
Motor Number:	79302006
<b>Others:</b>	
ErP status:	EuP Standalone/Prod.
Net weight:	44.1 lb
Gross weight:	49 lb
Shipping volume:	352 ft <sup>3</sup>
Sales region:	Namreg
Country of origin:	US
Custom tariff no.:	8413.70.2004



Company name:  
Created by:  
Phone:

Date: 7/1/2020

### 91530275 10S20-27 60 Hz

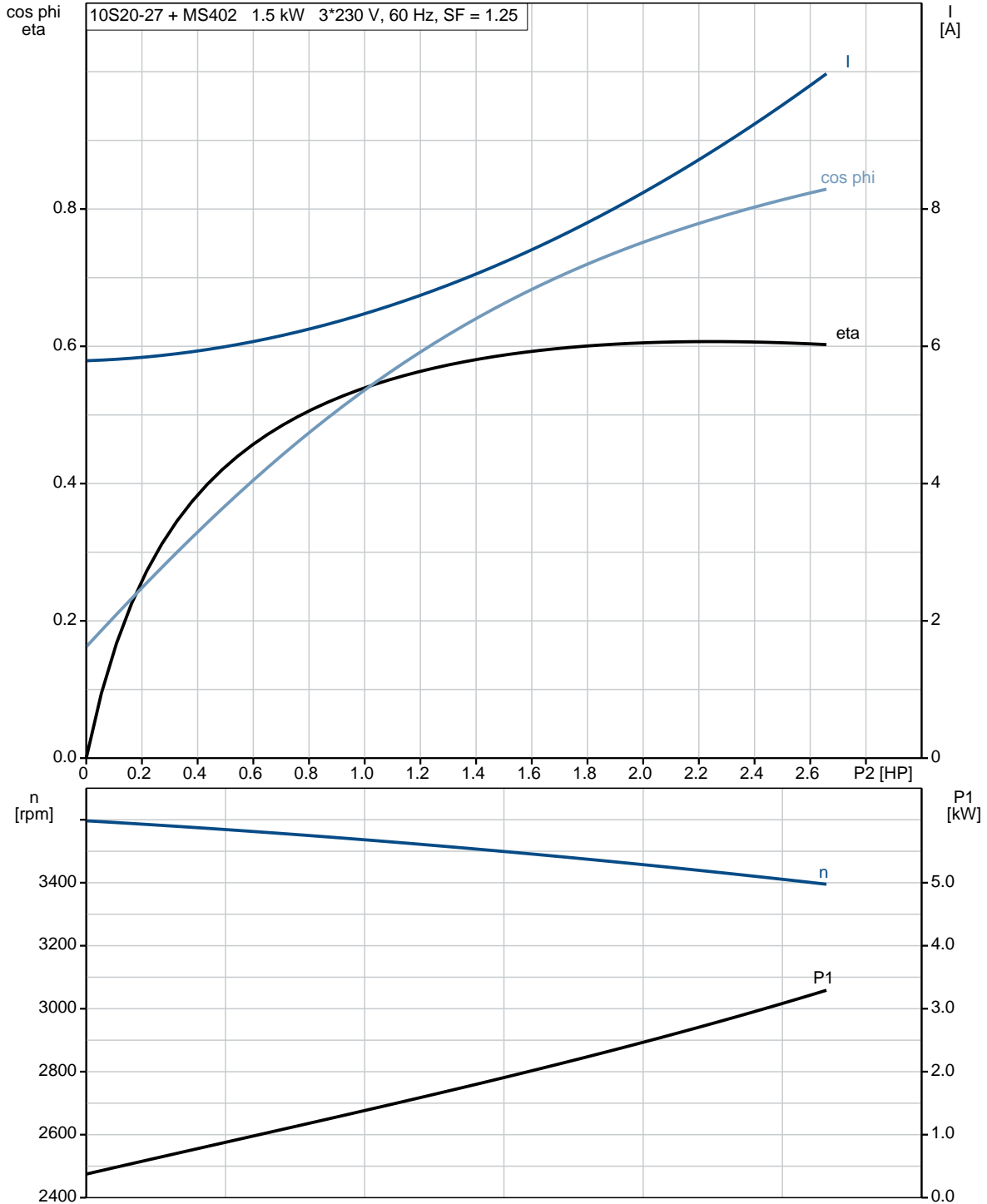





Company name:  
Created by:  
Phone:

Date: 7/1/2020

**91530275 10S20-27 60 Hz**

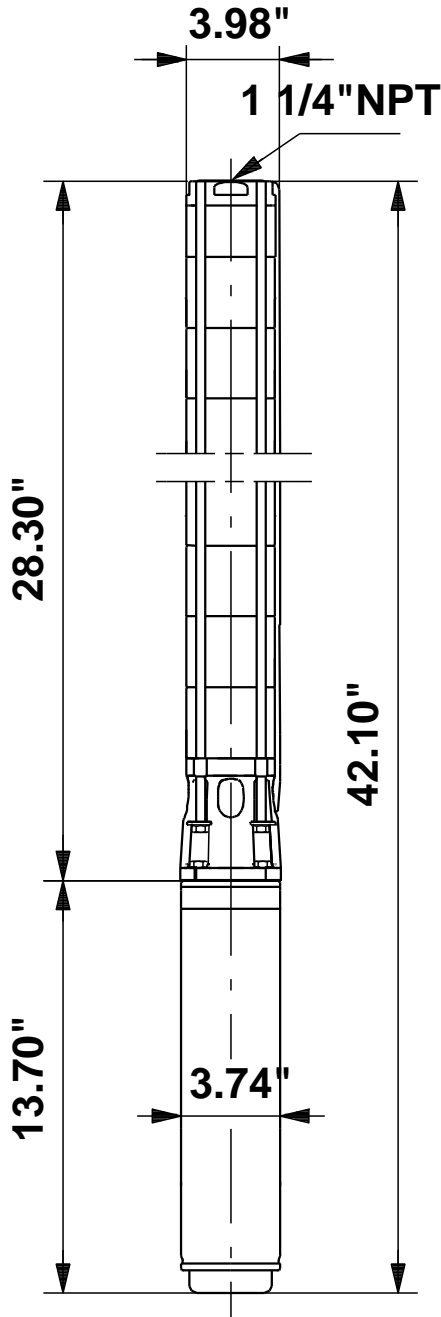

Note! All units are in [in] unless otherwise stated.  
Disclaimer: This simplified dimensional drawing does not show all details.

**91530275 10S20-27 60 Hz**

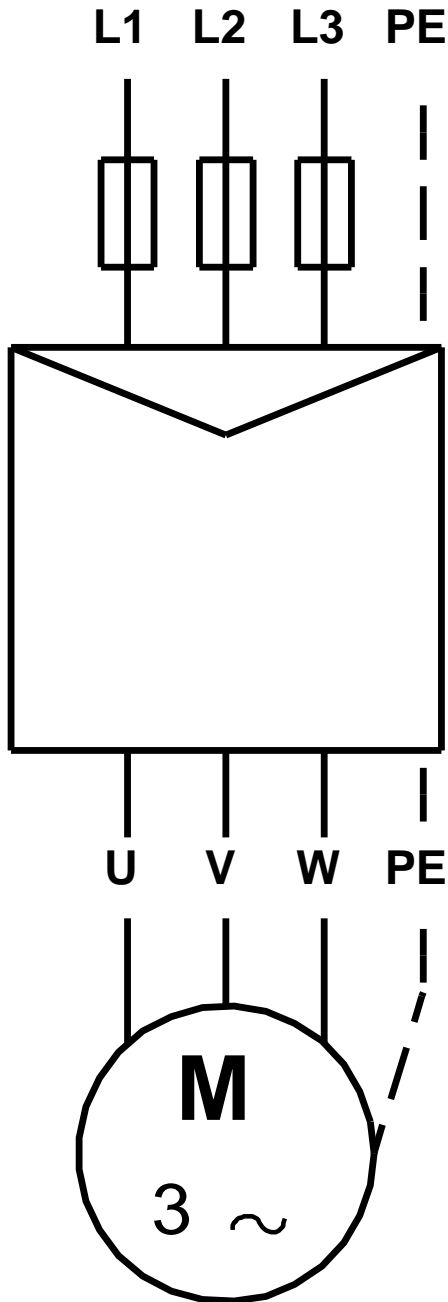

All units are [in] unless otherwise presented.