

PROJECT: _____	UNIT TAG: _____	QUANTITY: _____
REPRESENTATIVE: _____	TYPE OF SERVICE: _____	DATE: _____
ENGINEER: _____	SUBMITTED BY: _____	DATE: _____
CONTRACTOR: _____	APPROVED BY: _____	DATE: _____
	ORDER NO.: _____	DATE: _____



10S50-58

Submersible pumps in stainless steel. EN 1.4301 (AISI 304). EN 1.4401 (AISI 316). EN 1.4539 (AISI 904L).
 Typical application: Ground water, Irrigation, Mining, Fountain, Off-shore etc.

Product photo could vary from the actual product

Conditions of Service	Pump Data	Motor Data
Flow: _____	Approvals: CE, GOST2, CSA	Rated power - P2: 5 HP
Head: _____	Product number: 91530585	Rated voltage: 208-230 V
Efficiency: _____		Main frequency: 60 Hz
Liquid: Water		Enclosure class: IP58
Temperature: 68 °F		Insulation class: F
NPSH required: ft		Motor protection: NONE
Viscosity: _____		Thermal protection: external
Specific Gravity: 1.000		Motor type: MS4000

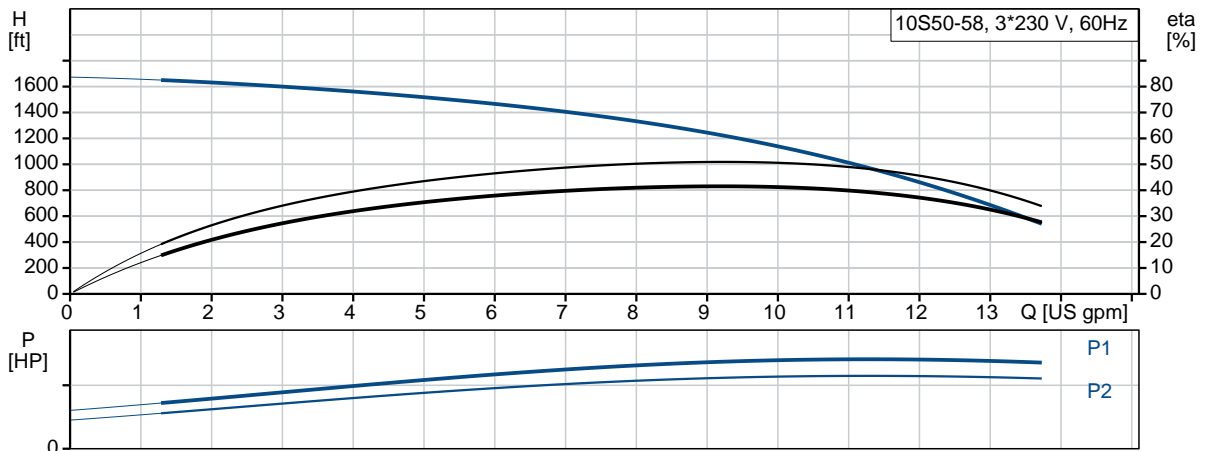

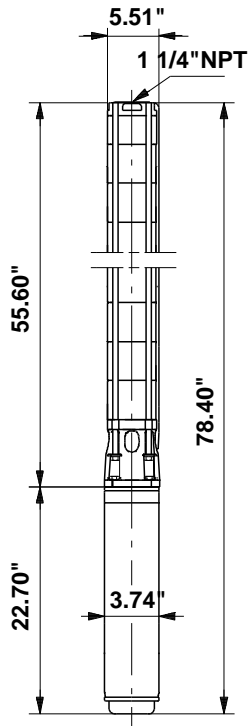

Materials:

- Pump: Stainless steel
EN 1.4301
AISI 304
- Impeller: Stainless steel
EN 1.4301
AISI 304
- Motor: Stainless steel
DIN W.-Nr. 1.4301
AISI 304

Count	Description																								
1	<p data-bbox="298 415 407 443">10S50-58</p> <div data-bbox="472 449 500 930" style="text-align: center;">  </div> <p data-bbox="685 909 1138 932" style="text-align: center;">Product photo could vary from the actual product</p> <p data-bbox="298 940 561 968">Product No.: 91530585</p> <p data-bbox="298 972 899 1087">Multi-stage submersible pump for raw water supply, groundwater lowering and pressure boosting. The pump is suitable for pumping clean, thin, non-aggressive liquids without solid particles or fibers.</p> <p data-bbox="298 1119 834 1234">The pump is made entirely of Stainless steel DIN W.-Nr. EN 1.4301 and suitable for horizontal and vertical installation. The pump is fitted with a built-in non-return valve.</p> <p data-bbox="298 1266 834 1354">The motor is a 3-phase motor of the canned type with a sand shield, liquid-lubricated bearings and pressure-equalizing diaphragm.</p> <p data-bbox="298 1383 383 1411">Liquid:</p> <table data-bbox="298 1415 776 1533"> <tr> <td>Pumped liquid:</td> <td>Water</td> </tr> <tr> <td>Maximum liquid temperature:</td> <td>140 °F</td> </tr> <tr> <td>Selected liquid temperature:</td> <td>68 °F</td> </tr> <tr> <td>Density:</td> <td>62.29 lb/ft³</td> </tr> </table> <p data-bbox="298 1562 423 1589">Technical:</p> <table data-bbox="298 1593 893 1797"> <tr> <td>Pump speed on which pump data is based:</td> <td>3450 rpm</td> </tr> <tr> <td>Rated flow:</td> <td>8.81 US gpm</td> </tr> <tr> <td>Rated head:</td> <td>1112 ft</td> </tr> <tr> <td>Shaft seal for motor:</td> <td>HM/CER</td> </tr> <tr> <td>Approvals on nameplate:</td> <td>CE,GOST2,CSA</td> </tr> <tr> <td>Curve tolerance:</td> <td>ISO9906:2012 3B</td> </tr> <tr> <td>Specification for shaft end:</td> <td>CYLINDRICAL</td> </tr> </table> <p data-bbox="298 1827 415 1854">Materials:</p> <table data-bbox="298 1858 818 1885"> <tr> <td>Pump:</td> <td>Stainless steel</td> </tr> </table>	Pumped liquid:	Water	Maximum liquid temperature:	140 °F	Selected liquid temperature:	68 °F	Density:	62.29 lb/ft ³	Pump speed on which pump data is based:	3450 rpm	Rated flow:	8.81 US gpm	Rated head:	1112 ft	Shaft seal for motor:	HM/CER	Approvals on nameplate:	CE,GOST2,CSA	Curve tolerance:	ISO9906:2012 3B	Specification for shaft end:	CYLINDRICAL	Pump:	Stainless steel
Pumped liquid:	Water																								
Maximum liquid temperature:	140 °F																								
Selected liquid temperature:	68 °F																								
Density:	62.29 lb/ft ³																								
Pump speed on which pump data is based:	3450 rpm																								
Rated flow:	8.81 US gpm																								
Rated head:	1112 ft																								
Shaft seal for motor:	HM/CER																								
Approvals on nameplate:	CE,GOST2,CSA																								
Curve tolerance:	ISO9906:2012 3B																								
Specification for shaft end:	CYLINDRICAL																								
Pump:	Stainless steel																								



Company name:

Created by:

Phone:

Date:

7/8/2020

Count	Description
	EN 1.4301 AISI 304 Impeller: Stainless steel EN 1.4301 AISI 304 Motor: Stainless steel DIN W.-Nr. 1.4301 AISI 304
	Installation: Maximum ambient pressure: 870.23 psi Pump outlet: 1 1/4"NPT Motor diameter: 4 inch
	Electrical data: Motor type: MS4000 Rated power - P2: 5 HP Power (P2) required by pump: 5.5 HP Main frequency: 60 Hz Rated voltage: 3 x 208-230 V Service factor: 1.15 Rated current: 18.6-17.4 A Starting current: 490-590 % Cos phi - power factor: 0.87-0.78 Rated speed: 3425-3470 rpm Start. method: direct-on-line Enclosure class (IEC 34-5): IP58 Insulation class (IEC 85): F Built-in temperature transmitter: No Motor Number: 79304509
	Others: ErP status: EuP Standalone/Prod. Net weight: 132 lb Gross weight: 147 lb Shipping volume: 9810 ft ³ Country of origin: US Custom tariff no.: 8413.70.2004



Company name:
Created by:
Phone:

Date: 7/8/2020

91530585 10S50-58 60 Hz

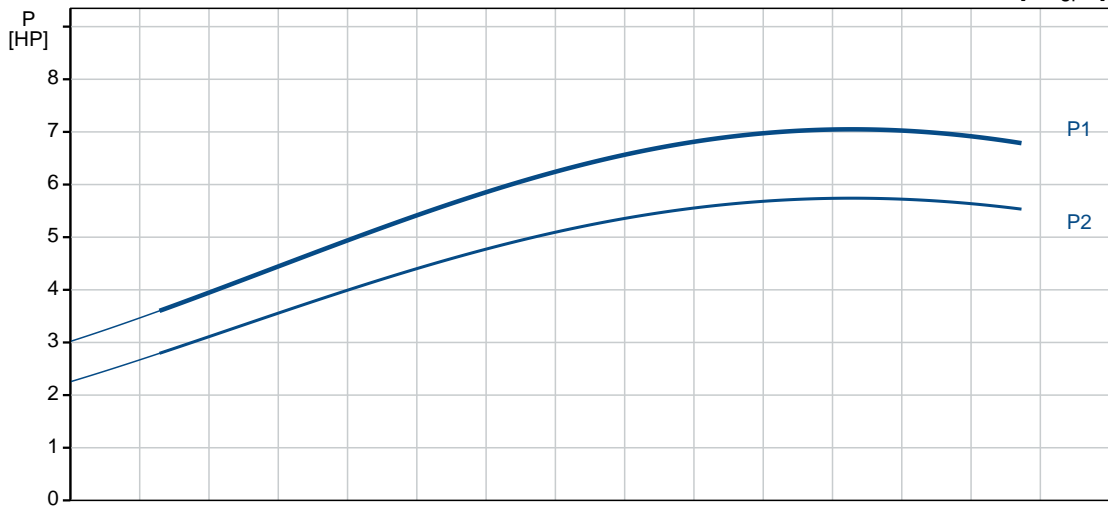
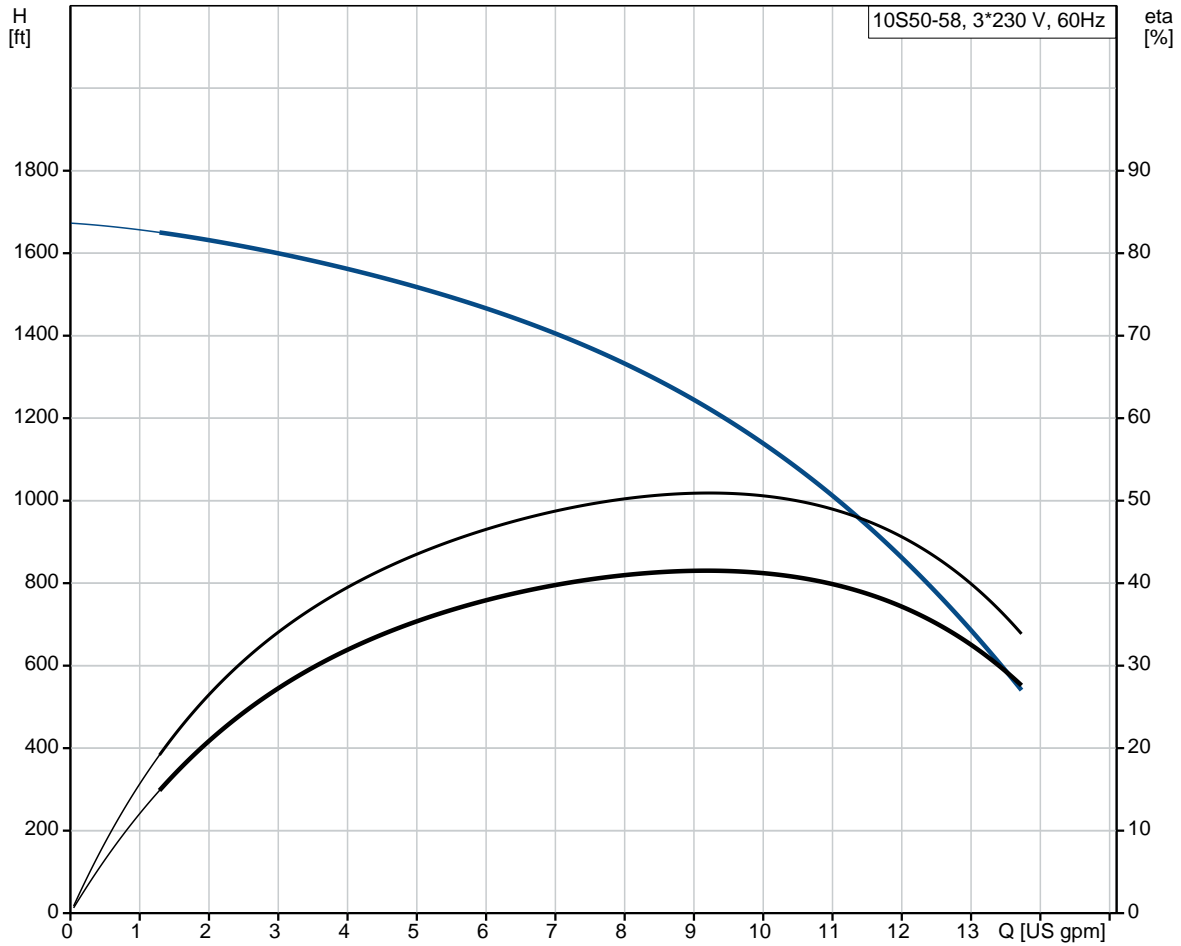



Company name:
Created by:
Phone:

Date: 7/8/2020

Description	Value
General information:	
Product name:	10S50-58
Product No.:	91530585
EAN:	5700394510721
	5700394510721
Technical:	
Pump speed on which pump data is based:	3450 rpm
Rated flow:	8.81 US gpm
Rated head:	1112 ft
Stages:	58
Impeller reduc.:	NONE
Shaft seal for motor:	HM/CER
Approvals on nameplate:	CE,GOST2,CSA
Curve tolerance:	ISO9906:2012 3B
Pump Number:	09310058
Model:	A
Valve:	YES
Specification for shaft end:	CYLINDRICAL
Materials:	
Pump:	Stainless steel EN 1.4301 AISI 304
Impeller:	Stainless steel EN 1.4301 AISI 304
Motor:	Stainless steel DIN W.-Nr. 1.4301 AISI 304
Installation:	
Maximum ambient pressure:	870.23 psi
Pump outlet:	1 1/4"NPT
Motor diameter:	4 inch
Liquid:	
Pumped liquid:	Water
Maximum liquid temperature:	140 °F
Selected liquid temperature:	68 °F
Density:	62.29 lb/ft³
Electrical data:	
Motor type:	MS4000
Applic. motor:	GRUNDFOS
Rated power - P2:	5 HP
Power (P2) required by pump:	5.5 HP
Main frequency:	60 Hz
Rated voltage:	3 x 208-230 V
Service factor:	1.15
Rated current:	18.6-17.4 A
Starting current:	490-590 %
Cos phi - power factor:	0.87-0.78

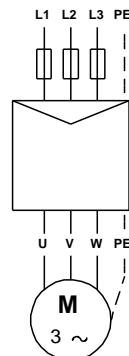
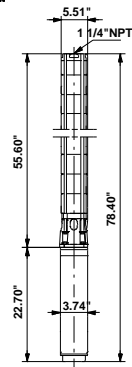
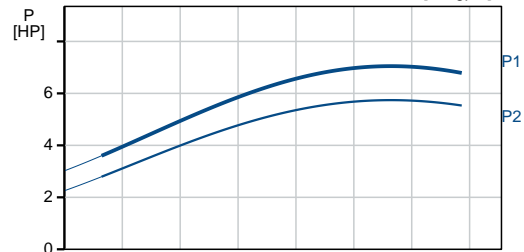
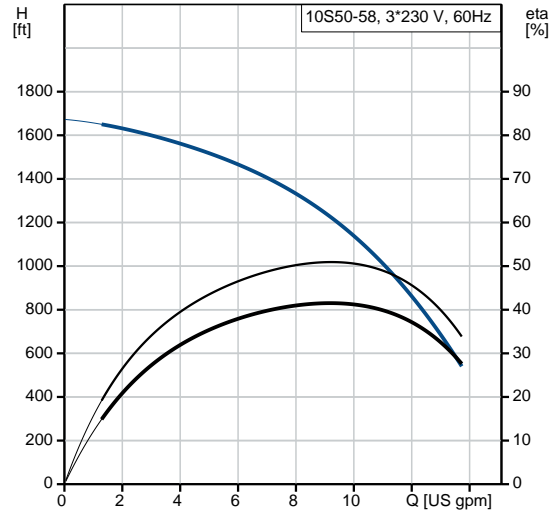



Company name:

Created by:

Phone:

Date:

7/8/2020

Description	Value
Rated speed:	3425-3470 rpm
Axial load max:	992 lb
Start. method:	direct-on-line
Enclosure class (IEC 34-5):	IP58
Insulation class (IEC 85):	F
Motor protection:	NONE
Thermal protec:	external
Built-in temperature transmitter:	No
Motor Number:	79304509
Others:	
ErP status:	EuP Standalone/Prod.
Net weight:	132 lb
Gross weight:	147 lb
Shipping volume:	9810 ft ³
Sales region:	Namreg
Country of origin:	US
Custom tariff no.:	8413.70.2004



Company name:
Created by:
Phone:

Date: 7/8/2020

91530585 10S50-58 60 Hz

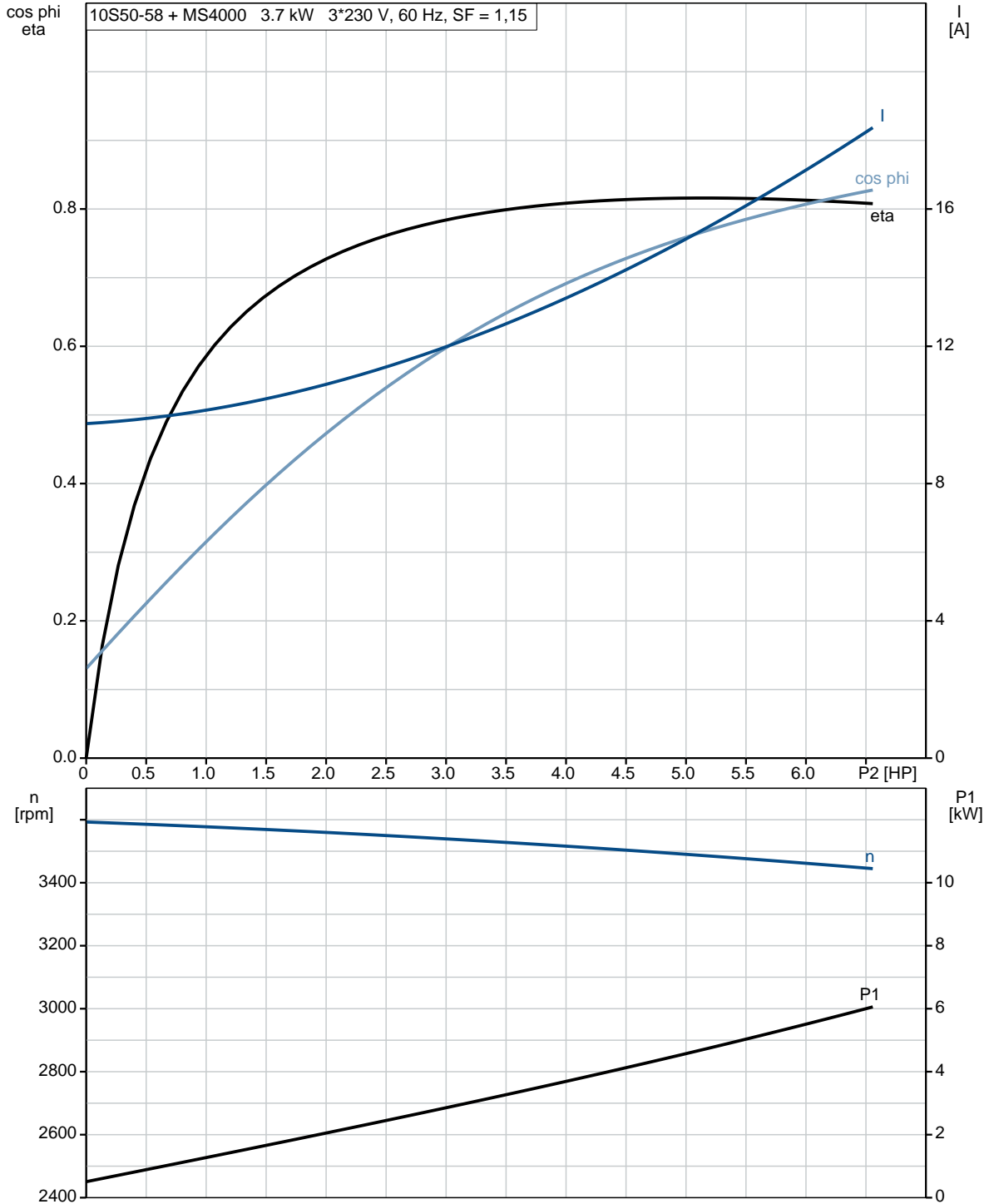



Company name:
Created by:
Phone:

Date: 7/8/2020

91530585 10S50-58 60 Hz

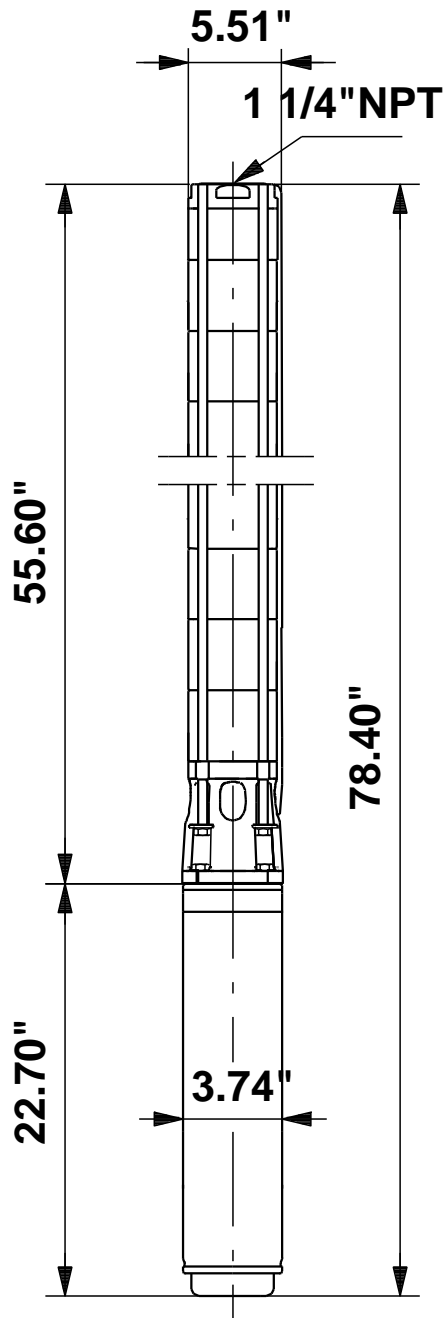

Note! All units are in [in] unless otherwise stated.
Disclaimer: This simplified dimensional drawing does not show all details.

91530585 10S50-58 60 Hz

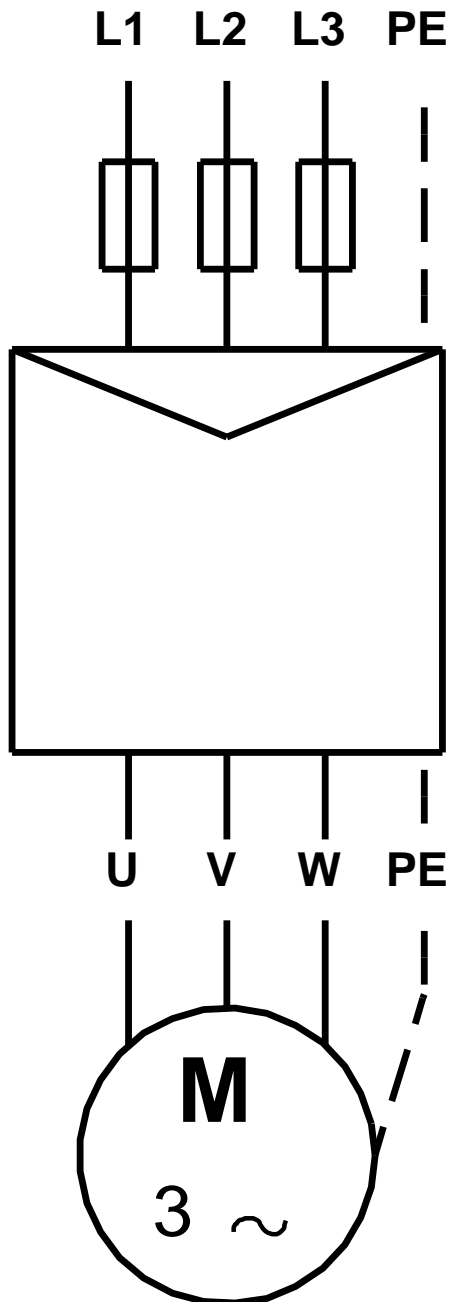

All units are [in] unless otherwise presented.