



Customer	Date	11.02.2021
Contact	Project	
Phone number	Project no.	
Email		

22HM02N40T6PBQE

Operating data

Pump type	Single head pump	Fluid	Water
No. of pumps / Reserve	1 / 0	Operating temperature t A	°F 39.2
Nominal flow	US g.p.m. 0	pH-value at t A	7
Nominal head	ft 0	Density at t A	lb/ft ³ 62.4
Static head	ft 0	Kin. viscosity at t A	ft ² /s 1.689E-5
Inlet pressure	psi 0	Vapor pressure at t A	psi 14.5
Environmental temperature	°F 68	Solids	0
Available system NPSH	ft 0	Altitude	ft 0

Pump data

Make	Goulds	Nominal	US g.p.m. ()
Speed	rpm 3500	Flow	Max- US g.p.m. 149.8
No. of stages	2		Min- US g.p.m.
Max. casing pressure	psi	Nominal	ft
Max. working pressure	psi 62.4	Head	at Qmax ft 59.2
Head H(Q=0)	ft 140		at Qmin ft 144
Weight	lb 71	Shaft power	hp ()
		Max. shaft power	hp 1.6
		Efficiency	%
		NPSH 3%	ft

Pump Materials

Adapter	Aluminium
Diffuser	Stainless steel
Fill / drain plugs	Stainless steel
Head	Stainless steel
Impeller	Stainless steel 316
Outer sleeve	Stainless steel
Ring with foot	Aluminium
Seal Housing	Stainless steel
Shaft	Stainless steel
Shaft sleeve and bushing	Tungsten carbide
Tie rods	Stainless steel
Wear Ring	Technopolymer (PPS)

Shaft Seal

Rotating Part	Silicon Carbide
Stationary Part	Carbon, resin-impregnated
Elastomers	EPDM
Springs	AISI 316
Other Components	AISI 316

Motor data

Specific design	IE3 Three phase surface motor		
Type	PLM100HM..A/UL340 E3		
Rated power	5.5 hp	Electric voltage	208 V
Speed	3520 rpm	Electric current	14.1 A
Frame size	56	Degree of protection	55
Colour	RAL 5010	Insulation class	155 (F)



Customer	
Contact	11.02.2021
Phone number	
Email	
Date	11.02.2021
Project	
Project no.	

22HM02N40T6PBQE

Hydraulic Data

Operating Data Specification		Hydraulic data (duty point)		Impeller design	
Flow	0 US g.p.m.	Flow		Impeller R	4 1/4 inch
Head	0 ft	Head		Frequency	60 Hz
Static head	0 ft			Speed	3500 rpm

Power data referred to:
 Water [100%] ; 39.2°F; 62.4lb/ft³; 1.69E-5ft²/s
 Performance according to ANSI/HI 14.6 - Grade 2B

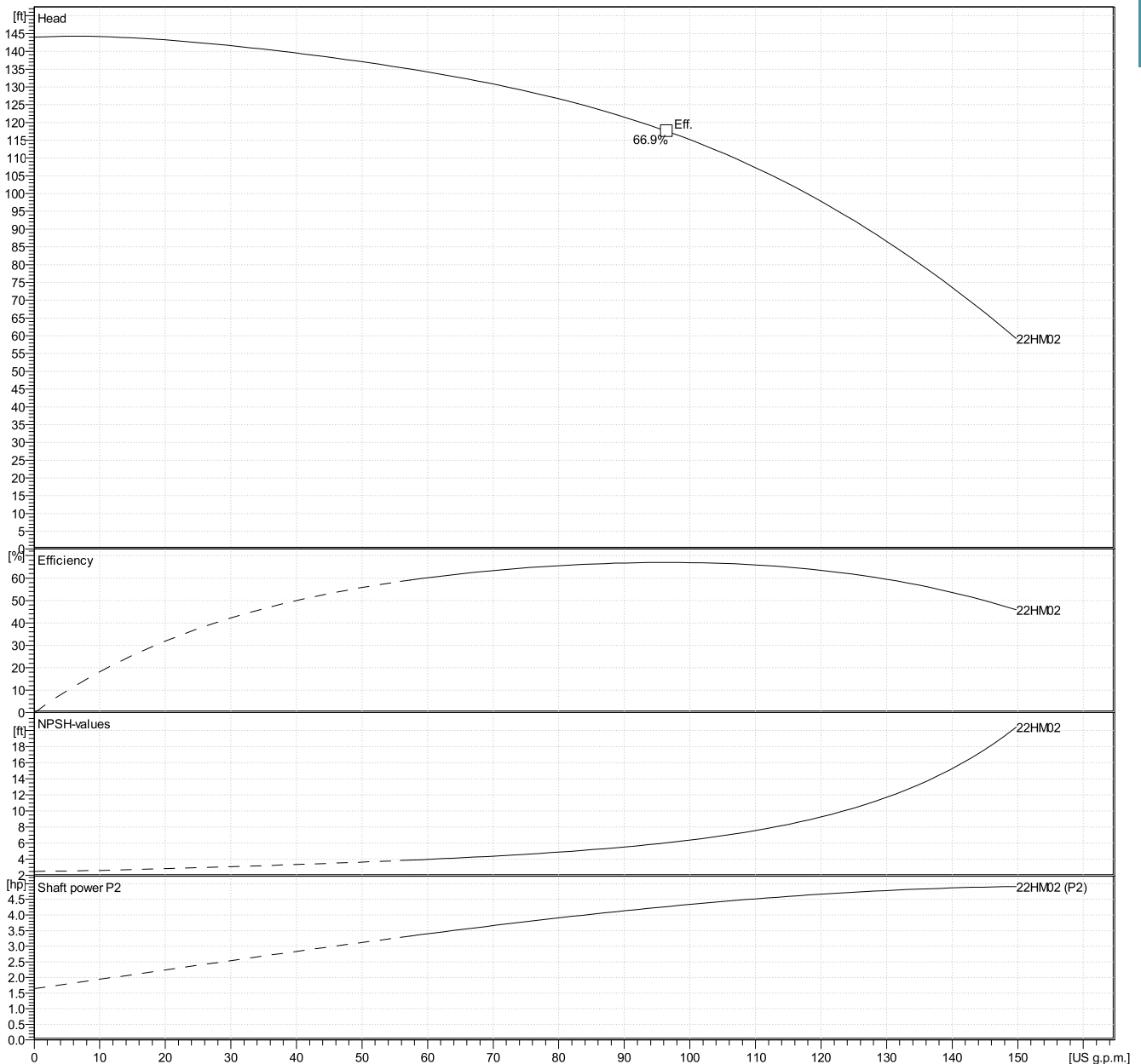



Customer	Date	11.02.2021
Contact	Project	
Phone number	Project no.	
Email		

22HM02N40T6PBQE

Drawing

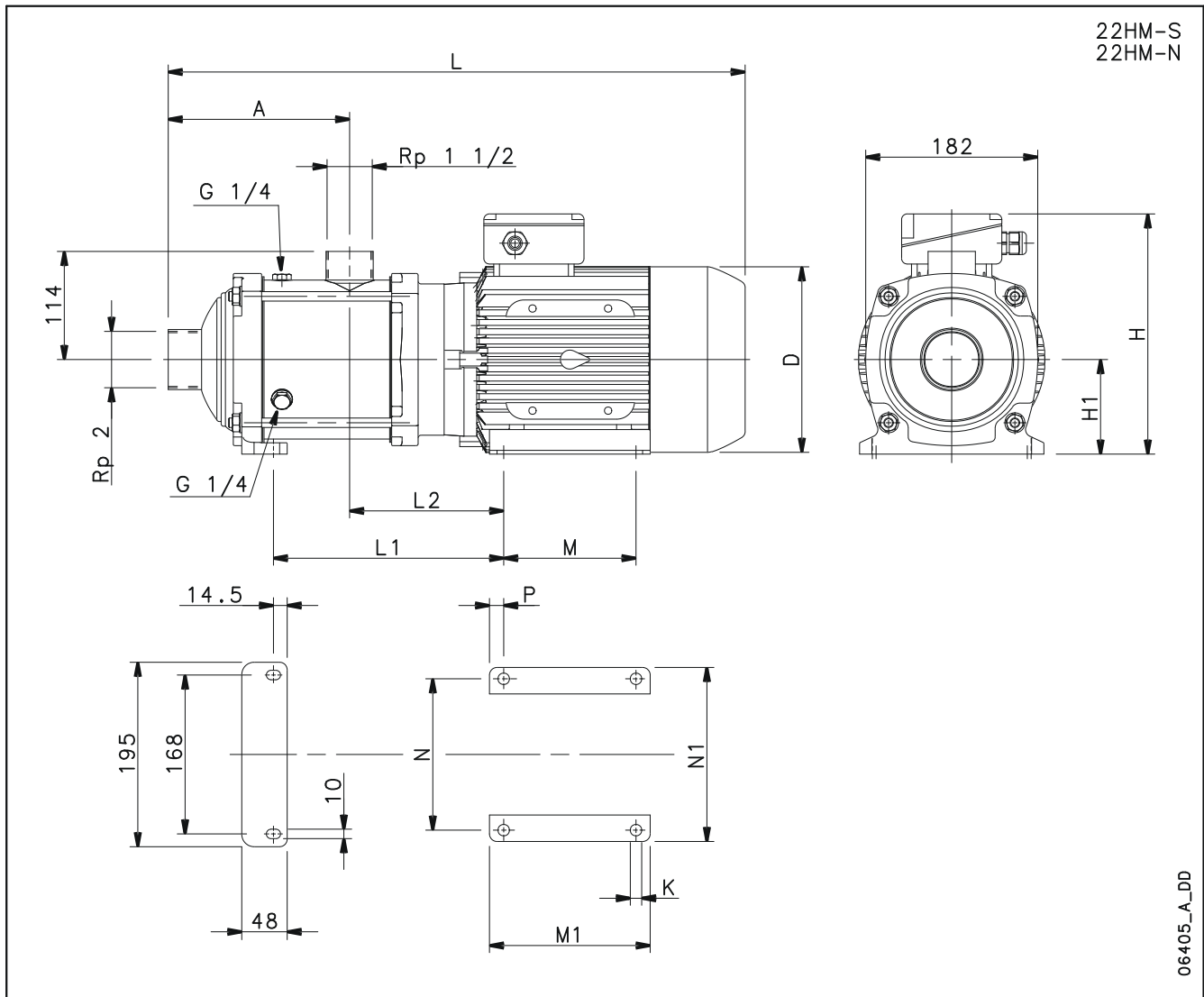

06405_A_DD

Dimensions inch

A	$5\frac{11}{16}$	M1	$6\frac{11}{16}$		Weight 70.547 lb
D	$7\frac{3}{4}$	N	$6\frac{5}{16}$		
H	10	N-1	$7\frac{1}{4}$		
H1	$3\frac{15}{16}$	P	$9\frac{9}{16}$		
K	$\frac{1}{2}$				
L	$22\frac{3}{16}$				
L1	$7\frac{11}{16}$				
L2	$6\frac{7}{16}$				
M	$5\frac{1}{2}$				