

PROJECT: _____	UNIT TAG: _____	QUANTITY: _____
REPRESENTATIVE: _____	TYPE OF SERVICE: _____	DATE: _____
ENGINEER: _____	SUBMITTED BY: _____	DATE: _____
CONTRACTOR: _____	APPROVED BY: _____	DATE: _____
	ORDER NO.: _____	DATE: _____



Product photo could vary from the actual product

**CR 20-3 A-GJ-A-V-HQQV**

Vertical, multistage centrifugal pump with suction and discharge ports on the same level. The pump head and base are in cast iron. All other wetted parts are in stainless steel (EN 1.4301)(AISI 304)

Conditions of Service	Pump Data	Motor Data
Efficiency: _____	Max pressure at stated temperature: 232 psi / 194 °F	Rated power - P2: 7.5 HP
Liquid: Water	Liquid temperature range: -4 .. 194 °F	Rated voltage: 208-230/460 V
Temperature: 68 °F	Maximum ambient temperature: 104 °F	Main frequency: 60 Hz
NPSH required: ft	Shaft seal: HQQV	Enclosure class: IP55
Specific Gravity: 1.000	Product number: 99917756	Insulation class: F
		Motor protection: NONE
		Motor type: WEG
		Eff. 1/1: 89.5 %

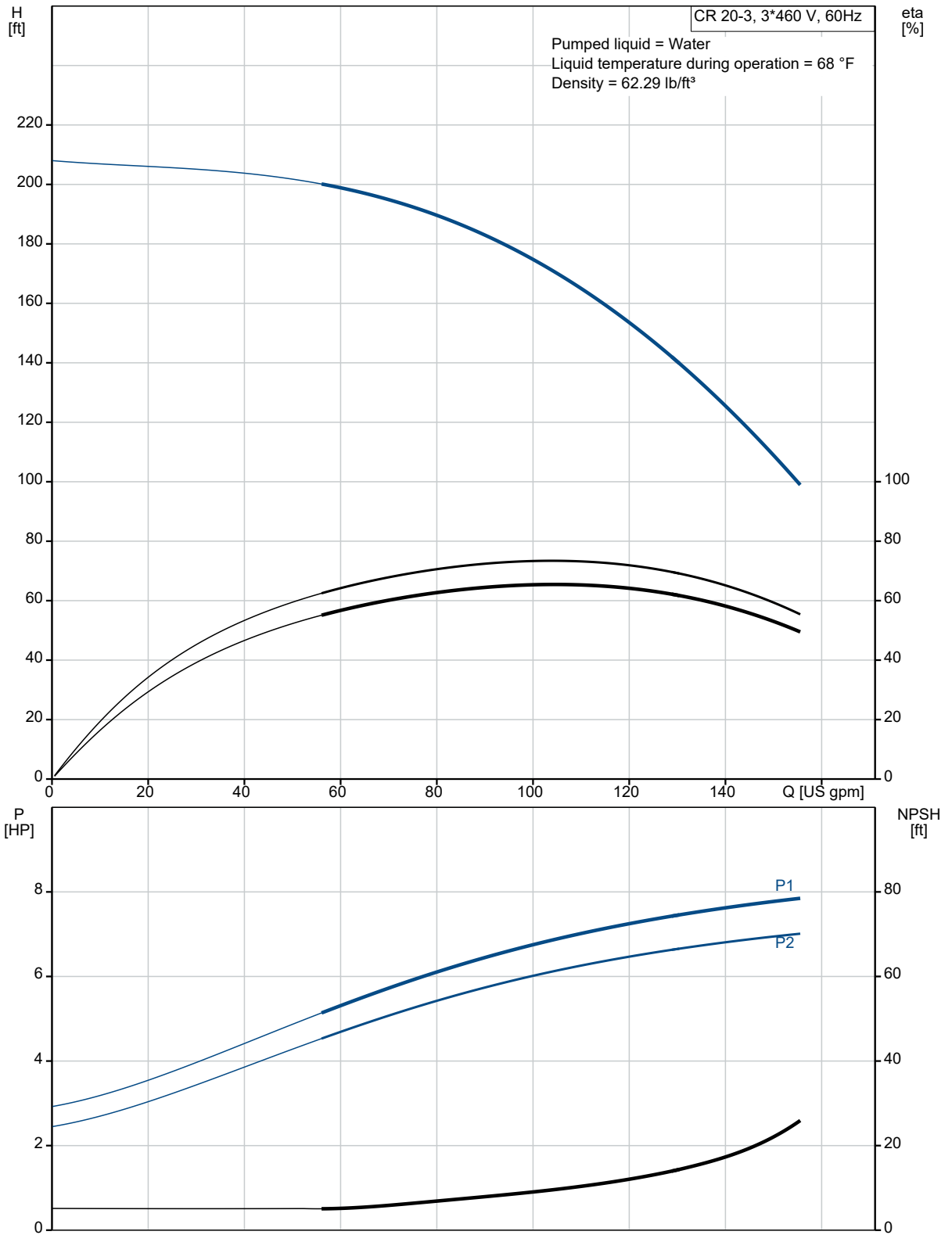

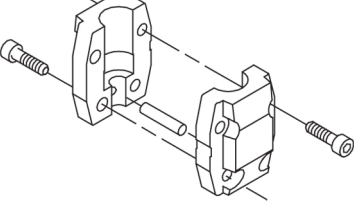

Count	Description
1	<p data-bbox="298 415 581 443"><b>CR 20-3 A-GJ-A-V-HQQV</b></p>  <p data-bbox="298 730 558 758">Product No.: <a href="#">99917756</a></p> <p data-bbox="298 793 1409 890">Vertical, multistage centrifugal pump with inlet and outlet ports on same the level (inline). The pump head and base are in cast iron – all other wetted parts are in stainless steel. A cartridge shaft seal ensures high reliability, safe handling, and easy access and service. Power transmission is via a rigid split coupling. Pipe connection is via combined ANSI-JIS flanges.</p> <p data-bbox="298 934 1003 961">The pump is fitted with a 3-phase, fan-cooled asynchronous motor.</p> <p data-bbox="298 995 607 1022"><b>Further product details</b></p> <p data-bbox="298 1031 1284 1079">Steel, cast iron and aluminium components have an epoxy-based coating made in a cathodic electro-deposition (CED) process.</p> <p data-bbox="298 1087 1312 1136">CED is a high-quality dip-painting process where an electrical field around the products ensures deposition of paint particles as a thin, well-controlled layer on the surface.</p> <p data-bbox="298 1144 813 1171">An integral part of the process is a pretreatment.</p> <p data-bbox="298 1180 792 1207">The entire process consists of these elements:</p> <ol data-bbox="321 1215 792 1318" style="list-style-type: none"><li>1) Alkaline-based cleaning.</li><li>2) Zinc phosphating.</li><li>3) Cathodic electro-deposition.</li><li>4) Curing to a dry film thickness 18-22 my m.</li></ol> <p data-bbox="298 1327 980 1354">The colour code for the finished product is NCS 9000/RAL 9005.</p> <p data-bbox="298 1388 380 1415"><b>Pump</b></p> <p data-bbox="298 1423 1409 1472">A standard split coupling connects the pump and motor shaft. It is enclosed in the pump head/motor stool by means of two coupling guards.</p>  <p data-bbox="298 1717 1398 1766">The pump head, pump head cover and flange for motor mounting is made in one piece. The pump head has a combined 1/2" priming plug and vent screw.</p>

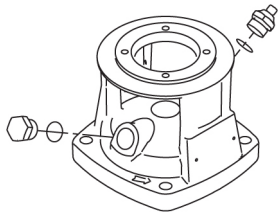

The pump is fitted with a balanced O-ring seal unit with a rigid torque-transmission system.

This seal type is assembled in a cartridge unit which makes replacement safe and easy.

Due to the balancing, this seal type is suitable for high-pressure applications.

The cartridge construction also protects the pump shaft from possible wear from a dynamic O-ring between pump shaft and shaft seal.

Primary seal:

- Rotating seal ring material: silicon carbide (SiC)
- Stationary seat material: silicon carbide (SiC)

This material pairing is used where higher corrosion resistance is required. The high hardness of this material pairing offers good resistance against abrasive particles.

Secondary seal material: FKM (fluorocarbon rubber)

FKM has excellent resistance to oils and chemicals. Above 90 °C, FKM should only be used in media without water.

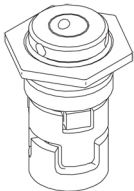

The shaft seal is screwed into the pump head.

The chambers and impellers are made of stainless-steel sheet. The chambers are provided with a PTFE neck ring offering improved sealing and high efficiency. The impellers have smooth surfaces, and the shape of the blades ensure a high efficiency.

The base is made of cast iron. The flanges and base are cast in one piece. The outlet side of the base has a drain plug. The pump is secured to the foundation by four bolts through the base plate.

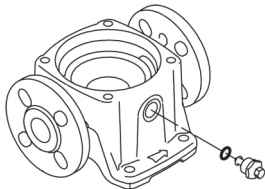

## Motor

The motor is a totally enclosed, fan-cooled motor with principal dimensions to IEC and DIN standards. The motor is flange-mounted with free-hole flange (FF).

Motor-mounting designation in accordance with IEC 60034-7: IM B 5 (Code I) / IM 3001 (Code II).

Electrical tolerances comply with IEC 60034.

The motor efficiency is classified as premium efficiency in accordance with EISA2007.



Company name:

Created by:

Phone:

Date: 12/13/2021

Count	Description
	<p>The motor does not incorporate motor protection and must be connected to a motor-protective circuit breaker which can be manually reset. The motor-protective circuit breaker must be set according to the rated current of the motor (I1/I).</p> <p>The motor can be connected to a variable speed drive for adjustment of pump performance to any duty point. Grundfos CUE offers a range of variable speed drives. Please find more information in Grundfos Product Center.</p> <p><b>Technical data</b></p> <p>Liquid:</p> <p>Pumped liquid: Water</p> <p>Liquid temperature range: -4 .. 194 °F</p> <p>Selected liquid temperature: 68 °F</p> <p>Density: 62.29 lb/ft<sup>3</sup></p> <p>Technical:</p> <p>Rated pump speed: 3467 rpm</p> <p>Rated flow: 111 US gpm</p> <p>Rated head: 159.1 ft</p> <p>Actual impeller diameter: 4.13 in</p> <p>Pump orientation: Vertical</p> <p>Shaft seal arrangement: Single</p> <p>Code for shaft seal: HQQV</p> <p>Approvals: CURUS</p> <p>Curve tolerance: ISO9906:2012 3B</p> <p>Materials:</p> <p>Base: Cast iron EN 1561 EN-GJL-200 ASTM A48-25B</p> <p>Impeller: Stainless steel EN 1.4301 AISI 304</p> <p>Bearing: SIC</p> <p>Installation:</p> <p>t max amb: 104 °F</p> <p>Maximum operating pressure: 232.06 psi</p> <p>Max pressure at stated temperature: 232 psi / 194 °F 232 psi / -4 °F</p> <p>Type of connection: ANSI / JIS</p> <p>Size of inlet connection: DN 50</p> <p>Size of outlet connection: DN 50</p> <p>Pressure rating for connection: PN 25</p> <p>Flange rating inlet: 250 lb</p> <p>Flange size for motor: 213TC</p> <p>Electrical data:</p> <p>Motor standard: NEMA</p> <p>Motor type: WEG</p>



Company name:

Created by:

Phone:

Date:

12/13/2021

Count	Description
	IE Efficiency class: IE3 / NEMA Premium
	Rated power - P2: 7.5 HP
	Power (P2) required by pump: 7.5 HP
	Main frequency: 60 Hz
	Rated voltage: 3 x 208-230/460 V
	Service factor: 1.15
	Rated current: 19,2-17,3/8,67 A
	Starting current: 760-760 %
	Cos phi - power factor: 0.89
	Rated speed: 3530 rpm
	IE efficiency: IE3 89,5%
	Motor efficiency at full load: 89.5 %
	Motor efficiency at 3/4 load: 88.5 %
	Motor efficiency at 1/2 load: 87.5 %
	Number of poles: 2
	Enclosure class (IEC 34-5): IP55
	Insulation class (IEC 85): F
	Motor Number: 99882381
	Controls:
	Frequency converter: NONE
	Others:
	DOE Pump Energy Index CL: 0.91
	Net weight: 236 lb
	Gross weight: 254 lb
	Shipping volume: 13.1 ft <sup>3</sup>
	Country of origin: US
	Custom tariff no.: 8413.70.2040



Company name:  
Created by:  
Phone:

Date: 12/13/2021

### 99917756 CR 20-3 A-GJ-A-V-HQQV 60 Hz

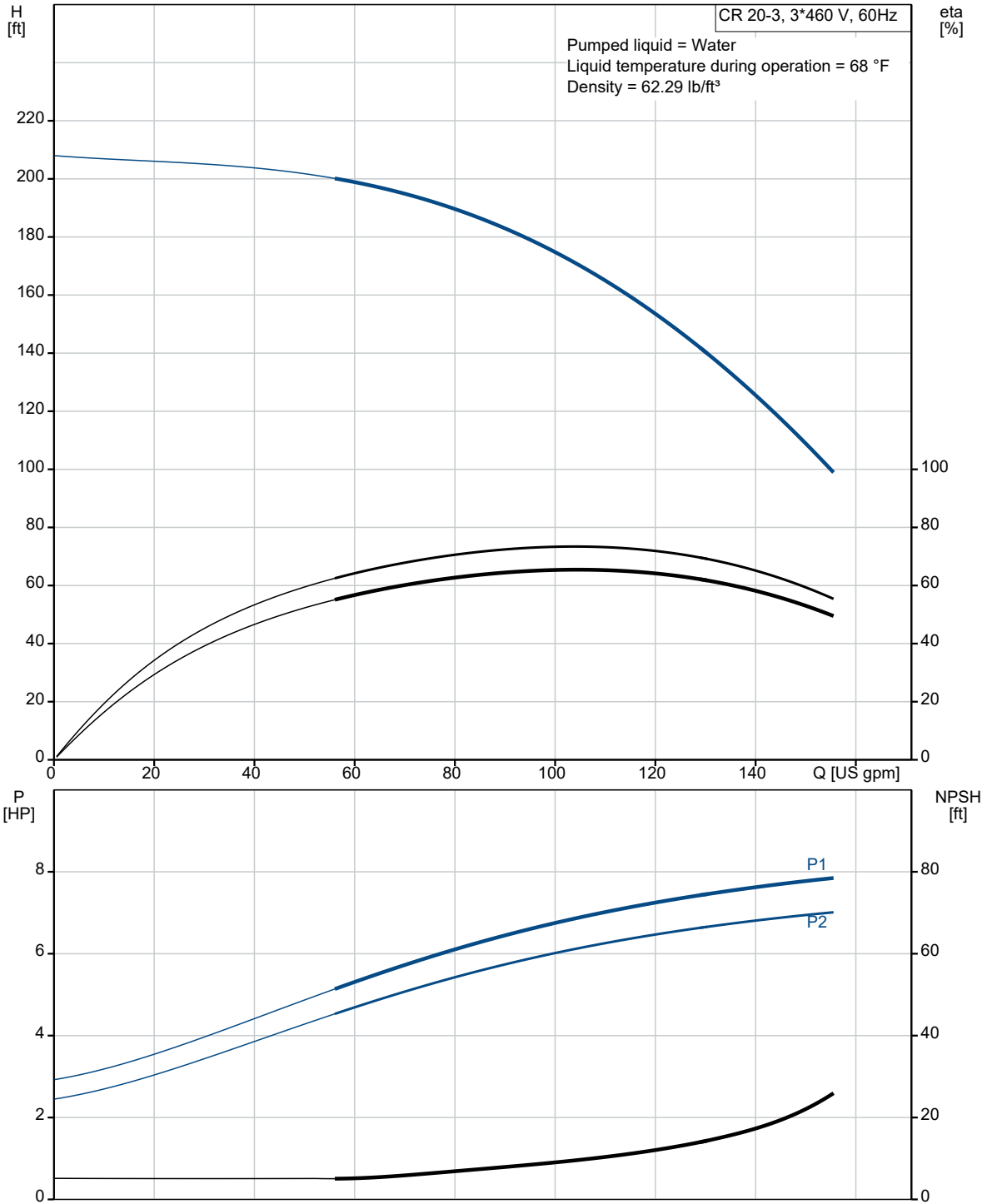





Company name:  
Created by:  
Phone:

Date: 12/13/2021

Description	Value
<b>General information:</b>	
Product name:	CR 20-3 A-GJ-A-V-HQQV
Product No.:	99917756
EAN:	5715114125901
<b>Technical:</b>	
Rated pump speed:	3467 rpm
Rated flow:	111 US gpm
Rated head:	159.1 ft
Maximum head:	206 ft
Actual impeller diameter:	4.13 in
Stages:	3
Impellers:	3
Number of reduced-diameter impellers:	0
Low NPSH:	N
Pump orientation:	Vertical
Shaft seal arrangement:	Single
Code for shaft seal:	HQQV
Approvals:	CURUS
Curve tolerance:	ISO9906:2012 3B
Pump version:	A
Model:	A
Cooling:	IC 411
<b>Materials:</b>	
Base:	Cast iron
Base:	EN 1561 EN-GJL-200
Base:	ASTM A48-25B
Impeller:	Stainless steel
Impeller:	EN 1.4301
Impeller:	AISI 304
Material code:	A
Code for rubber:	V
Bearing:	SIC
<b>Installation:</b>	
t max amb:	104 °F
Maximum operating pressure:	232.06 psi
Max pressure at stated temperature:	232 psi / 194 °F
Max pressure at stated temperature:	232 psi / -4 °F
Type of connection:	ANSI / JIS
Size of inlet connection:	DN 50
Size of outlet connection:	DN 50
Pressure rating for connection:	PN 25
Flange rating inlet:	250 lb
Flange size for motor:	213TC
Connect code:	GJ
<b>Liquid:</b>	

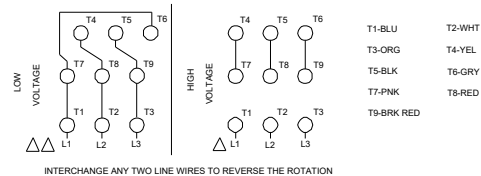
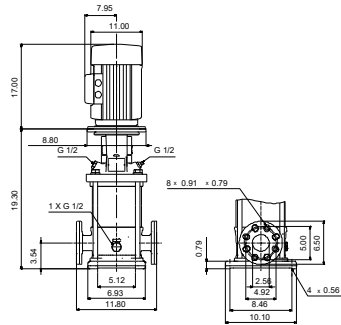
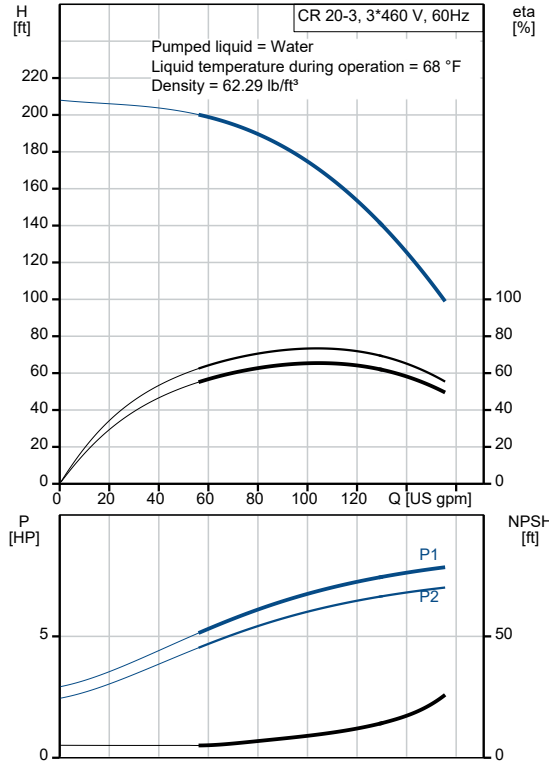



Company name:

Created by:

Phone:

Date: 12/13/2021

Description	Value
Pumped liquid:	Water
Liquid temperature range:	-4 .. 194 °F
Selected liquid temperature:	68 °F
Density:	62.29 lb/ft <sup>3</sup>
<b>Electrical data:</b>	
Motor standard:	NEMA
Motor type:	WEG
IE Efficiency class:	IE3 / NEMA Premium
Rated power - P2:	7.5 HP
Power (P2) required by pump:	7.5 HP
Main frequency:	60 Hz
Rated voltage:	3 x 208-230/460 V
Service factor:	1.15
Rated current:	19,2-17,3/8,67 A
Starting current:	760-760 %
Full load SF current:	19.9/9.97 A
Cos phi - power factor:	0.89
Rated speed:	3530 rpm
IE efficiency:	IE3 89,5%
Motor efficiency at full load:	89.5 %
Motor efficiency at 3/4 load:	88.5 %
Motor efficiency at 1/2 load:	87.5 %
Number of poles:	2
Enclosure class (IEC 34-5):	IP55
Insulation class (IEC 85):	F
Built-in motor protection:	NONE
Motor Number:	99882381
<b>Controls:</b>	
Frequency converter:	NONE
<b>Others:</b>	
DOE Pump Energy Index CL:	0.91
Net weight:	236 lb
Gross weight:	254 lb
Shipping volume:	13.1 ft <sup>3</sup>
Country of origin:	US
Custom tariff no.:	8413.70.2040



Company name:  
Created by:  
Phone:

Date: 12/13/2021

### 99917756 CR 20-3 A-GJ-A-V-HQQV 60 Hz

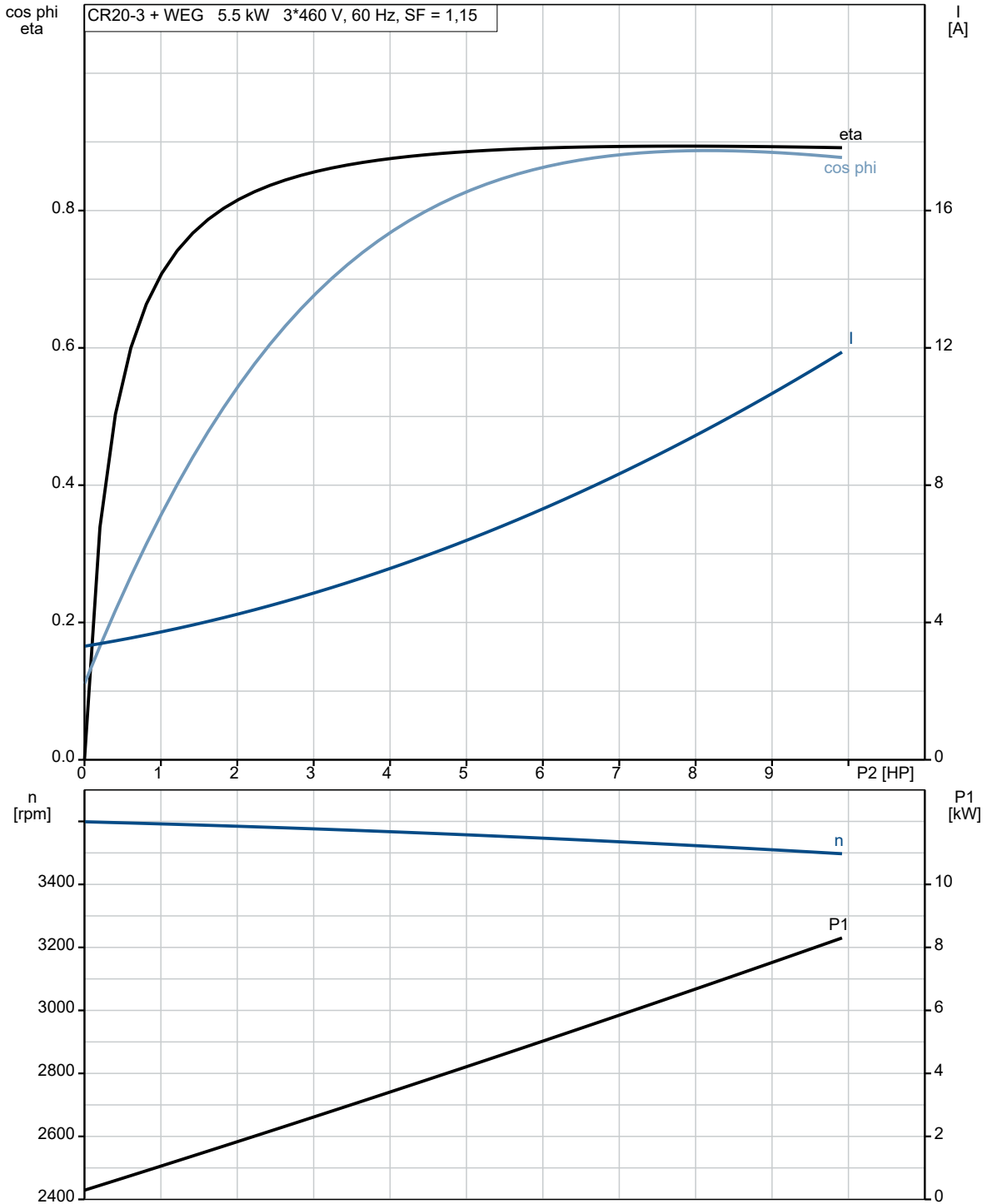



Company name:  
Created by:  
Phone:

Date: 12/13/2021

# 99917756 CR 20-3 A-GJ-A-V-HQQV 60 Hz

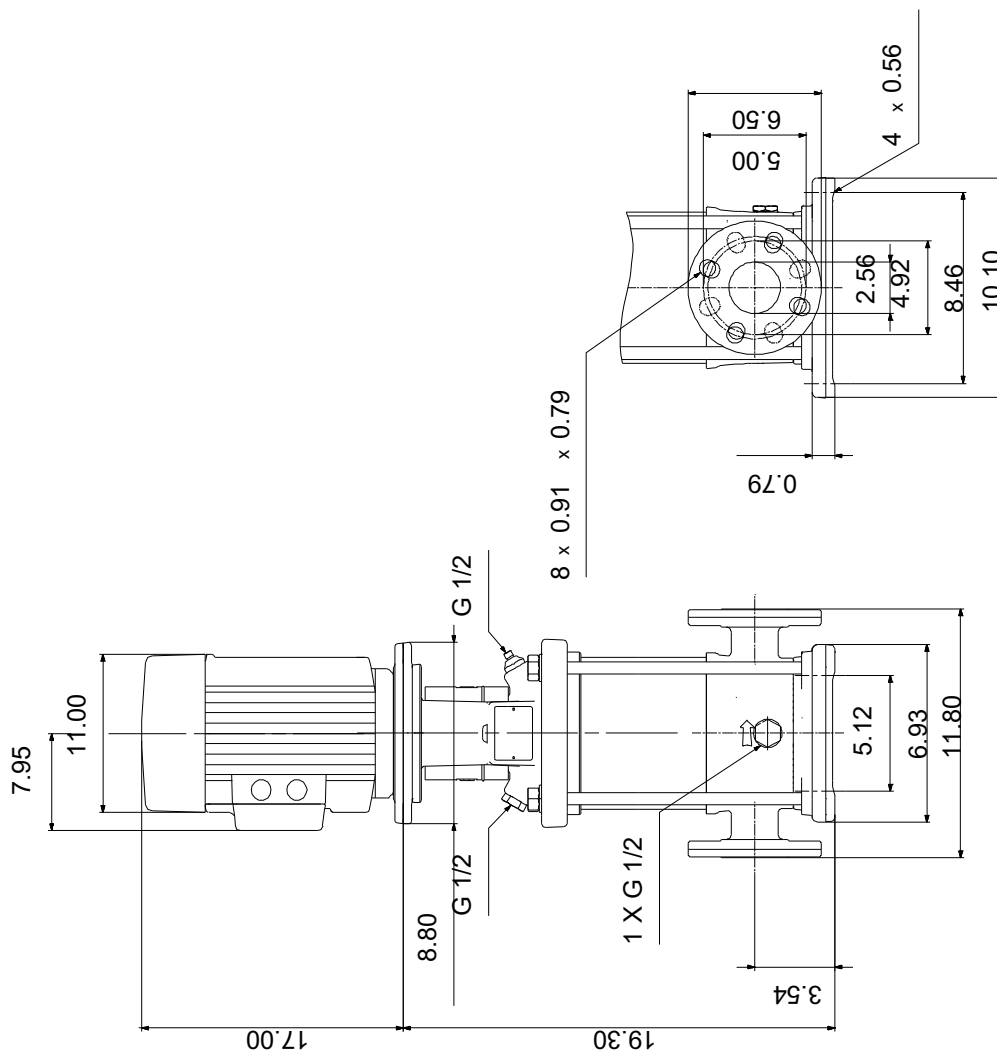

Note! All units are in [in] unless otherwise stated.  
Disclaimer: This simplified dimensional drawing does not show all details.



Company name:  
Created by:  
Phone:

Date: 12/13/2021

# 99917756 CR 20-3 A-GJ-A-V-HQQV 60 Hz

T2-WHT  
T4-YEL  
T6-GRY  
T8-RED

T1-BLU  
T3-ORG  
T5-BLK  
T7-PNK  
T9-BRK RED

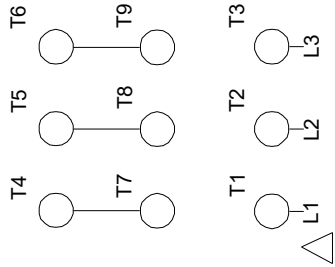

HIGH  
VOLTAGE

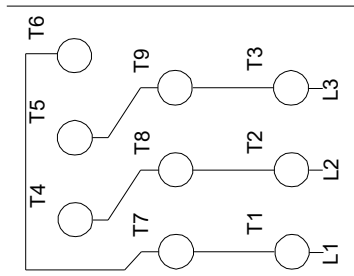

LOW  
VOLTAGE

INTERCHANGE ANY TWO LINE WIRES TO REVERSE THE ROTATION

All units are [in] unless otherwise presented.