

PROJECT: _____	UNIT TAG: _____	QUANTITY: _____
REPRESENTATIVE: _____	TYPE OF SERVICE: _____	DATE: _____
ENGINEER: _____	SUBMITTED BY: _____	DATE: _____
CONTRACTOR: _____	APPROVED BY: _____	DATE: _____
	ORDER NO.: _____	DATE: _____



### CRN 255-3-2 A-G-A-V-HQQV

Vertical, multistage centrifugal pump with suction and discharge ports on the same level. Pump materials in contact with the liquid are in high-grade stainless steel (EN 1.4401)

Product photo could vary from the actual product

Conditions of Service	Pump Data	Motor Data
Efficiency: _____	Liquid temperature range: -4 .. 194 °F	Rated power - P2: 201 HP
Liquid: Water	Maximum ambient temperature: 104 °F	Rated voltage: 460 V
Temperature: 68 °F	Shaft seal: HQQV	Main frequency: 60 Hz
NPSH required: ft	Product number: 99145537	Enclosure class: IP55
Specific Gravity: 1.000		Insulation class: F
		Motor protection: NONE
		Motor type: WEG
		Eff. 1/1: 95.4 %

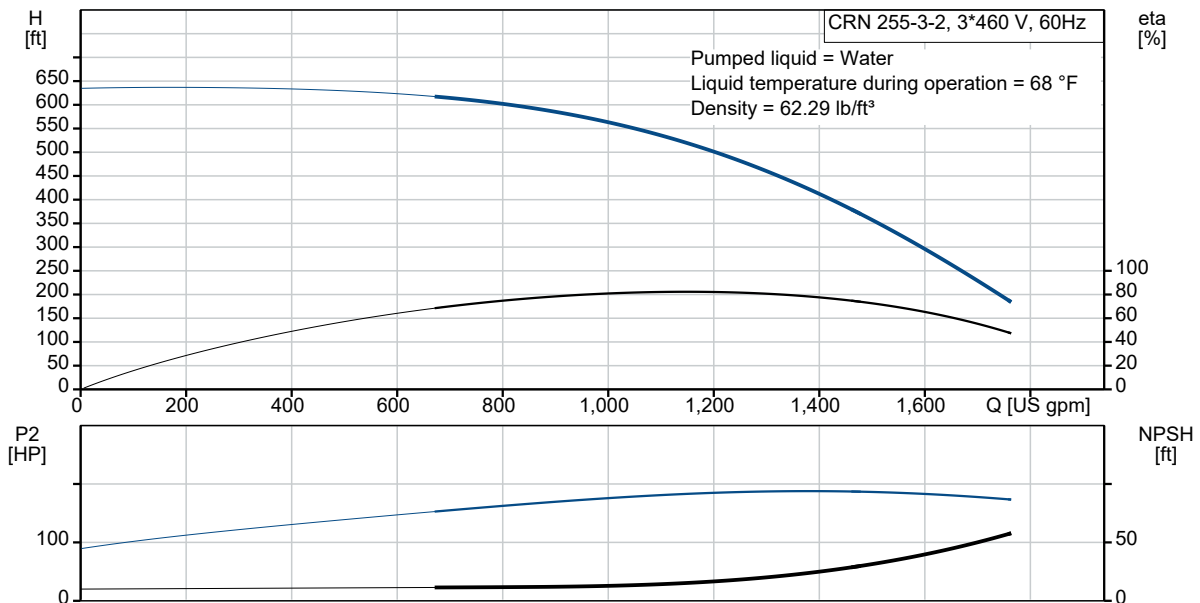

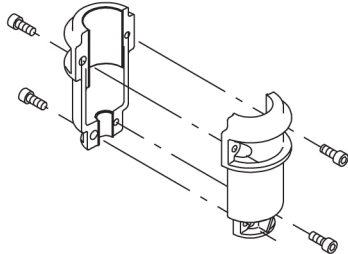

Count	Description
1	<p data-bbox="298 411 618 443"><b>CRN 255-3-2 A-G-A-V-HQQV</b></p> <div data-bbox="428 453 516 747" style="text-align: center;">  </div> <p data-bbox="686 758 1125 783" style="text-align: center;">Product photo could vary from the actual product</p> <p data-bbox="298 789 558 814">Product No.: <a href="#">99145537</a></p> <p data-bbox="298 848 1406 924">Vertical, multistage centrifugal pump with inlet and outlet ports on same the level (inline). Pump materials in contact with the liquid are in high-grade stainless steel. A built-in thrust-handling device absorbs hydraulic axial forces which enables the use of a standard motor.</p> <p data-bbox="298 934 1378 984">The Grundfos cartridge shaft seal ensures high reliability, safe handling, and easy access and service. Power transmission is via a rigid split coupling. Pipe connection is via ANSI flanges.</p> <p data-bbox="298 1020 1005 1045">The pump is fitted with a 3-phase, fan-cooled asynchronous motor.</p> <p data-bbox="298 1079 607 1108"><b>Further product details</b></p> <p data-bbox="298 1115 1284 1165">Steel, cast iron and aluminium components have an epoxy-based coating made in a cathodic electro-deposition (CED) process.</p> <p data-bbox="298 1171 1310 1222">CED is a high-quality dip-painting process where an electrical field around the products ensures deposition of paint particles as a thin, well-controlled layer on the surface.</p> <p data-bbox="298 1228 812 1253">An integral part of the process is a pretreatment.</p> <p data-bbox="298 1260 794 1285">The entire process consists of these elements:</p> <ol data-bbox="321 1291 794 1407" style="list-style-type: none"> <li>1) Alkaline-based cleaning.</li> <li>2) Zinc phosphating.</li> <li>3) Cathodic electro-deposition.</li> <li>4) Curing to a dry film thickness 18-22 my m.</li> </ol> <p data-bbox="298 1413 980 1438">The colour code for the finished product is NCS 9000/RAL 9005.</p> <p data-bbox="298 1472 378 1501"><b>Pump</b></p> <p data-bbox="298 1507 1393 1583">A long split coupling connects the pump and motor shaft. It is enclosed in the motor stool by means of two coupling guards. The long coupling makes it possible to replace the shaft seal without removing the motor from the pump.</p> <div data-bbox="298 1591 643 1843" style="text-align: center;">  </div>

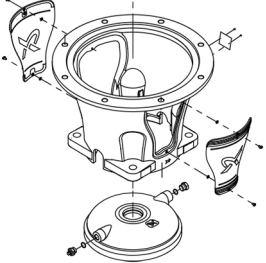
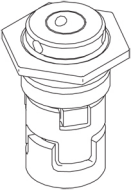
Count	Description
	<p>The motor stool connects the pump head and motor. The pump head has a combined 1/2" priming plug and vent screw.</p>  <p>The pump is fitted with a balanced O-ring seal unit with a rigid torque-transmission system. This seal type is assembled in a cartridge unit which makes replacement safe and easy. Due to the balancing, this seal type is suitable for high-pressure applications. The cartridge construction also protects the pump shaft from possible wear from a dynamic O-ring between pump shaft and shaft seal.</p> <p>Primary seal:</p> <ul style="list-style-type: none"><li>• Rotating seal ring material: silicon carbide (SiC)</li><li>• Stationary seat material: silicon carbide (SiC)</li></ul> <p>This material pairing is used where higher corrosion resistance is required. The high hardness of this material pairing offers good resistance against abrasive particles.</p> <p>Secondary seal material: FKM (fluorocarbon rubber)</p> <p>FKM has excellent resistance to oils and chemicals. Above 90 °C, FKM should only be used in media without water.</p>  <p>The shaft seal is screwed into the pump head.</p> <p>The chambers and impellers are made of stainless-steel sheet. The chambers are provided with a PEEK neck ring offering improved sealing and high efficiency. The impellers have smooth surfaces, and the shape of the blades ensure a high efficiency.</p> <p>The pump has a stainless-steel base mounted on a separate cast-iron base plate.</p> <p>The base and base plate are kept in position by the tension of the staybolts which hold the pump together.</p> <p>Both the inlet and the outlet side of the base have two pressure gauge tapplings.</p> <p>The pump is secured to the foundation by four bolts through the base plate.</p> <p>The flanges are fastened to the base by means of locking rings.</p>

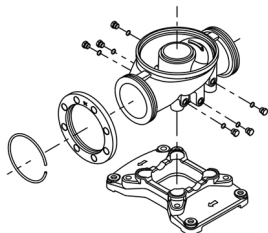

## Motor

The motor is a totally enclosed, fan-cooled motor with principal dimensions to IEC and DIN standards. The motor is flange-mounted with free-hole flange (FF).

Motor-mounting designation in accordance with IEC 60034-7: IM B 5 (Code I) / IM 3001 (Code II).

Electrical tolerances comply with IEC 60034.

The motor efficiency is classified as premium efficiency in accordance with EISA2007.

The motor does not incorporate motor protection and must be connected to a motor-protective circuit breaker which can be manually reset. The motor-protective circuit breaker must be set according to the rated current of the motor (I1/1).

A variable speed drive makes adjustment of pump performance to any duty point possible. If the motor is to be connected to a variable speed drive, the pump must be ordered with an electrically insulated motor bearing.

## Technical data

### Liquid:

Pumped liquid:	Water
Liquid temperature range:	-4 .. 194 °F
Selected liquid temperature:	68 °F
Density:	62.29 lb/ft <sup>3</sup>

### Technical:

Rated pump speed:	3576 rpm
Rated flow:	1350 US gpm
Rated head:	479 ft
Pump orientation:	Vertical
Shaft seal arrangement:	Single
Code for shaft seal:	HQQV
Approvals for drinking water:	NSF/ANSI 372
Curve tolerance:	ISO9906:2012 3B

### Materials:

Base:	Stainless steel EN 1.4408 ASTM A351 CF8M
Impeller:	Stainless steel EN 1.4401 AISI 316
Bearing:	WC/WC
Thrust handling device:	SiC/WC



Company name:

Created by:

Phone:

Date:

1/26/2022

Count	Description
	Material certified according to: European standards
	Installation:
	t max amb: 104 °F
	Maximum operating pressure: 362.59 psi
	Max pressure at stated temperature: 363 psi / 194 °F
	Type of connection: ANSI
	Size of suction port: 8 inch
	Size of outlet port: 8 inch
	Pressure rating for connection: 300 lb
	Flange size for motor: 447TSD
	Electrical data:
	Motor standard: NEMA
	Motor type: WEG
	IE Efficiency class: IE3 / NEMA Premium
	Rated power - P2: 201 HP
	Power (P2) required by pump: 201 HP
	Main frequency: 60 Hz
	Rated voltage: 3 x 460 V
	Service factor: 1.15
	Rated current: 222 A
	Starting current: 650 %
	Cos phi - power factor: 0.89
	Rated speed: 3570 rpm
	IE efficiency: IE3 95,4%
	Motor efficiency at full load: 95.4 %
	Motor efficiency at 3/4 load: 95.0 %
	Motor efficiency at 1/2 load: 94.1 %
	Number of poles: 2
	Enclosure class (IEC 34-5): IP55
	Insulation class (IEC 85): F
	Motor Number: 99883219
	Controls:
	Frequency converter: NONE
	Others:
	Net weight: 3010 lb
	Gross weight: 3490 lb
	Shipping volume: 138 ft <sup>3</sup>
	Thrust handling device: Y



Company name:  
Created by:  
Phone:

Date: 1/26/2022

### 99145537 CRN 255-3-2 A-G-A-V-HQQV 60 Hz

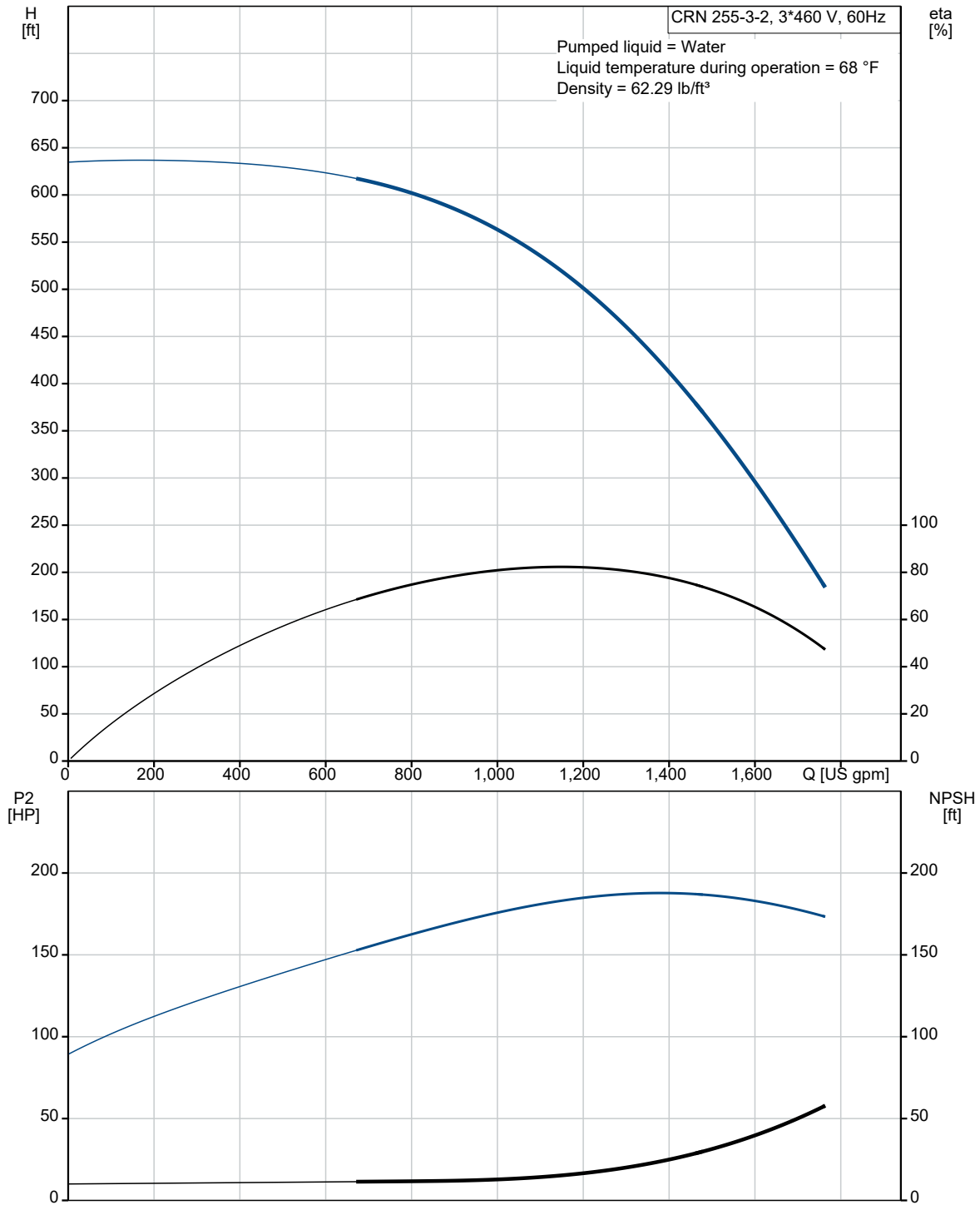



Company name:  
Created by:  
Phone:

Date: 1/26/2022

Description	Value
<b>General information:</b>	
Product name:	CRN 255-3-2 A-G-A-V-HQQV
Product No.:	99145537
EAN:	5712607599706
<b>Technical:</b>	
Rated pump speed:	3576 rpm
Rated flow:	1350 US gpm
Rated head:	479 ft
Maximum head:	634.5 ft
Stages:	3
Impellers:	3
Number of reduced-diameter impellers:	2
Low NPSH:	N
Pump orientation:	Vertical
Shaft seal arrangement:	Single
Code for shaft seal:	HQQV
Approvals for drinking water:	NSF/ANSI 372
Curve tolerance:	ISO9906:2012 3B
Pump version:	A
Model:	A
Cooling:	IC 411
<b>Materials:</b>	
Base:	Stainless steel
Base:	EN 1.4408
Base:	ASTM A351 CF8M
Impeller:	Stainless steel
Impeller:	EN 1.4401
Impeller:	AISI 316
Material code:	A
Code for rubber:	V
Bearing:	WC/WC
Thrust handling device:	SiC/WC
Material certified according to:	European standards
<b>Installation:</b>	
t max amb:	104 °F
Maximum operating pressure:	362.59 psi
Max pressure at stated temperature:	363 psi / 194 °F
Type of connection:	ANSI
Size of suction port:	8 inch
Size of outlet port:	8 inch
Pressure rating for connection:	300 lb
Flange size for motor:	447TSD
Connect code:	G
<b>Liquid:</b>	
Pumped liquid:	Water
Liquid temperature range:	-4 .. 194 °F

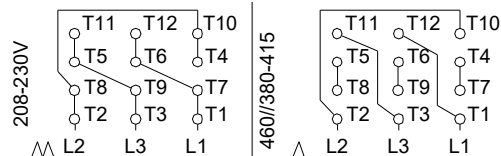
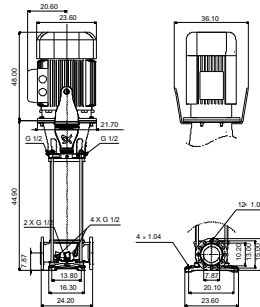
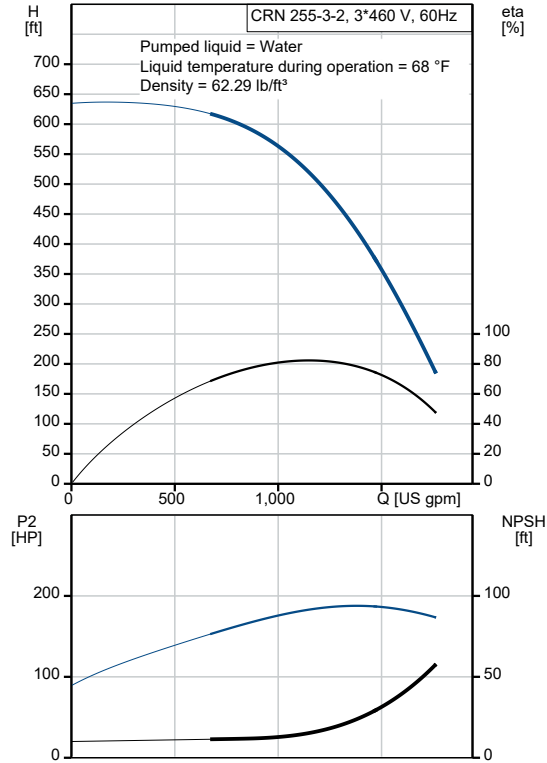





Company name:

Created by:

Phone:

Date:

1/26/2022

Description	Value
Selected liquid temperature:	68 °F
Density:	62.29 lb/ft <sup>3</sup>
<b>Electrical data:</b>	
Motor standard:	NEMA
Motor type:	WEG
IE Efficiency class:	IE3 / NEMA Premium
Rated power - P2:	201 HP
Power (P2) required by pump:	201 HP
Main frequency:	60 Hz
Rated voltage:	3 x 460 V
Service factor:	1.15
Rated current:	222 A
Starting current:	650 %
Full load SF current:	255 A
Cos phi - power factor:	0.89
Rated speed:	3570 rpm
IE efficiency:	IE3 95,4%
Motor efficiency at full load:	95.4 %
Motor efficiency at 3/4 load:	95.0 %
Motor efficiency at 1/2 load:	94.1 %
Number of poles:	2
Enclosure class (IEC 34-5):	IP55
Insulation class (IEC 85):	F
Built-in motor protection:	NONE
Motor Number:	99883219
<b>Controls:</b>	
Frequency converter:	NONE
<b>Others:</b>	
Net weight:	3010 lb
Gross weight:	3490 lb
Shipping volume:	138 ft <sup>3</sup>
Thrust handling device:	Y



Company name:  
Created by:  
Phone:

Date: 1/26/2022

### 99145537 CRN 255-3-2 A-G-A-V-HQQV 60 Hz

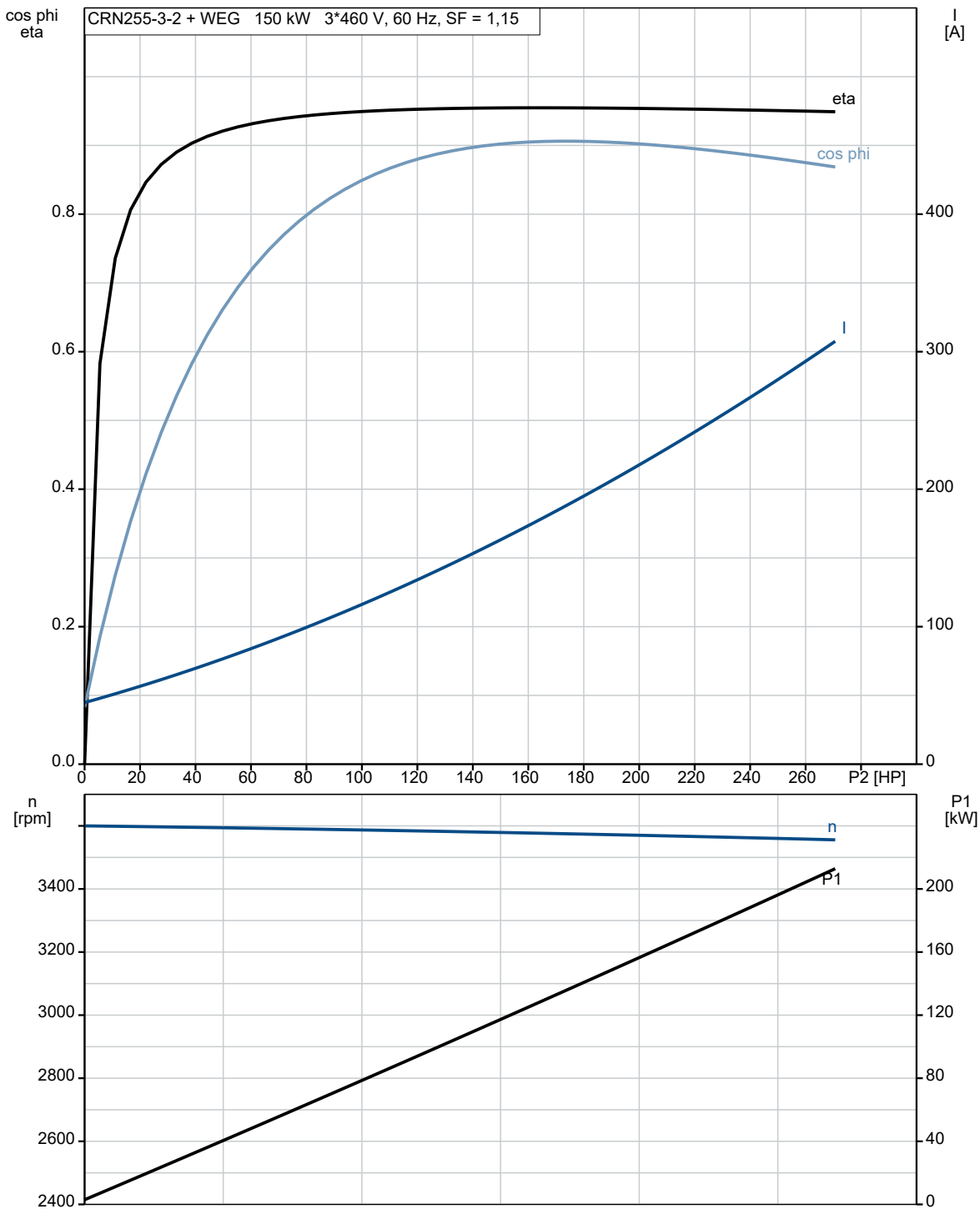



Company name:  
Created by:  
Phone:

Date: 1/26/2022

### 99145537 CRN 255-3-2 A-G-A-V-HQQV 60 Hz

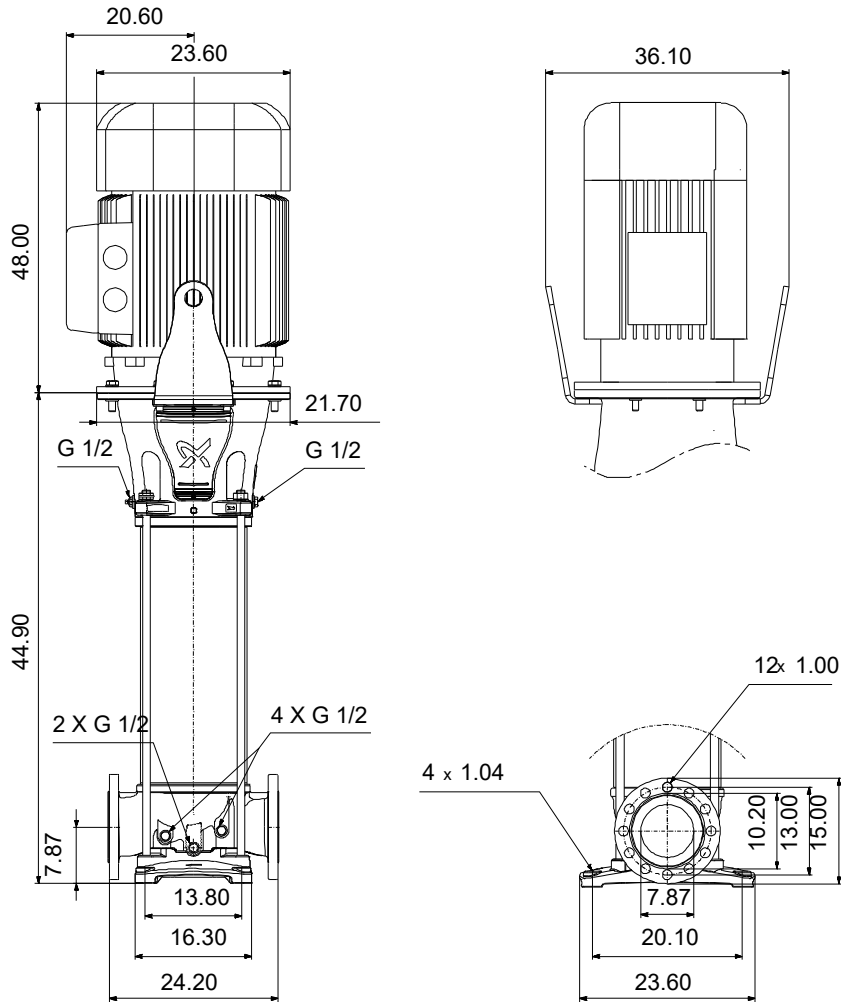

Note! All units are in [in] unless otherwise stated.  
Disclaimer: This simplified dimensional drawing does not show all details.



Company name:  
Created by:  
Phone:

Date: 1/26/2022

**99145537 CRN 255-3-2 A-G-A-V-HQQV 60 Hz**

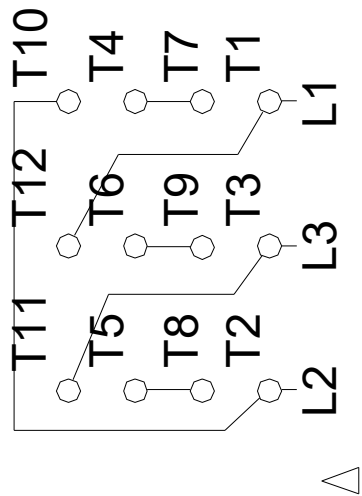

460//380-415

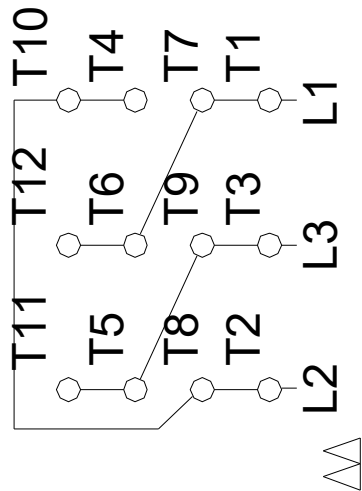

208-230V

All units are [in] unless otherwise presented.