

CRE, CRIE, CRNE, CRKE, SPKE, MTRE, CME

North America

Grundfos E-pumps with MLE frequency-controlled permanent-magnet motors

Installation and operating instructions



CRE, CRIE, CRNE, CRKE, SPKE, MTRE, CME

English (US)

Installation and operating instructions 4

Français (CA)

Notice d'installation et de fonctionnement 67

Español (MX)

Instrucciones de instalación y operación 134

Appendix A **200**

Original installation and operating instructions

Table of contents

1. Limited warranty	5	8.20 "Ramps"	51
2. General information	5	8.21 "Standstill heating"	52
2.1 Hazard statements	5	8.22 "Motor bearing monitoring"	52
2.2 Notes	5	8.23 "Service"	52
2.3 Abbreviations and definitions	6	8.24 "Number" ("Pump number")	52
3. Product introduction	6	8.25 "Radio communication" ("Enable/disable radio comm.")	53
3.1 Product description	6	8.26 "Language"	53
3.2 Identification	7	8.27 "Date and time" ("Set date and time")	53
3.3 Bus signal	8	8.28 "Unit configuration" ("Units")	53
3.4 Grundfos Eye	9	8.29 "Buttons on product" ("Enable/disable settings")	53
3.5 Signal relays	10	8.30 "Delete history"	54
4. Receiving the product	11	8.31 "Define Home display"	54
4.1 Transporting the product	11	8.32 "Display settings"	54
4.2 Inspecting the product	11	8.33 "Store settings" ("Store actual settings")	54
5. Mechanical installation	11	8.34 "Recall settings" ("Recall stored settings")	54
5.1 Handling the product	11	8.35 "Pump name"	54
5.2 Mounting	11	8.36 "Connection code"	54
5.3 Cable entries	11	8.37 "Run start-up guide"	55
5.4 Cable glands	11	8.38 "Alarm log"	55
5.5 Ensuring motor cooling	11	8.39 "Warning log"	55
5.6 Outdoor installation	12	8.40 "Assist"	55
5.7 Drain holes	12	8.41 "Assisted pump setup"	55
5.8 Changing the position of the control (operating) panel	12	8.42 "Setup, analog input"	56
6. Electrical installation	13	8.43 "Setting of date and time"	56
6.1 Protection against electric shock, indirect contact	13	8.44 "Multi-pump setup" ("Setup of multi-pump system")	56
6.2 Cable requirements	13	8.45 "Description of control mode"	58
6.3 Power supply	14	8.46 "Assisted fault advice"	58
6.4 Additional protection	15	9. Description of settings	59
6.5 Connection terminals	15	9.1 Priority of settings	59
6.6 Signal cables	18	9.2 Factory settings	60
6.7 Bus connection cable	18	10. Servicing the product	62
6.8 Installing a communication interface module	19	10.1 Motor	62
7. User interfaces	20	10.2 Pump	62
7.1 Standardoperatingpanel	21	10.3 Cleaning the product	62
7.2 Advancedoperatingpanel	23	11. Technical data	62
7.3 Grundfos GO Remote	28	11.1 Operating conditions	62
7.4 R100 remote control	32	11.2 Megging	63
8. Description of functions	34	11.3 Technical data, single-phase motors	63
8.1 "Setpoint"	34	11.4 Technical data, three-phase motors	63
8.2 "Operating mode"	34	11.5 Inputs/outputs	64
8.3 "Set manual speed"	34	11.6 Other technical data	65
8.4 "Control mode"	34	12. Disposing of the product	66
8.5 "Analog inputs"	38	13. Document quality feedback	66
8.6 "Pt100/1000 inputs"	39		
8.7 "Digital inputs"	40		
8.8 "Digital inputs/outputs"	41		
8.9 "Signal relays" 1 and 2 ("Relay outputs")	42		
8.10 "Analog output"	42		
8.11 "Controller" ("Controller settings")	43		
8.12 "Operating range"	44		
8.13 "External setpoint function"	45		
8.14 "Predefined setpoints"	47		
8.15 "Limit-exceeded function"	48		
8.16 "LiqTec" ("LiqTec function")	49		
8.17 "Stop function" ("Low-flow stop function")	49		
8.18 "Pipe filling function"	51		
8.19 "Pulse flowmeter" ("Pulse flowmeter setup")	51		

1. Limited warranty

Products manufactured by Grundfos Pumps Corporation (Grundfos) are warranted to the original user only to be free of defects in material and workmanship for a period of 24 months from date of installation, but not more than 30 months from date of manufacture. Grundfos' liability under this warranty shall be limited to repairing or replacing at Grundfos' option, without charge, F.O.B. Grundfos' factory or authorized service station, any product of Grundfos manufacture. Grundfos will not be liable for any costs of removal, installation, transportation, or any other charges that may arise in connection with a warranty claim. Products which are sold, but not manufactured by Grundfos, are subject to the warranty provided by the manufacturer of said products and not by Grundfos' warranty. Grundfos will not be liable for damage or wear to products caused by abnormal operating conditions, accident, abuse, misuse, unauthorized alteration or repair, or if the product was not installed in accordance with Grundfos' printed installation and operating instructions and accepted codes of good practice. The warranty does not cover normal wear and tear. To obtain service under this warranty, the defective product must be returned to the distributor or dealer of Grundfos' products from which it was purchased together with proof of purchase and installation date, failure date and supporting installation data. Unless otherwise provided, the distributor or dealer will contact Grundfos or an authorized service station for instructions. Any defective product to be returned to Grundfos or a service station must be sent freight prepaid; documentation supporting the warranty claim and/or a Return Material Authorization must be included if so instructed. Grundfos will not be liable for any incidental or consequential damages, losses, or expenses arising from installation, use, or any other causes. There are no express or implied warranties, including merchantability or fitness for a particular purpose, which extend beyond those warranties described or referred to above. Some jurisdictions do not allow the exclusion or limitation of incidental or consequential damages and some jurisdictions do not allow limitations on how long implied warranties may last. Therefore, the above limitations or exclusions may not apply to you. This warranty gives you specific legal rights and you may also have other rights which vary from jurisdiction to jurisdiction. Products which are repaired or replaced by Grundfos or authorized service center under the provisions of these limited warranty terms will continue to be covered by Grundfos warranty only through the remainder of the original warranty period set forth by the original purchase date.

2. General information



Read this document before you install the product. Installation and operation must comply with local regulations and accepted codes of good practice.

These installation and operating instructions are a supplement to the installation and operating instructions for the corresponding standard pumps CR, CRI, CRN, SPK, MTR and CM. For instructions not mentioned specifically in this manual, see the installation and operating instructions for the standard pump.

2.1 Hazard statements

The symbols and hazard statements below may appear in Grundfos installation and operating instructions, safety instructions and service instructions.



DANGER

Indicates a hazardous situation which, if not avoided, will result in death or serious personal injury.



WARNING

Indicates a hazardous situation which, if not avoided, could result in death or serious personal injury.



CAUTION

Indicates a hazardous situation which, if not avoided, could result in minor or moderate personal injury.

The hazard statements are structured in the following way:



SIGNAL WORD

Description of the hazard

Consequence of ignoring the warning

- Action to avoid the hazard.

2.2 Notes

The symbols and notes below may appear in Grundfos installation and operating instructions, safety instructions and service instructions.



Observe these instructions for explosion-proof products.



A blue or gray circle with a white graphical symbol indicates that an action must be taken.



A red or gray circle with a diagonal bar, possibly with a black graphical symbol, indicates that an action must not be taken or must be stopped.



If these instructions are not observed, it may result in malfunction or damage to the equipment.



Tips and advice that make the work easier.

2.3 Abbreviations and definitions

AI	Analog input.
AL	Alarm, out of range at lower limit.
AO	Analog output.
AU	Alarm, out of range at upper limit.
CIM	Communication interface module.
Current sinking	The ability to draw current into the terminal and guide it towards GND in the internal circuitry.
Current sourcing	The ability to push current out of the terminal and into an external load which must return it to GND.
DI	Digital input.
DO	Digital output.
FM	Functional module.
GDS	Grundfos Digital Sensor. Factory-fitted sensor in some Grundfos pumps.
GENIbus	Proprietary Grundfos fieldbus standard.
GFCI	Ground fault circuit interrupter. (USA and Canada).
GND	Ground.
Grundfos Eye	Status indicator light.
LIVE	Low voltage with the risk of electric shock if the terminals are touched.
OC	Open collector: Configurable open-collector output.
PE	Protective earth (ground).
PELV	Protective extra-low voltage. A voltage that cannot exceed ELV under normal conditions and under single-fault conditions, except earth (ground) faults in other circuits.
SELV	Safety extra-low voltage. A voltage that cannot exceed ELV under normal conditions and under single-fault conditions, including earth (ground) faults in other circuits.

3. Product introduction

3.1 Product description

Grundfos E-pumps are fitted with frequency-controlled permanent-magnet motors for single-phase or three-phase power supply connection.

3.1.1 Pumps without factory-fitted sensor

The pumps have a built-in PI controller and can be set for an external sensor enabling the control of the following parameters:

- constant pressure
- constant differential pressure
- constant temperature
- constant differential temperature
- constant flow rate
- constant level
- constant curve
- constant other value.

The pumps have been factory-set to constant-curve control mode. You can change the control mode with R100 or Grundfos GO Remote.

3.1.2 Pumps with factory-fitted pressure sensor

The pumps have a built-in PI controller and are set for a pressure sensor enabling the control of the outlet pressure.

The pumps have been factory-set to constant-pressure control mode. The pumps are typically used to keep a constant pressure in variable-demand systems.

3.1.3 Settings

The description of settings applies both to pumps without factory-fitted sensor and to pumps with a factory-fitted pressure sensor.

Setpoint

You can set the desired setpoint in three ways:

- on the pump operating panel
- via an input for external setpoint signal
- with the Grundfos wireless R100 remote control or Grundfos GO Remote.

Other settings

Make all other settings with R100 or Grundfos GO Remote.

You can read important parameters, such as the actual value of the control parameter and power consumption, via R100 or Grundfos GO Remote.

If special or customized settings are required, use Grundfos PC Tool. Contact your local Grundfos company for more information.

3.1.4 Radio communication

This product incorporates a radio module for remote control which is a class 1 device and which you can use anywhere in the EU without restrictions.

For use in USA and Canada, see the appendix on installation in the USA and Canada.

Some variants of the product and products sold in China and Korea have no radio module.

This product can communicate with Grundfos GO Remote and other products of the same type via the built-in radio module.

In some cases, an external antenna may be required. Only Grundfos-approved external antennas may be connected to this product, and only by a Grundfos-approved installer.

3.1.5 Battery

A Li-ion battery is fitted in CRE, CRIE, CRNE, CRKE, SPKE, MTRE and CME pumps. The Li-ion battery complies with the Battery Directive (2006/66/EC). The battery does not contain mercury, lead and cadmium.

3.2 Identification

3.2.1 Nameplate

The information on the pump nameplate is described below.

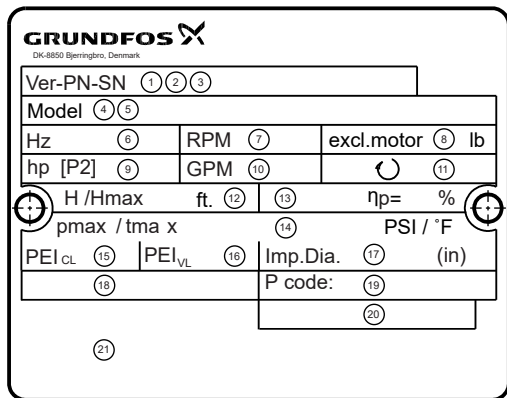

TM075722

Example of a nameplate

Pos.	Description
1	Version
2	Product number
3	Serial number
4	Model
5	Type designation
6	Frequency
7	Rated speed
8	Weight excluding motor
9	Motor-rated power output
10	Rated flow rate
11	Direction of rotation CCW: Counterclockwise CW: Clockwise
12	Head at rated flow rate / Maximum head
13	Hydraulic efficiency at rated flow rate
14	Maximum system pressure / Maximum liquid temperature. Note that this field may have two sets of data.
15	Pump Energy Index, constant load
16	Pump Energy Index, variable load
17	Impeller diameter
18	External reference (Other Equipment Manufacturer number)
19	Production code
20	Country of origin
21	Approval marks

3.2.2 Identification of functional module

You can identify the fitted module in one of the following ways:

Grundfos GO Remote

You can identify the functional module in the "Fitted modules" menu under "Status".

Pump display

For pumps fitted with the advanced operating panel, you can identify the functional module in the "Module type" menu under "Status".

Motor nameplate

You can identify the fitted module on the motor nameplate. See the figure below.

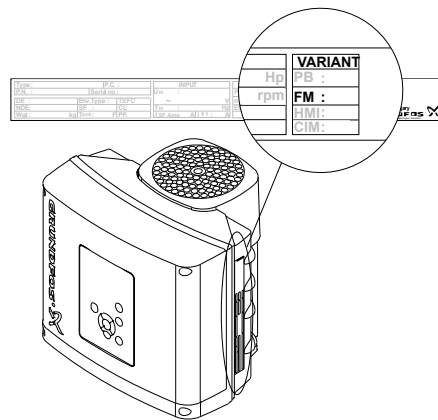

TM061889

Identification of functional module

VARIANT	Description
FM 200	Standard functional module
FM 300	Advanced functional module

3.2.3 Identification of operating panel

You can identify the fitted module in one of the following ways:

Grundfos GO Remote

You can identify the operating panel in the "Fitted modules" menu under "Status".

Pump display

For pumps fitted with the advanced operating panel, you can identify the operating panel in the "Module type" menu under "Status".

Motor nameplate

You can identify the fitted operating panel on the motor nameplate. See the figure below.

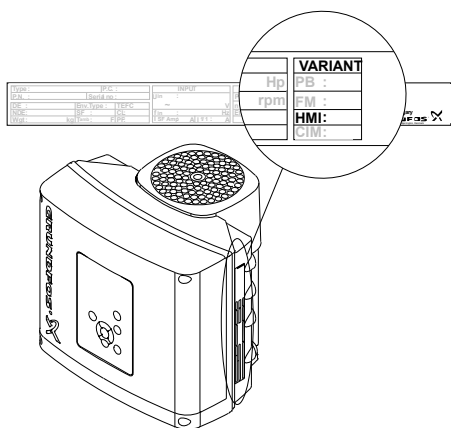

TM064013

Identification of operating panel

Variant	Description
HMI 200	Standard operating panel
HMI 300	Advanced operating panel

3.3 Bus signal

The pump supports serial communication via an RS-485 input. The communication is carried out according to the Grundfos GENIbus protocol and enables connection to other pumps as well as a building management system or another external control system.

Via a bus signal, you can remote-set pump operating parameters, such as setpoint and operating mode. At the same time, the pump can, via the bus, provide status information about important parameters, such as actual value of control parameter, input power and fault indications.

Contact Grundfos for further information.



If you use a bus signal, the number of settings available via R100 or Grundfos GO Remote are reduced.

3.4 Grundfos Eye

The operating condition of the pump is indicated by Grundfos Eye on the operating panel. See the figure below, A.

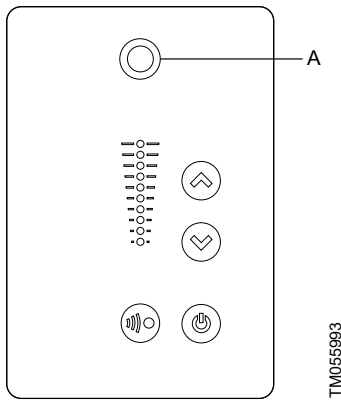

TM055993

Grundfos Eye



































































Grundfos Eye	Indication	Description
	No lights are on.	The power is off. The pump is not running.
	The two opposite green indicator lights are rotating in the direction of rotation of the pump when seen from the non-drive end.	The power is on. The pump is running.
	The two opposite green indicator lights are permanently on.	The power is on. The pump is not running.
	One yellow indicator light is rotating in the direction of rotation of the pump when seen from the non-drive end.	Warning. The pump is running.
	One yellow indicator light is permanently on.	Warning. The pump is stopped.
	The two opposite red indicator lights flash simultaneously.	Alarm. The pump is stopped.
	The green indicator light in the middle flashes quickly four times.	This is a feedback signal which the pump gives in order to ensure identification of itself.
	The green indicator light in the middle flashes continuously.	Grundfos GO Remote or another pump is trying to communicate with the pump. Press on the pump operating panel to allow communication.
	The green indicator light in the middle is permanently on.	Remote control with Grundfos GO Remote via radio. The pump is communicating with Grundfos GO Remote via radio connection.
	The green indicator light in the middle flashes quickly while Grundfos GO Remote is exchanging data with the pump. It takes a few seconds.	Remote control with Grundfos GO Remote via infrared light. The pump is receiving data from Grundfos GO Remote via infrared communication.

3.5 Signal relays

The pump has two outputs for potential-free signals via two internal relays.

You can set the signal outputs to "Operation", "Pump running", "Ready", "Alarm" and "Warning".

The functions of the two signal relays appear from the table below:

Description	Grundfos Eye	Contact position of signal relays when activated					"Operating mode"
		"Operation"	"Pump running"	"Ready"	"Alarm"	"Warning"	
The power is off.	 Off						-
The pump runs in "Normal" mode.	 Green, rotating						"Normal", "Min." or "Max."
The pump runs in "Manual" mode.	 Green, rotating						"Manual"
The pump is in operating mode "Stop".	 Green, steady						"Stop"
Warning, but the pump is running.	 Yellow, rotating						"Normal", "Min." or "Max."
Warning, but the pump runs in "Manual" mode.	 Yellow, rotating						"Manual"
Warning, but the pump was stopped via a "Stop" command.	 Yellow, steady						"Stop"
Alarm, but the pump is running.	 Red, rotating						"Normal", "Min." or "Max."
Alarm, but the pump runs in "Manual" mode.	 Red, rotating						"Manual"
The pump is stopped due to an alarm.	 Red, flashing						"Stop"
The pump is stopped due to "Low-flow stop function".	 Green, steady						"Normal"

4. Receiving the product

4.1 Transporting the product



WARNING

Falling objects

Death or serious personal injury

- Secure the product during transportation to prevent it from tilting or falling down.



CAUTION

Crushing of feet

Minor or moderate personal injury

- Wear safety shoes when moving the product.

- Motors from 3 to 5 Hp (2.2 to 5.5 kW): Do not stack more than two motors in their original packaging.
- Motors from 7 1/2 to 15 Hp (5.5 to 11 kW): Do not stack the motors.

4.2 Inspecting the product

Before installing the product, do the following:

1. Check that the product is as ordered.
2. Check that no visible parts have been damaged.
3. If parts are damaged or missing, contact your local Grundfos sales company.

5. Mechanical installation

5.1 Handling the product

Observe local regulations setting limits for manual lifting or handling. The motor weight is stated on the nameplate.



CAUTION

Back injury

Minor or moderate personal injury

- Use lifting equipment.



CAUTION

Crushing of feet

Minor or moderate personal injury

- Wear safety shoes and attach lifting equipment to the motor eyebolts when handling the product.



Do not lift the product by the terminal box.

5.2 Mounting



CAUTION

Crushing of feet

Minor or moderate personal injury

- Secure the product to a solid foundation by bolts through the holes in the flange or the base plate.



In order to maintain the UL mark, additional requirements apply to the equipment. See the appendix on installation in the USA and Canada.

5.3 Cable entries

See the size of the cable entries in the section on other technical data.

Related information

[11.6 Other technical data](#)

[11.6 Autres caractéristiques techniques](#)

[11.6 Otros datos técnicos](#)

5.4 Cable glands

The number and size of cable glands delivered with the pump depends on the motor size. See the section on other technical data.

Related information

[11.6 Other technical data](#)

[11.6 Autres caractéristiques techniques](#)

[11.6 Otros datos técnicos](#)

5.5 Ensuring motor cooling

Leave at least 2 in. (50 mm) between the end of the fan cover and a wall or other fixed objects. See the figure below.

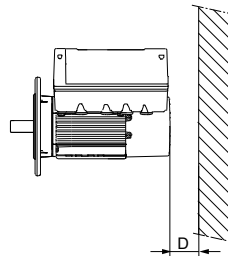

Minimum distance (D) from the motor to a wall or other fixed objects

5.6 Outdoor installation

The enclosure class of MLE motor is a NEMA 3 rating. If you install the motor outdoors, provide the motor with a suitable cover and open the drain holes to avoid condensation on the electronic components. See figs Examples of covers (not supplied by Grundfos) and Drain holes.



When fitting a cover to the motor, observe the guideline in the section on ensuring motor cooling.

The cover must be sufficiently large to ensure that the motor is not exposed to direct sunlight, rain or snow. Grundfos does not supply covers. We therefore recommend that you have a cover built for the specific application. In areas with high humidity, we recommend that you enable the built-in standstill heating function. See the section on standstill heating.

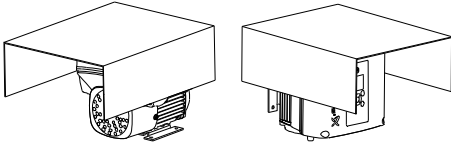

TM053496

Examples of covers (not supplied by Grundfos)



In order to maintain the UL mark, additional requirements apply to the equipment. See the appendix on installation in the USA and Canada.

Related information

[5.5 Ensuring motor cooling](#)

[5.7 Drain holes](#)

[8.21 "Standstill heating"](#)

5.7 Drain holes

When the motor is installed in moist surroundings or areas with high humidity, the bottom drain hole must be open. The enclosure class of the motor will then be lower. This helps prevent condensation in the motor as the motor becomes self-venting, and it allows water and humid air to escape.

The motor has a plugged drain hole on the drive side. You can turn the flange 90° to both sides or 180°.

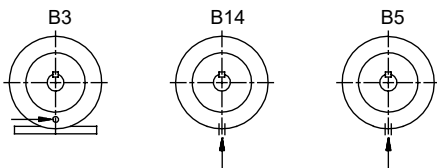

TM029037

Drain holes

5.8 Changing the position of the control (operating) panel

DANGER

Electric shock

Death or serious personal injury



- Switch off the power supply to the motor and to the signal relays. Wait at least 5 minutes before starting any work on the motor. Make sure that the power supply cannot be switched on accidentally.

You can turn the operating panel 180°. Follow the instructions below.

1. Loosen the four screws (TX25) of the terminal box cover.

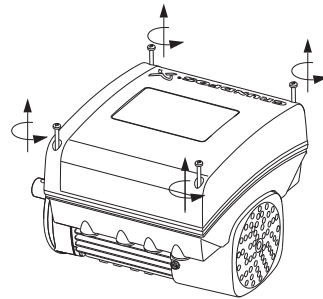

TM055351

Loosening the screws

2. Remove the terminal box cover.

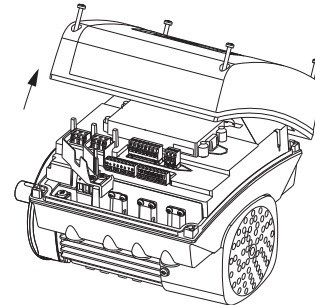

TM055352

Removing the terminal box cover

3. Press and hold in the two locking tabs (A) while gently lifting the plastic cover (B).

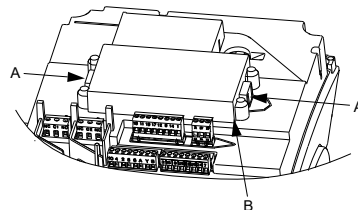

TM055353

Lifting the plastic cover

4. Turn the plastic cover 180°.



Do not twist the cable more than 90°.

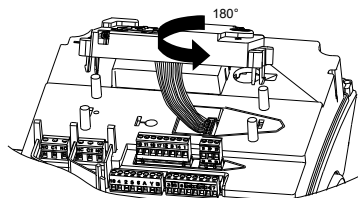

TM055354

Turning the plastic cover

5. Position the plastic cover correctly on the four rubber pins (C). Make sure that the locking tabs (A) are placed correctly.

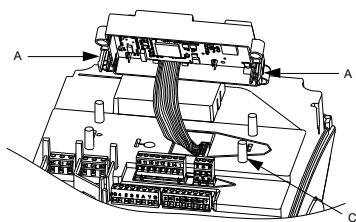

TM055355

Positioning the plastic cover

6. Fit the terminal box cover, and make sure that it is also turned 180° so that the buttons on the operating panel are aligned with the buttons on the plastic cover.
7. Tighten the four screws (TX25) with 5 Nm.

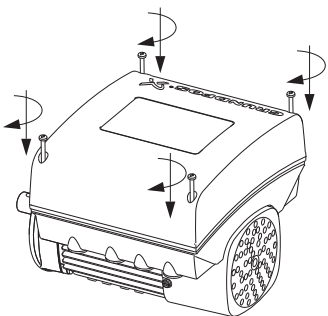

TM055356

Fitting the terminal box cover

6. Electrical installation

DANGER

Electric shock

Death or serious personal injury



- Switch off the power supply to the motor and to the signal relays. Wait at least 5 minutes before you make any connections in the terminal box. Make sure that the power supply cannot be accidentally switched on.

DANGER

Electric shock

Death or serious personal injury



- Check that the supply voltage and frequency correspond to the values stated on the nameplate.

If the power supply cable is damaged, it must be replaced by the manufacturer, the manufacturer's service partner or a similarly qualified person.

The user or the installer is responsible for the installation of correct grounding and protection according to local regulations. All operations must be carried out by a qualified electrician.

6.1 Protection against electric shock, indirect contact

WARNING

Electric shock



- Death or serious personal injury
- Connect the motor to a protective ground and provide protection against indirect contact in accordance with local regulations.

Protective-ground conductors must always have a yellow/green (PE) or yellow/green/blue (PEN) color marking.

Protection against power supply voltage transients

The motor is protected against power supply voltage transients in accordance with EN 61800-3.

Motor protection

The motor requires no external motor protection. The motor incorporates thermal protection against slow overloading and blocking.

6.2 Cable requirements

Cable cross-section

DANGER

Electric shock

Death or serious personal injury



- Always comply with local regulations as to cable cross-sections.

Single-phase supply

Conductor type	Conductor material	Cross section	
		[mm ²]	[AWG]
Solid	Copper	0.5 - 2.5	28-12
Stranded		0.5 - 2.5	30-12

Three-phase supply

Conductor type	Conductor material	Cross section	
		[mm ²]	[AWG]
Solid	Copper	0.5 - 10	18-8
Stranded		0.5 - 10	18-8

Conductors

Type

Stranded or solid copper conductors.

Temperature rating

Temperature rating for conductor insulation: 140 °F (60 °C).

Temperature rating for outer cable sheath: 167 °F (75 °C).

6.3 Power supply

DANGER



Electric shock

- Death or serious personal injury
- Use the recommended fuse size. See the section on supply voltage.

Single-phase supply voltage

- 1 × 200-240 V -10 % / +10 %, 50/60 Hz, PE.

Check that the supply voltage and frequency correspond to the values stated on the nameplate.



If you want to supply the motor through an IT network, make sure that you have a suitable motor variant. If you are in doubt, contact Grundfos.

The wires in the motor terminal box must be as short as possible. Excepted from this is the separated ground conductor which must be so long that it is the last one to be disconnected in case the cable is inadvertently pulled out of the cable entry.

For maximum backup fuse, see the section on supply voltage.

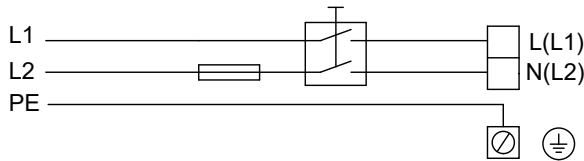

TM083397

Example of a power supply-connected motor with power supply switch and backup fuse

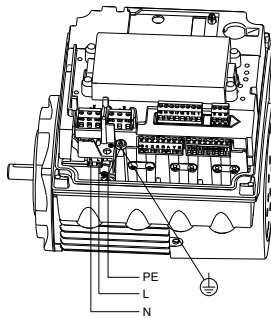

TM053494

Power supply connection, single-phase motors

Terminal L of the motor is the input for L1. Terminal N of the motor is the input of L2.

Three-phase supply voltage

- 3 × 440-480 V -10 % / +10 %, 50/60 Hz, PE
- 3 × 200-240 V -10 % / +10 %, 50/60 Hz, PE.

Check that the supply voltage and frequency correspond to the values stated on the nameplate.

The wires in the motor terminal box must be as short as possible. Excepted from this is the separated ground conductor which must be so long that it is the last one to be disconnected in case the cable is inadvertently pulled out of the cable entry.

In order to avoid loose connections, make sure that you have pressed home the terminal block for L1, L2 and L3 in its socket when you connect the supply cable.

For maximum backup fuse, see the section on supply voltage.



If you want to supply the motor through an IT network, make sure that you have a suitable motor variant. If you are in doubt, contact Grundfos.



Corner grounding is not allowed for supply voltages above 3 × 480 V, 50/60 Hz.

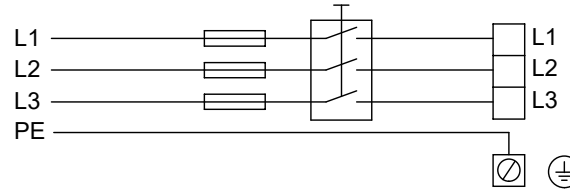

TM083398

Example of a power supply-connected motor with power supply switch and backup fuses

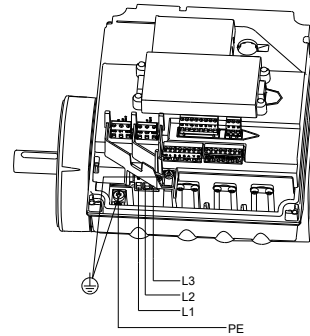

TM053495

Power supply connection, three-phase motors

Related information

[11.3.1 Supply voltage](#)

[11.4.1 Supply voltage](#)

6.4 Additional protection

The total leakage current of all the electrical equipment in the installation must be taken into account. You can find the leakage current of the motor in the sections on leakage current and leakage current (AC).

This product can cause a direct current in the protective ground conductor.

Overvoltage and undervoltage protection

Overvoltage and undervoltage may occur in case of unstable power supply or a faulty installation. The motor is stopped if the voltage falls outside the permissible voltage range. The motor restarts automatically when the voltage is again within the permissible voltage range. Therefore, no additional protection relay is required.



The motor is protected against transients from the power supply according to EN 61800-3. In areas with high lightning intensity, we recommend external lightning protection.

Overload protection

If the upper load limit is exceeded, the motor automatically compensates for this by reducing the speed and stops if the overload condition persists.

The motor remains stopped for a set period. After this period, the motor automatically attempts to restart. The overload protection prevents damage to the motor. Consequently, no additional motor protection is required.

Overtemperature protection

The electronic unit has a built-in temperature sensor as an additional protection. When the temperature rises above a certain level, the motor automatically compensates for this by reducing the speed and stops if the temperature keeps rising. The motor remains stopped for a set period. After this period, the motor automatically attempts to restart.

Protection against phase unbalance

Three-phase motors must be connected to a power supply with a quality corresponding to IEC 60146-1-1, class C, to ensure correct motor operation at phase unbalance. This also ensures long life of the components.

Related information

[11.3.2 Leakage current](#)

[11.4.2 Leakage current \(AC\)](#)

6.5 Connection terminals

The descriptions and terminal overviews in this section apply to both single- and three-phase motors.

For maximum torques, see the section on torques.

Connection terminals, CRE, CRIE, CRNE, CRKE, SPKE, MTRE and CME pumps

CRE, CRIE, CRNE, CRKE, SPKE, MTRE and CME pumps have a number of inputs and outputs enabling the pumps to be used in advanced applications where many inputs and outputs are required.

The pumps have these connections:

- three analog inputs
- one analog output
- two dedicated digital inputs
- two configurable digital inputs or open-collector outputs
- Grundfos Digital Sensor input and output
- two Pt100/1000 inputs
- two LiqTec sensor inputs
- two signal relay outputs
- GENIbus connection.

See fig. Connection terminals, CRE, CRIE, CRNE, CRKE, SPKE, MTRE and CME pumps.



Digital input 1 is factory-set to be start-stop input where open circuit results in stop. A jumper has been factory-fitted between terminals 2 and 6. Remove the jumper if digital input 1 is to be used as external start-stop or any other external function.

DANGER

Electric shock

Death or serious personal injury



- Make sure that the wires to be connected to the connection groups below are separated from each other by reinforced insulation in their entire lengths.

- Inputs and outputs

All inputs and outputs are internally separated from the power supply-conducting parts by reinforced insulation and galvanically separated from other circuits. All control terminals are supplied by protective extra-low voltage (PELV), thus ensuring protection against electric shock.

- Start-stop: (Digital input 1) = Terminals 2 and 6
- Pressure sensor: (Analog input 1) = Terminals 4 and 8
- Pressure switch: (Digital input 3) = Terminals 6 and 10
- External analog signal input: (Analog input 2) = Terminals 7 and 23
- GENIbus Terminals A, Y and B
- Signal relay outputs
 - Signal relay 1: LIVE: You can connect supply voltages up to 250 VAC. PELV: The output is galvanically separated from other circuits. Therefore, you can connect the supply voltage or protective extra-low voltage to the output as desired.
 - Signal relay 2: PELV: The output is galvanically separated from other circuits. Therefore, you can connect the supply voltage or protective extra-low voltage to the output as desired.
- Power supply (terminals N, PE, L or L1, L2, L3, PE).

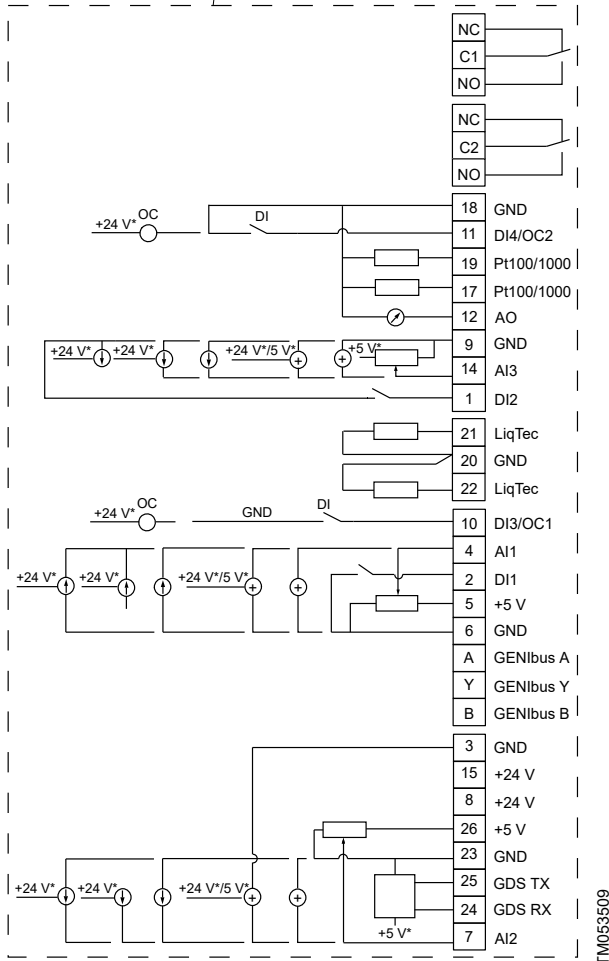
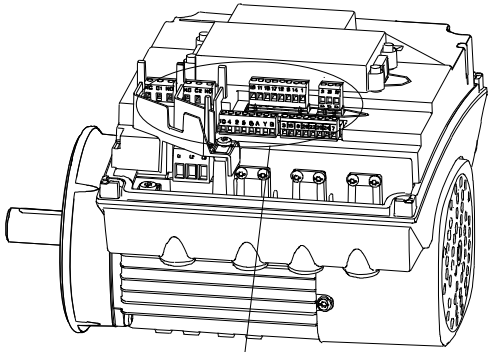

TM053509

* If you use an external supply source, there must be a connection to GND.

Connection terminals, CRE, CRIE, CRNE, CRKE, SPKE, MTR and CME pumps

Terminal	Type	Function
NC	Normally closed contact	Signal relay 1 (LIVE or PELV)
C1	Common	
NO	Normally open contact	
NC	Normally closed contact	Signal relay 2 (PELV only)
C2	Common	
NO	Normally open contact	

Terminal	Type	Function
18	GND	Ground
110.5 - 3.5 V / 0-5 V / 0-10 V	DI4/OC2	Digital input/output, configurable. Open collector: Max. 24 V resistive or inductive.
19	Pt100/1000 input 2	Pt100/1000 sensor input
17	Pt100/1000 input 1	Pt100/1000 sensor input
12	AO	Analog output: 0-20 mA / 4-20 mA 0-10 V
9	GND	Ground
14	AI3	Analog input: 0-20 mA / 4-20 mA 0-10 V
1	DI2	Digital input, configurable
21	LiqTec sensor input 1	LiqTec sensor input (white conductor)
20	GND	Ground (brown and black conductors)
22	LiqTec sensor input 2	LiqTec sensor input (blue conductor)
10	DI3/OC1	Digital input/output, configurable. Open collector: Max. 24 V resistive or inductive.
4	AI1	Analog input: 0-20 mA / 4-20 mA 0.5 - 3.5 V / 0-5 V / 0-10 V
2	DI1	Digital input, configurable
5	+5 V	Supply to potentiometer and sensor
6	GND	Ground
A	GENibus, A	GENibus, A (+)
Y	GENibus, Y	GENibus, GND
B	GENibus, B	GENibus, B (-)
3	GND	Ground
15	+24 V	Supply
8	+24 V	Supply
26	+5 V	Supply to potentiometer and sensor
23	GND	Ground
25	GDS TX	Grundfos Digital Sensor output
24	GDS RX	Grundfos Digital Sensor input
7	AI2	Analog input: 0-20 mA / 4-20 mA 0.5 - 3.5 V / 0-5 V / 0-10 V

Connection terminals, CME pumps manufactured prior to October 1, 2017

This information is optional for CRE, CRIE, CRNE, CME, SPKE and MTR pumps.

CME pumps manufactured before October 1, 2017 have these connections:

- two analog inputs
- two digital inputs or one digital input and one open-collector output
- Grundfos Digital Sensor input and output
- two signal relay outputs
- GENIbus connection.

See fig. Connection terminals, optional for CRE, CRIE, CRNE, CRKE, SPKE, MTRE and CME pumps.

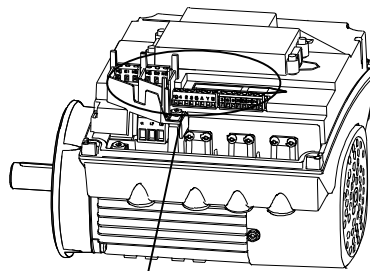

Digital input 1 is factory-set to be start-stop input where open circuit results in stop. A jumper has been factory-fitted between terminals 2 and 6. Remove the jumper if digital input 1 is to be used as external start-stop or any other external function.

DANGER

Electric shock

Death or serious personal injury



- Make sure that the wires to be connected to the connection groups below are separated from each other by reinforced insulation in their entire lengths.

Inputs and outputs

All inputs and outputs are internally separated from the power supply-conducting parts by reinforced insulation and galvanically separated from other circuits. All control terminals are supplied by protective extra-low voltage (PELV), thus ensuring protection against electric shock.

- Start-stop: (Digital input 1) = Terminals 2 and 6
- Pressure sensor: (Analog input 1) = Terminals 4 and 8
- Pressure switch: (Digital input 3) = Terminals 6 and 10
- External analog signal input: (Analog input 2) = Terminals 7 and 23

GENIbus Terminals A, Y and B

Signal relay outputs

- Signal relay 1:

LIVE:

You can connect supply voltages up to 250 VAC to the output.

PELV:

The output is galvanically separated from other circuits.

Therefore, you can connect the supply voltage or protective extra-low voltage to the output as desired.

- Signal relay 2:

PELV:

The output is galvanically separated from other circuits.

Therefore, you can connect the supply voltage or protective extra-low voltage to the output as desired.

- Power supply (terminals N, PE, L or L1, L2, L3, PE).

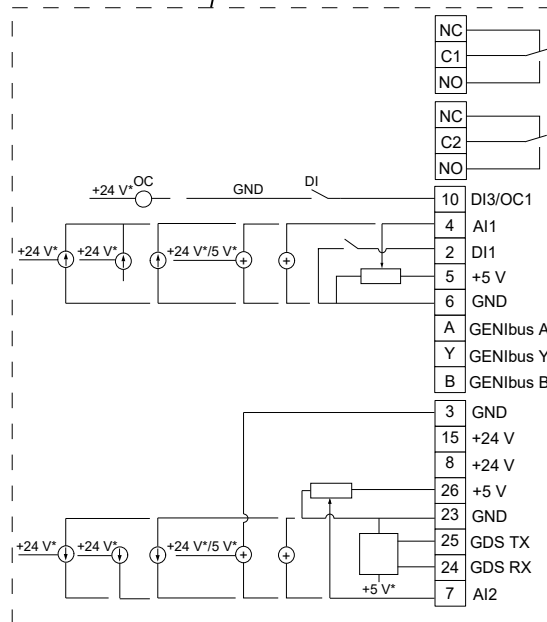

TM053510

* If you use an external supply source, there must be a connection to GND.

Connection terminals, optional for CRE, CRIE, CRNE, CRKE, SPKE, MTRE and CME pumps

Terminal	Type	Function
NC	Normally closed contact	Signal relay 1 (LIVE or PELV)
C1	Common	
NO	Normally open contact	
NC	Normally closed contact	Signal relay 2 (PELV only)
C2	Common	
NO	Normally open contact	
10	DI3/OC1	Digital input/output, configurable. Open collector: Max. 24 V resistive or inductive.
4	AI1	Analog input: 0-20 mA / 4-20 mA 0.5 - 3.5 V / 0-5 V / 0-10 V
2	DI1	Digital input, configurable
5	+5 V	Supply to potentiometer and sensor
6	GND	Ground
A	GENIbus, A	GENIbus, A (+)

Terminal	Type	Function
Y	GENIbus, Y	GENIbus, GND
B	GENIbus, B	GENIbus, B (-)
3	GND	Ground
15	+24 V	Supply
8	+24 V	Supply
26	+5 V	Supply to potentiometer and sensor
23	GND	Ground
25	GDS TX	Grundfos Digital Sensor output
24	GDS RX	Grundfos Digital Sensor input
7	AI2	Analog input: 0-20 mA / 4-20 mA 0.5 - 3.5 V / 0-5 V / 0-10 V

Related information

11.6 Other technical data

6.6 Signal cables

- Use screened cables with a cross-sectional area of minimum 28 AWG and maximum 16 AWG for the external on/off switch, digital inputs and setpoint signals.
- Connect the screens of the cables to the frame at both ends with good connection. The screens must be as close as possible to the terminals. See the figure below.

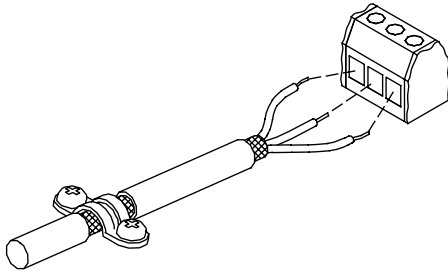

Stripped cable with screen and wire connections

- Always tighten screws for frame connections whether a cable is fitted or not.
- The wires in the motor terminal box must be as short as possible.

Connection of Danfoss pressure sensor MBS3000 to E-pump



MBS3000 pressure sensor

Use screened cables with a cross-sectional area of minimum 28 AWG and maximum 16 AWG.

The blue wire of the pressure sensor is connected to the #4 terminal of the E-pump. The brown wire of the pressure sensor is connected to the #8 terminal of the E-pump.

Connection of Grundfos pressure sensor ISP44 to E-pump



ISP44 pressure sensor

Use unscreened cables with a cross-sectional area of minimum 28 AWG and maximum 16 AWG.

The blue wire of the pressure sensor is connected to the #4 terminal of the E-pump. The brown wire of the pressure sensor is connected to the #8 terminal of the E-pump.

6.7 Bus connection cable

New installations

For the bus connection, use a screened 3-core cable with a cross-sectional area of minimum 28 AWG and maximum 16 AWG.

If the motor is connected to a unit with a cable clamp which is identical to the one on the motor, connect the screen to this cable clamp.

If the unit has no cable clamp leave the screen unconnected at this end. See the figure below.

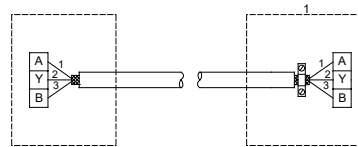

Connection with screened 3-core cable

Pos.	Description
1	Motor

Replacing a motor

- If a 2-core cable is used in the installation, connect it as shown in the figure below.

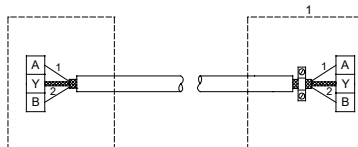

Connection with screened 2-core cable

Pos.	Description
1	Motor

- If a screened 3-core cable is used in the installation, follow the instructions in the section on the new installations above.

6.8 Installing a communication interface module

DANGER

Electric shock



Death or serious personal injury

- Switch off the power supply to the motor and to the signal relays. Wait at least 5 minutes before starting any work on the motor. Make sure that the power supply cannot be accidentally switched on.



Always use an antistatic service kit when handling electronic components. This prevents static electricity from damaging the components.

When unprotected, place the component on the antistatic cloth.

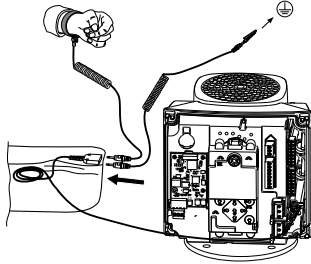

Antistatic service kit

1. Loosen the four screws (figure below, A) and remove the terminal box cover (B).

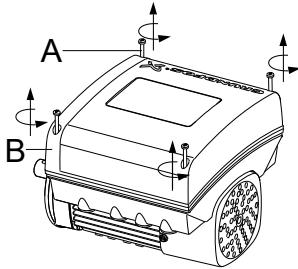

Removing the terminal box cover

2. Remove the CIM cover (figure below, A) by pressing the locking tab (B) and lifting the end of the cover (C). Then lift the cover off the hooks (D).

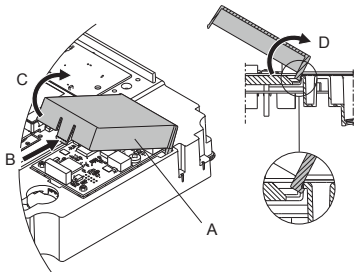

Removing the CIM cover

3. Remove the securing screw (figure below, A).

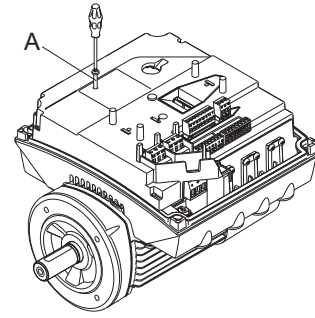

Removing the securing screw

4. Fit the CIM module by aligning it with the three plastic holders (figure below, A) and the connecting plug (B). Press home the module using your fingers.

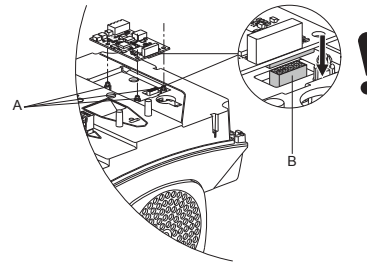

Fitting the CIM module

5. Fit and tighten securing screw (figure Removing the securing screw, A) to 1.3 Nm.
6. Make the electrical connections to the CIM module as described in the instructions delivered with the module.
7. Connect the cable screens of the bus cables to ground via one of the ground clamps (figure below, A).

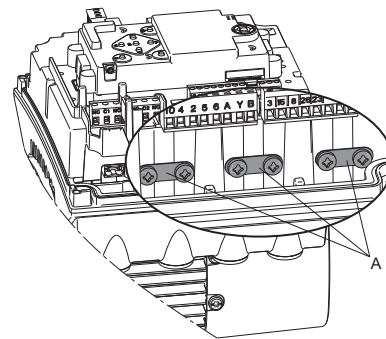

Connecting the cable screens to ground

TM064462

TM064081

TM064084

TM064082

TM064083

TM064195

8. Route the wires for the CIM module. See the example in the figure below.

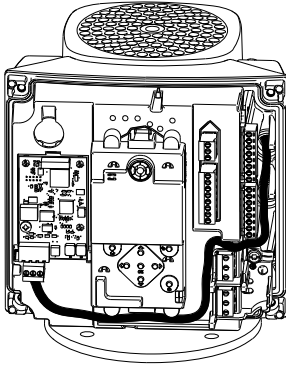

TM064085

Example of wire routing

9. Fit the CIM cover.
10. If the CIM module is supplied with an FCC label, then place this on the terminal box. See the figure below.

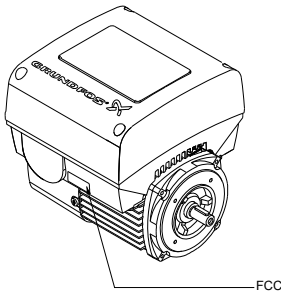

TM057028

FCC label

11. Fit the terminal box cover (figure Removing the terminal box cover above, B) and cross-tighten the four mounting screws (A) to 6 Nm.



Make sure that the terminal box cover is aligned with the operating panel. See the section on changing the position of the operating panel.

Related information

[5.8 Changing the position of the control \(operating\) panel](#)

7. User interfaces

WARNING



Hot surface

Death or serious personal injury

- Only touch the buttons on the display as the product may be very hot.

You can make the pump settings by means of the following user interfaces:

Operating panels

- Standard operating panel. See the section on the standard operating panel.
- Advanced operating panel. See the section on the advanced operating panel.

Remote controls

- Grundfos GO Remote. See the section on Grundfos GO Remote.
- Grundfos R100 remote control. See the section on R100 remote control.

If the power supply to the pump is switched off, the settings are stored.

Related information

- [7.1 Standard operating panel](#)
- [7.2 Advanced operating panel](#)
- [7.3 Grundfos GO Remote](#)
- [7.4 R100 remote control](#)

7.1 Standard operating panel

The pumps are fitted with this operating panel as standard.

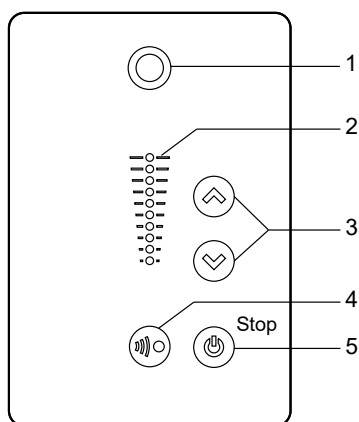

TM054848

Standard operating panel

Pos.	Symbol	Description
1		Grundfos Eye It shows the operating status of the pump. For further information, see the section on changing the position of the operating panel.
2	-	Light fields for indication of setpoint.
3		Up and down. They change the setpoint.
4		It allows radio communication with Grundfos GO Remote and other products of the same type. When you try to establish radio communication between the pump and Grundfos GO Remote or another pump, the green indicator light in Grundfos Eye on the pump flashes continuously. Press on the pump operating panel to allow radio communication with Grundfos GO Remote and other products of the same type.
5		It makes the pump ready for operation or starts and stops the pump. Start If you press the button when the pump is stopped, the pump only starts if no other functions with higher priority have been enabled. See the section on the description of settings. Stop If you press the button when the pump is running, the pump always stops. The "Stop" text next to the button is on.

Related information

[5.8 Changing the position of the control \(operating\) panel](#)

[9.1 Priority of settings](#)

7.1.1 Setpoint setting

Set the desired setpoint of the pump by pressing \odot or \ominus . The green light fields on the operating panel indicate the setpoint set.

Pump in constant-pressure control mode

The following example applies to a pump in an application where a pressure sensor gives a feedback to the pump. If the sensor is retrofitted to the pump, you must set it up manually as the pump does not automatically register a connected sensor. See the section on analog inputs.

The figure below shows that the light fields 5 and 6 are activated, indicating a desired setpoint of 116 psi (3 bar) with a sensor measuring range from 0 to 232 psi (6 bar). The setting range is equal to the sensor measuring range.

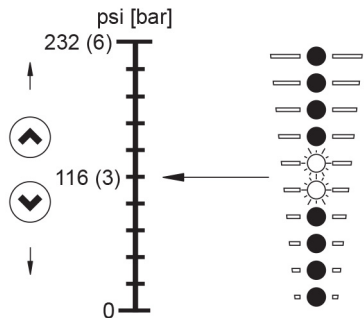

Setpoint set to 116 psi (3 bar), constant pressure control

Pump in constant-curve control mode

In constant-curve control mode, the pump performance lies between the maximum and minimum curve of the pump. See the figure below.

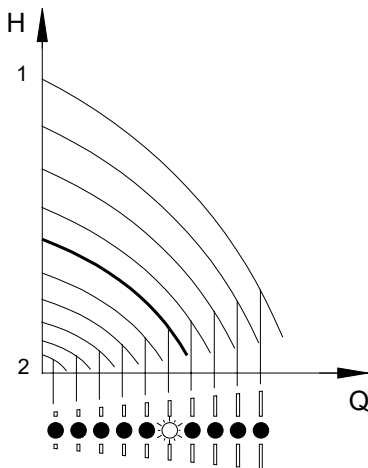

Pump in constant-curve control mode

Pos.	Description
1	Max.
2	Min.

Setting to maximum curve:

- Press \odot continuously to change over to the maximum curve of the pump (top light field flashes). When the top light field is on, press \odot for 3 seconds until the light field starts flashing.
- To go back, press \ominus continuously until the desired setpoint is indicated.

Example: Pump set to maximum curve.

The figure below shows that the top light field is flashing, indicating the maximum curve.

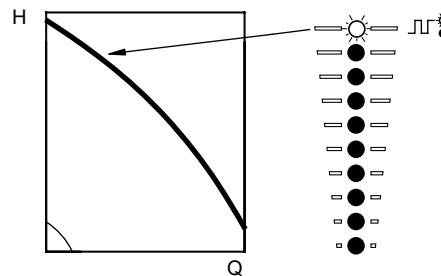

Maximum curve duty

Setting to minimum curve:

- Press \ominus continuously to change over to the minimum curve of the pump (bottom light field flashes). When the bottom light field is on, press \ominus for 3 seconds until the light field starts flashing.
- To go back, press \odot continuously until the desired setpoint is indicated.

Example: Pump set to minimum curve.

The figure below shows that the bottom light field is flashing, indicating the minimum curve.

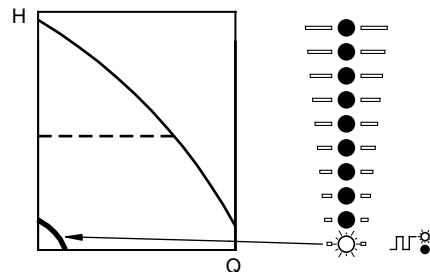

Minimum curve duty

Start-stop of pump



If you have stopped the pump by pressing \odot and the "Stop" text on the operating panel is illuminated, you can only give it free to operation by pressing \odot again.

If you have stopped the pump by pressing \ominus , you can restart it by pressing \odot or by using Grundfos GO Remote.

Start the pump by pressing \odot or by continuously pressing \odot until the desired setpoint is indicated.

Stop the pump by pressing \odot . When the pump is stopped, the "Stop" text next to the button is on. You can also stop the pump by continuously pressing \ominus until none of the light fields are on. You can also stop the pump with Grundfos GO Remote or via a digital input set to "External stop". See the section on the description of settings.

Resetting of fault indications

You can reset a fault indication in one of the following ways:

- Via the digital input if you have set it to "Alarm resetting".
- Briefly press \odot or \ominus on the pump. This does not change the setting of the pump. You cannot reset a fault indication by pressing \odot or \ominus if the buttons have been locked.
- Switch off the power supply until the indicator lights are off.
- Switch the external start-stop input off and then on again.
- With Grundfos GO Remote.

TM068914

TM054895

TM054896

TM054897

Related information

- [8.5 "Analog inputs"](#)
- [9.1 Priority of settings](#)

7.2 Advanced operating panel

The pumps can be fitted with the advanced operating panel as an option.

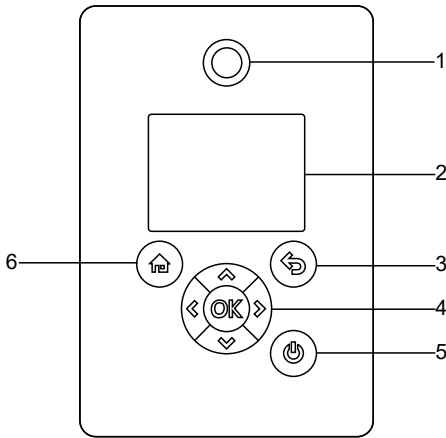

Advanced operating panel

TM054849

Pos.	Symbol	Description
1		Grundfos Eye This shows the operating status of the pump. For further information, see the section on changing the position of the operating panel.
2	-	Graphical color display.
3		It goes one step back.
		With these buttons you can navigate between main menus, displays and digits. When you change the menu, the display always shows the top display of the new menu.
		With these buttons you can navigate between submenus. They change value settings.
		Note: If you have disabled the possibility to make settings with the "Enable/disable settings" function, then you can enable it again temporarily by pressing these buttons simultaneously for at least 5 seconds. See the section on the buttons on the product ("enable/disable settings").
4		It saves changed values, resets alarms and expands the value field. It enables radio communication with Grundfos GO Remote and other products of the same type. When you try to establish radio communication between the pump and Grundfos GO Remote or another pump, the green indicator light in Grundfos Eye flashes. A note also appears in the pump display stating that a wireless device wants to connect to the pump. Press OK on the pump operating panel to allow radio communication with Grundfos GO Remote and other products of the same type.
		This makes the pump ready for operation/starts and stops the pump. Start: If you press the button when the pump is stopped, the pump only starts if no other functions with higher priority have been enabled. See the section on the description of settings. Stop: If you press the button when the pump is running, the pump is always stopped. When you stop the pump via this button, the icon appears in the bottom of the display.
5		
6		This button goes to the "Home" menu.

Related information

- [5.8 Changing the position of the control \(operating\) panel](#)
- [8.29 "Buttons on product" \("Enable/disable settings"\)](#)
- [9.1 Priority of settings](#)

7.2.1 Home display

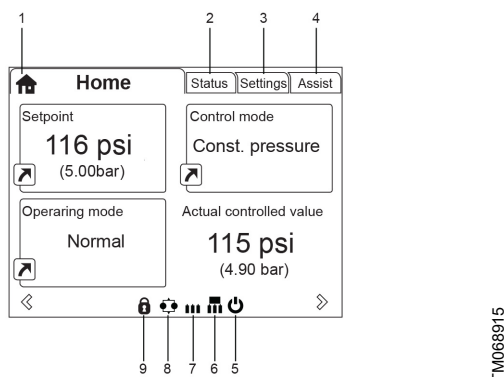

TM068915

Example of "Home" display

Pos.	Symbol	Description
1		"Home" This menu shows up to four user-defined parameters. You can select parameters shown as shortcut icon , and when pressing OK you go directly to the "Settings" display for the selected parameter.
2	-	"Status" This menu shows the status of the pump and system as well as warnings and alarms.
3	-	"Settings" This menu gives access to all setting parameters. You can make detailed settings of the pump in this menu. See the section on the description of functions.
4	-	"Assist" This menu enables assisted pump setup, provides a short description of the control modes and offers fault advice. See the section on "assist".
5		This symbol indicates that the pump has been stopped via the button.
6		This symbol indicates that the pump is functioning as master pump in a multipump system.
7		This symbol indicates that the pump is functioning as a slave pump in a multipump system.
8		This symbol indicates that the pump is operating in a multipump system. See the section on setting up a multi-pump system.
9		This symbol indicates that the possibility to make settings has been disabled for protective reasons. See the section on the buttons on the product ("enable/disable settings").

Related information

[8.1 "Setpoint"](#)

[8.29 "Buttons on product" \("Enable/disable settings"\)](#)

[8.40 "Assist"](#)

[8.44 "Multi-pump setup" \("Setup of multi-pump system"\)](#)

7.2.2 Startup guide

The pump incorporates a startup guide which is started at the first startup. See the section on running the startup guide. After the startup guide, the main menus appear in the display.

Related information

[8.37 "Run start-up guide"](#)

[8.37 Consultez guide de démarrage](#)

[8.37 "Ejecutar guía de config. inicial"](#)

7.2.3 Menu overview for advanced operating panel

"Home"

"Home"	CRE, CRIE, CRNE, CRKE, SPKE, MTRE	CME	Multipump system
	•	•	•

"Status"

"Status"	CRE, CRIE, CRNE, CRKE, SPKE, MTRE	CME	Multipump system
"Operating status"	•	•	•
"Operating mode, from"	•	•	•
"Control mode"	•	•	•
"Pump performance"	•	•	•
"Actual controlled value"	•	•	•
"Resulting setpoint"	•	•	•
"Speed"	•	•	•
"Acc. flow and specific energy"	•	•	•
"Power and energy consumption"	•	•	•
"Measured values"	•	•	•
"Analog input 1"	•	•	•
"Analog input 2"	•	•	•
"Analog input 3"	•	•	• ¹⁾
"Pt100/1000 input 1"	•	•	• ¹⁾
"Pt100/1000 input 2"	•	•	• ¹⁾
"Analog output"	•	•	• ¹⁾
"Warning and alarm"	•	•	•
"Actual warning or alarm"	•	•	•
"Warning log"	•	•	•
"Alarm log"	•	•	•
"Operating log"	•	•	•
"Operating hours"	•	•	•
"Module type"	•	•	•
"Date and time"	•	•	•
"Product identification"	•	•	•
"Motor bearing monitoring"	•	•	•
"Multi-pump system"			•
"System operating status"			•
"System performance"			•
"System input power and energy"			•
"Pump 1, multi-pump system"			•
"Pump 2, multi-pump system"			•
"Pump 3, multi-pump system"			•
"Pump 4, multi-pump system"			•

1) Only available if an advanced functional module, type FM 300, is fitted.

"Settings"

"Settings"	CRE, CRIE, CRNE, CRKE, SPKE, MTRÉ	CME	Multipump system
<i>"Setpoint"</i>	•	•	•
<i>"Operating mode"</i>	•	•	•
<i>"Set manual speed"</i>	•	•	•
<i>"Control mode"</i>	•	•	•
<i>"Analog inputs"</i>	•	•	•
"Analog input 1, setup"	•	•	•
"Analog input 2, setup"	•	•	•
"Analog input 3, setup"	•	•	• ¹⁾
<i>"Pt100/1000 inputs"</i>	•	•	• ¹⁾
"Pt100/1000 input 1,setup"	•	•	• ¹⁾
"Pt100/1000 input 2,setup"	•	•	• ¹⁾
<i>"Digital inputs"</i>	•	•	•
"Digital input 1, setup"	•	•	•
"Digital input 2, setup"	•	•	• ¹⁾
<i>"Digital inputs/outputs"</i>	•	•	•
"Digital input/output 3, setup"	•	•	•
"Digital input/output 4, setup"	•	•	• ¹⁾
<i>"Signal relays" 1 and 2 ("Relay outputs")</i>	•	•	•
"Relay output 1"	•	•	•
"Relay output 2"	•	•	•
<i>"Analog output"</i>	•	•	• ¹⁾
"Output signal"	•	•	• ¹⁾
"Function of analog output"	•	•	• ¹⁾
<i>"Controller" ("Controller settings")</i>	•	•	•
<i>"Operating range"</i>	•	•	•
"Setpoint influence"	•	•	•
<i>"External setpoint function"</i>	•	•	•
<i>"Predefined setpoints"</i>	•	•	• ¹⁾
"Monitoring functions"	•	•	•
<i>"Motor bearing monitoring"</i>	•	•	•
<i>"Bearings replaced" ("Motor bearing maintenance")</i>	•	•	•
<i>"Limit-exceeded function"</i>	•	•	•
<i>"LiqTec" ("Liq Tec function")</i>	•	•	•
"Special functions"	•	•	•
<i>"Stop function" ("Low-flow stop function")</i>	•	•	•
<i>"Pipe filling function"</i>	•	•	•
<i>"Pulse flowmeter" ("Pulse flowmeter setup")</i>	•	•	•
<i>"Ramps"</i>	•	•	•
<i>"Standstill heating"</i>	•	•	•
"Communication"	•	•	•
<i>"Number" ("Pump number")</i>	•	•	•
<i>"Radio communication" ("Enable/disable radio comm.")</i>	•	•	•
"General settings"	•	•	•
<i>"Language"</i>	•	•	•
<i>"Date and time" ("Set date and time")</i>	•	•	•
<i>"Unit configuration" ("Units")</i>	•	•	•
<i>"Buttons on product" ("Enable/disable settings")</i>	•	•	•

"Settings"	CRE, CRIE, CRNE, CRKE, SPKE, MTR	CME	Multipump system
<i>"Delete history"</i>	•	•	•
<i>"Define Home display"</i>	•	•	•
<i>"Display settings"</i>	•	•	•
<i>"Store settings" ("Store actual settings")</i>	•	•	•
<i>"Recall settings" ("Recall stored settings")</i>	•	•	•
<i>"Run start-up guide"</i>	•	•	•

1) Only available if an advanced functional module, type FM 300, is fitted.

"Assist"

"Assist"	CRE, CRIE, CRNE, CRKE, SPKE, MTR	CME	Multipump system
<i>"Assisted pump setup"</i>	•	•	•
<i>"Setup, analog input"</i>	•	•	•
<i>"Setting of date and time"</i>	•	•	•
<i>"Multi-pump setup" ("Setup of multi-pump system")</i>	•	•	•
<i>"Description of control mode"</i>	•	•	•
<i>"Assisted fault advice"</i>	•	•	•

7.3 Grundfos GO Remote

The product is designed for wireless radio or infrared communication with Grundfos GO Remote.

Grundfos GO Remote enables you to set functions and gives you access to status overviews, technical product information and current operating parameters.

Use Grundfos GO Remote together with this mobile interface:

- Grundfos MI 301.

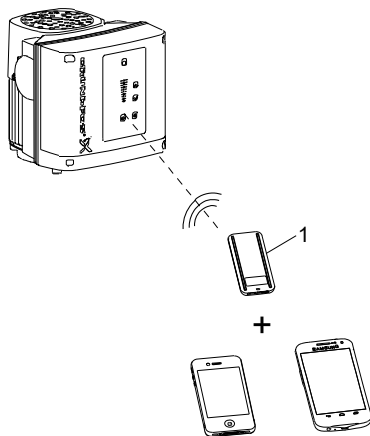

TMO66256

Pos.	Description
1	Grundfos MI 301: Separate module enabling radio or infrared communication. Use the module together with an Android or iOS-based smart device via a Bluetooth connection.

7.3.1 Communication

When Grundfos GO Remote initiates communication with the pump, the indicator light in the middle of Grundfos Eye flashes green. See the section on changing the position of the operating panel.

Furthermore, on pumps fitted with an advanced operating panel a text appears in the display saying that a wireless device is trying to establish connection. Press **OK** on the pump in order to establish connection with Grundfos GO Remote or press **⬆** to reject connection.

Establish communication using one of these communication types:

- radio communication
- infrared communication.

Radio communication

Radio communication can take place at distances up to 30 meters. The first time Grundfos GO Remote communicates with the pump, you must enable communication by pressing **Ⓜ** or **OK** on the pump operating panel. Later when communication takes place, the pump is recognized by Grundfos GO Remote and you can select the pump from the "List" menu.

Infrared communication

When communicating via infrared light, Grundfos GO Remote must be pointed at the pump operating panel.

Related information

[5.8 Changing the position of the control \(operating\) panel](#)

7.3.2 Menu overview for Grundfos GO Remote

Dashboard	CRE, CRIE, CRNE, CRKE, SPKE, MTRE	CME	Multipump system
	•	•	•
"Status"	CRE, CRIE, CRNE, CRKE, SPKE, MTRE	CME	Multipump system
"System mode"			• ¹⁾
"Resulting setpoint"	•	•	
"Resulting system setpoint"			• ¹⁾
"Actual controlled value"	•	•	• ¹⁾
"Motor speed"	•	•	
"Power consumption"	•	•	
"Power cons., sys."			• ¹⁾
"Energy consumption"	•	•	
"Energy cons., sys."			• ¹⁾
"Acc. flow, specific energy"	•	•	• ¹⁾
"Operating hours"	•	•	
"Operating hours, system"			• ¹⁾
"Pt100/1000 input 1"	•	•	
"Pt100/1000 input 2"	•	•	
"Analog output"	•	•	
"Analog input 1"	•	•	
"Analog input 2"	•	•	
"Analog input 3"	•	•	
"Digital input 1"	•	•	
"Digital input 2"	•	•	
"Digital in/output 3"	•	•	
"Digital in/output 4"	•	•	
"Fitted modules"	•	•	
"Pump 1"			• ¹⁾
"Pump 2"			• ¹⁾
"Pump 3"			• ¹⁾
"Pump 4"			• ¹⁾

1) Only available if Grundfos GO Remote is connected to a multipump system.

"Settings"	CRE, CRIE, CRNE, CRKE, SPKE, MTRE	CME	Multipump system
"Setpoint"	•	•	•
"Operating mode"	•	•	•
"Control mode"	•	•	•
"Pipe filling function"	•	•	•
"Buttons on product" ("Enable/disable settings")	•	•	
"LiqTec" ("LiqTec function")	•	•	
"Stop function" ("Low-flow stop function")	•	•	•
"Controller" ("Controller settings")	•	•	•
"Operating range"	•	•	•
"Ramps"	•	•	
"Number" ("Pump number")	•	•	
"Radio communication" ("Enable/disable radio comm.")	•	•	
"Analog inputs"			
"Analog input 1"	•	•	
"Analog input 2"	•	•	
"Analog input 3"	•	•	
"Pt100/1000 inputs"			
"Pt100/1000 input 1"	•	•	
"Pt100/1000 input 2"	•	•	
"Digital inputs"			
"Digital input 1"	•	•	
"Digital input 2"	•	•	
"Digital inputs/outputs"			
"Digital in/output 3"	•	•	
"Digital in/output 4"	•	•	
"Pulse flowmeter" ("Pulse flowmeter setup")	•	•	
"Predefined setpoints"	•	•	•
"Analog output"	•	•	
"External setpoint function"	•	•	
"Signal relays" 1 and 2 ("Relay outputs")			
"Signal relay 1"	•	•	
"Signal relay 2"	•	•	
"Limit-exceeded function"			
"Limit 1 exceeded"	•	•	•
"Limit 2 exceeded"	•	•	•
"Multi-pump setup" ("Setup of multi-pump system")			
"Alternating operation, time"			• ¹⁾
"Time for pump changeover"			• ^{1) + 2)}
"Standstill heating"	•	•	
"Motor bearing monitoring"	•	•	
"Service"	•	•	
"Date and time" ("Set date and time")	•	•	
"Store settings" ("Store actual settings")	•	•	
"Recall settings" ("Recall stored settings")	•	•	
"Undo"	•	•	•
"Pump name"	•	•	•
"Connection code"	•	•	•
"Unit configuration" ("Units")	•	•	

1) Only available if Grundfos GO Remote is connected to a multipump system.

²⁾ Only available if an advanced functional module, type FM 300, is fitted.

"Alarms and warnings"	CRE, CRIE, CRNE, CRKE, SPKE, MTR	CME	Multipump system
<i>"Alarm log"</i>	•	•	•
<i>"Warning log"</i>	•	•	•
"Reset alarm" button	•	•	•

"Assist"	CRE, CRIE, CRNE, CRKE, SPKE, MTR	CME	Multipump system
<i>"Assisted pump setup"</i>	•	•	
<i>"Assisted fault advice"</i>	•	•	•
<i>"Multi-pump setup" ("Setup of multi-pump system")</i>	•	•	•

7.4 R100 remote control

The pumps are designed for wireless communication with the Grundfos R100 remote control.

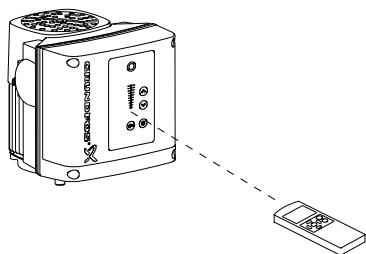

TM053933

R100 communicating with the pump via infrared light

During communication, point R100 at the operating panel. When R100 communicates with the pump, the indicator light in the middle of the Grundfos Eye flashes green. See the section on Grundfos Eye.

R100 offers additional possibilities of setting and status displays for the pump.

The displays are divided into four parallel menus:

"0. GENERAL" (see operating instructions for the R100)

"1. OPERATION"

"2. STATUS"

"3. INSTALLATION."

See the section on the menu overview for R100.

It may be necessary to update R100 to access the new menus.

Related information

[3.4 Grundfos Eye](#)

[7.4.1 Menu overview for R100](#)

7.4.1 Menu overview for R100

"General"	CRE, CRIE, CRNE, CRKE, SPKE, MTRE	CME	Multipump system
"Switch off R100"	•	•	
"Return to start"	•	•	
"Delete all changes"	•	•	
"Store settings"	•	•	
"Call up settings"	•	•	
"Store status data"	•	•	
"Call up status data"	•	•	

"Operation"	CRE, CRIE, CRNE, CRKE, SPKE, MTRE	CME	Multipump system
"Setpoint"	•	•	
"Operating mode"	•	•	
"Set manual speed"	•	•	
"Alarm"	•	•	
"Warning"	•	•	
"Alarm log"	•	•	
"Warning log"	•	•	

"Status"	CRE, CRIE, CRNE, CRKE, SPKE, MTRE	CME	Multipump system
"Actual setpoint and external setpoint"	•	•	
"Operating mode"	•	•	
"Actual controlled value"	•	•	
"Analog input 1, 2 and 3"	•	•	
"Pt100/1000 input 1 and 2"	•	•	
"Speed"	•	•	
"Power input and power consumption"	•	•	
"Operating hours"	•	•	
"Replace motor bearings"	•	•	

"Installation"	CRE, CRIE, CRNE, CRKE, SPKE, MTRE	CME	Multipump system
<i>"Control mode"</i>	•	•	
<i>"Controller" ("Controller settings")</i>	•	•	
<i>"Signal relays" 1 and 2 ("Relay outputs")</i>	•	•	
<i>"Buttons on product" ("Enable/disable settings")</i>	•	•	
<i>"Number" ("Pump number")</i>	•	•	
<i>"Digital inputs"</i>	•	•	
<i>"Digital inputs/outputs"</i>			
"Digital input/output 3 and 4, State"	•	•	
"Digital input/output 3 and 4, Function"	•	•	
<i>"Analog inputs"</i>			
"Analog input 1, 2 and 3, Function"	•	•	
"Analog input 1, 2 and 3, Measured parameter"	•	•	
"Analog input 1, 2 and 3"	•	•	
<i>"Pt100/1000 inputs"</i>			
"Pt100/1000 input 1 and 2, Function"	•	•	
"Pt100/1000 input 1 and 2, Measured parameter"	•	•	
<i>"LiqTec" ("LiqTec function")</i>	•	•	
<i>"Operating range"</i>	•	•	
<i>"Ramps"</i>	•	•	
<i>"Motor bearing monitoring"</i>	•	•	
<i>"Service"</i>	•	•	
<i>"Standstill heating"</i>	•	•	

8. Description of functions

8.1 "Setpoint"

Pump variant	"Setpoint"
CME	•
CRE, CRIE, CRNE, CRKE, SPKE, MTRE	•

You can set the setpoint for all control modes when you have selected the desired control mode. See the section on the control mode.

Factory setting

See the section on factory settings.

Related information

[8.4 "Control mode"](#)

[9.2 Factory settings](#)

8.2 "Operating mode"

Pump variant	"Operating mode"
CME	•
CRE, CRIE, CRNE, CRKE, SPKE, MTRE	•

Possible operating modes:

- "Normal"
The pump runs according to the selected control mode.
- "Stop"
The pump stops.
- "Min."
You can use the minimum curve mode in periods in which a minimum flow is required. When operating according to the minimum curve, the pump is operating like an uncontrolled pump.
- "Max."
You can use the maximum curve mode in periods in which a maximum flow is required. When operating according to the maximum curve, the pump is operating like an uncontrolled pump.
- "Manual"
The pump is operating at a manually set speed. In "Manual" the setpoint via bus is over-ruled. See the section on setting the manual speed.

All operating modes are illustrated in the figure below.

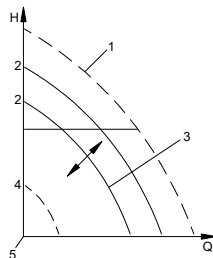

TM081111

Operating modes

Pos.	Description
1	"Max."
2	"Normal"
3	"Manual"
4	"Min."
5	"Stop"

Factory setting

See the section on factory settings.

Related information

[8.3 "Set manual speed"](#)

[9.2 Factory settings](#)

8.3 "Set manual speed"

This menu is only available in the advanced operating panel. With Grundfos GO Remote, you set the speed via the "Setpoint" menu.

You can set the pump speed in % of the maximum speed. When you have set the operating mode to "Manual", the pump runs at the set speed.

Factory setting

See the section on factory settings.

Related information

[9.2 Factory settings](#)

8.4 "Control mode"

Pump variant	"Control mode"
CME	•
CRE, CRIE, CRNE, CRKE, SPKE, MTRE	•

Possible control modes:

- "Constant pressure" ("Const. pressure")
- "Constant temperature" ("Const. temp.")
- "Constant differential pressure" ("Con. diff. press.")
- "Constant differential temperature" ("Con. diff. temp.")
- "Constant flow rate" ("Const. flow rate")
- "Constant level" ("Const. level")
- "Constant other value" ("Const. other val.")
- "Constant curve" ("Const. curve".)

Factory setting

See the section on factory settings.

Related information

[9.2 Factory settings](#)

8.4.1 "Constant pressure"

Pump variant	"Constant pressure"
CME	•
CRE, CRIE, CRNE, CRKE, SPKE, MTRE	•

We recommend this control mode if the pump is to deliver a constant pressure, independently of the flow in the system. See the figure below.

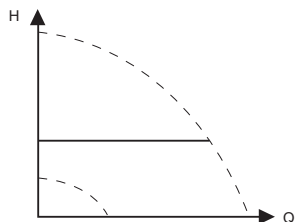

TM057901

"Constant pressure"

This control mode uses the factory-fitted pressure sensor, if any, which measures the outlet pressure of the pump.

For pumps without a factory-fitted sensor, you must connect a pressure sensor to one of the analog inputs of the pump. You can set the pressure sensor in the "Assist" menu. See the section on assisted pump setup.

Examples

- One external pressure sensor.

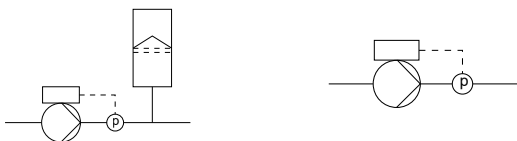

"Constant pressure"

"Controller settings"

For recommended controller settings, see the section on controller settings.

Factory setting

See the section on factory settings.

Related information

[8.11 "Controller" \("Controller settings"\)](#)

[8.41 "Assisted pump setup"](#)

[9.2 Factory settings](#)

8.4.2 "Constant temperature"

Pump variant	"Constant temperature"
CME	•
CRE, CRIE, CRNE, CRKE, SPKE, MTRE	•

This control mode ensures a constant temperature. Constant temperature is a comfort control mode that you can use in domestic hot-water systems to control the flow to maintain a fixed temperature in the system. See the figure below.

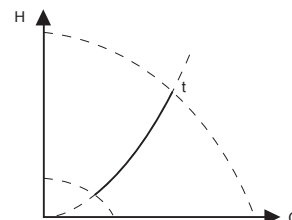

TM057900

"Constant temperature"

This control mode requires a temperature sensor placed at the location where the temperature is to be controlled. See the examples below:

Examples



"Constant temperature"

"Controller settings"

For recommended controller settings, see the section on controller settings.

Factory setting

See the section on factory settings.

Related information

[8.11 "Controller" \("Controller settings"\)](#)

[9.2 Factory settings](#)

8.4.3 "Constant differential pressure"

Pump variant	"Constant differential pressure"
CME	•
CRE, CRIE, CRNE, CRKE, SPKE, MTRE	•

The pump maintains a constant differential pressure, independently of the flow in the system. See the figure below.

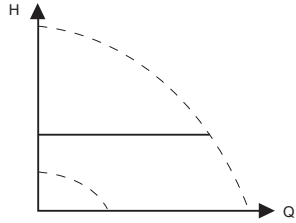

TM057901

"Constant differential pressure"

This control mode requires either a differential-pressure sensor or two external pressure sensors. See the examples below:

Examples

- One differential-pressure sensor.
The pump uses the input from the sensor to control the differential pressure.
You can set the sensor manually or by using the "Assist" menu. See the section on assisted pump setup.

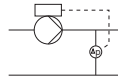
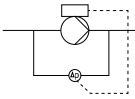

- Two pressure sensors.
Constant differential-pressure control is achievable with two pressure sensors. The pump uses the inputs from the two sensors and calculates the differential pressure.
Both sensors must have the same unit and must be set as feedback sensors. You can set the sensors manually, sensor by sensor, or by using the "Assist" menu. See the section on assisted pump setup.

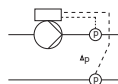
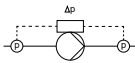

"Constant differential pressure"

"Controller settings"

For recommended controller settings, see the section on controller settings.

Factory setting

See the section on factory settings.

Related information

[8.11 "Controller" \("Controller settings"\)](#)

[8.41 "Assisted pump setup"](#)

[9.2 Factory settings](#)

8.4.4 "Constant differential temperature"

Pump variant	"Constant differential temperature"
CME	•
CRE, CRIE, CRNE, CRKE, SPKE, MTRE	•

The pump maintains a constant differential temperature in the system and the pump performance is controlled according to this. See the figure below.

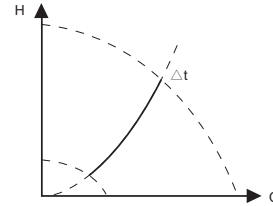

TM057954

"Constant differential temperature"

This control mode requires either two temperature sensors or one differential-temperature sensor. See the examples below. The temperature sensors can either be analog sensors connected to two of the analog inputs or two Pt100/Pt1000 sensors connected to the Pt100/1000 inputs, if these are available on the specific pump. Set the sensor in the "Assist" menu under "Assisted pump setup". See the section on assisted pump setup.

Examples

- One differential-temperature sensor.
The pump uses the input from the sensor to control the differential temperature.
You can set the sensor manually or by using the "Assist" menu. See the section on assisted pump setup.

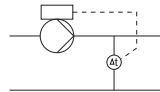

- Two temperature sensors.
Constant differential-temperature control is achievable with two temperature sensors. The pump uses the input from the two sensors and calculates the differential temperature.
Both sensors must have the same unit and must be set as feedback sensors. You can do this manually, sensor by sensor, or by using the "Assist" menu. See the section on assisted pump setup.

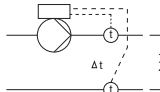

Constant differential temperature

"Controller settings"

For recommended controller settings, see the section on controller settings.

Factory setting

See the section on factory settings.

Related information

[8.11 "Controller" \("Controller settings"\)](#)

[8.41 "Assisted pump setup"](#)

[9.2 Factory settings](#)

8.4.5 "Constant flow rate"

Pump variant	"Constant flow rate"
CME	•
CRE, CRIE, CRNE, CRKE, SPKE, MTRE	•

The pump maintains a constant flow in the system, independently of the head. See the figure below.

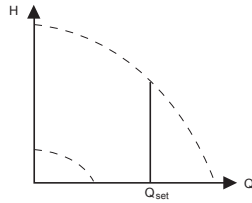

TM057955

Constant flow rate

This control mode requires a flow sensor as shown below:

Example

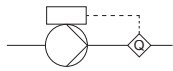

"Constant flow rate"

"Controller settings"

For recommended controller settings, see the section on controller settings.

Factory setting

See the section on factory settings.

Related information

[8.11 "Controller" \("Controller settings"\)](#)

[9.2 Factory settings](#)

8.4.6 "Constant level"

Pump variant	"Constant level"
CME	•
CRE, CRIE, CRNE, CRKE, SPKE, MTRE	•

The pump maintains a constant level, independently of the flow rate. See the figure below.

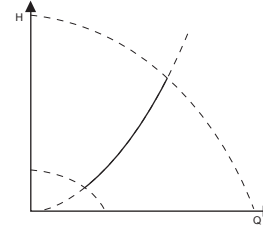

TM057941

"Constant level"

This control mode requires a level sensor.

The pump can control the level in a tank in two ways:

- As an emptying function where the pump draws the liquid from a feed tank.
- As a filling function where the pump pumps the liquid into a storage tank.

See the figure below.

The type of level control function depends on the setting of the built-in controller. See the section on controller settings.

Examples

- One level sensor.
 - emptying function (feed tank).

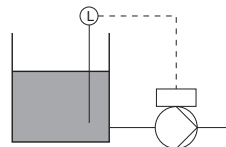

- One level sensor.
 - filling function (storage tank).

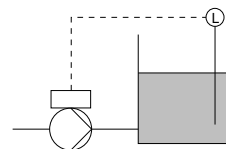

"Constant level"

"Controller settings"

For recommended controller settings, see the section on controller settings.

Factory setting

See the section on factory settings.

Related information

[8.11 "Controller" \("Controller settings"\)](#)

[9.2 Factory settings](#)

8.4.7 "Constant other value"

Pump variant	"Constant other value"
CME	•
CRE, CRIE, CRNE, CRKE, SPKE, MTRE	•

Any other value is kept constant.

Use this control mode if you want to control a value which is not available in the "Control mode" menu. Connect a sensor measuring the controlled value to one of the analog inputs of the pump. The controlled value is shown in percentage of sensor range.

Factory setting

See the section on factory settings.

Related information

[9.2 Factory settings](#)

8.4.8 "Constant curve"

Pump variant	"Constant curve"
CME	•
CRE, CRIE, CRNE, CRKE, SPKE, MTRE	•

You can set the pump to operate according to a constant curve, like an uncontrolled pump. See the figure below.

The desired speed can be set in % of maximum speed in the range from 13 to 100 %.

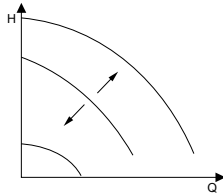

TM057957

"Constant curve"

"Controller settings"

For recommended controller settings, see the section on controller settings.

Factory setting

See the section on factory settings.

Related information

[8.11 "Controller" \("Controller settings"\)](#)

[9.2 Factory settings](#)

8.5 "Analog inputs"

Available inputs depend on the functional module fitted in the pump:

Function (terminal)	FM 200 ¹⁾ (standard)	FM 300 ¹⁾ (advanced)
"Analog input 1, setup" (4)	•	•
"Analog input 2, setup" (7)	•	•
"Analog input 3, setup" (14)	-	•

1) See the section on the identification of functional module.

If you want to set the analog input for a feedback sensor, we recommend that you do this via the "Assisted pump setup" menu. See the section on assisted pump setup.

If you want to set an analog input for other purposes, you can do this manually.

You can set the analog inputs via the "Setup, analog input" menu. See the section on setting up the analog input.

If you make the manual setting via Grundfos GO Remote, you need to enter the menu for the analog input under the "Settings" menu.

Function

The analog inputs can be set to these functions:

- "Not active"
- "Feedback sensor" The sensor is used for the selected control mode.
- "Ext. setpoint infl." See the section on the external setpoint function.
- "Other function".

Measured parameter

Select one of the parameters listed below, i.e. the parameter to be measured in the system by the sensor connected to the actual analog input. See the figure below.

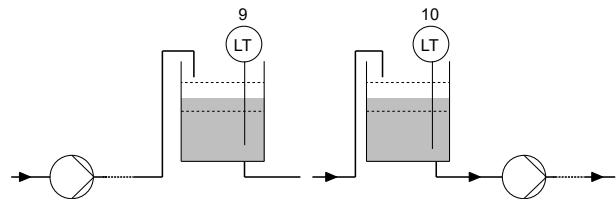
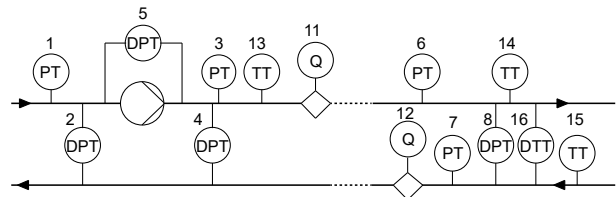

TM062328

Overview of sensor locations

Sensor function/measured parameter	Pos.
"Inlet pressure"	1
"Diff. press., inlet"	2
"Discharge press."	3
"Diff. press., outlet"	4
"Diff. press, pump"	5
"Press. 1, external"	6
"Press. 2, external"	7
"Diff. press., ext."	8
"Storage tank level"	9
"Feed tank level"	10
"Pump flow"	11
"Flow, external"	12
"Liquid temp."	13
"Temperature 1"	14
"Temperature 2"	15
"Diff. temp., ext."	16
"Ambient temp."	Not shown
"Other parameter"	Not shown

"Unit"

Parameter	Possible units
Pressure	"bar", "m", "kPa", "psi", "ft"
Level	"m", "ft", "in"
Pump flow	"m ³ /h", "l/s", "yd ³ /h", "gpm"
Liquid temperature	"°C", "°F"
Other parameter	"%"

"Electrical signal"

Select signal type:

- "0.5-3.5 V"
- "0-5 V"
- "0-10 V"
- "0-20 mA"
- "4-20 mA".

Sensor range, minimum value

Set the minimum value of the connected sensor.

Sensor range, maximum value

Set the maximum value of the connected sensor.

Factory setting

See "Limit 2 exceeded" in the section on factory settings.

Related information

[3.2.2 Identification of functional module](#)

[8.13 "External setpoint function"](#)

[8.41 "Assisted pump setup"](#)

[8.42 "Setup, analog input"](#)

[9.2 Factory settings](#)

8.6 "Pt100/1000 inputs"

Available inputs depend on the functional module fitted in the pump:

Function (terminal)	FM 200 ¹⁾ (standard)	FM 300 ¹⁾ (advanced)
"Pt100/1000 input 1, setup" (17 and 18)	-	•
"Pt100/1000 input 2, setup" (18 and 19)	-	•

1) See the section on the identification of functional module.

If you want to set the Pt100/1000 input for a feedback sensor, we recommend that you do this via the "Assisted pump setup" menu. See the section on assisted pump setup.

If you want to set a Pt100/1000 input for other purposes, you can do this manually.

You can set the analog inputs via the "Setup, analog input" menu. See the section on setting up the analog input.

If you make the manual setting via Grundfos GO Remote, you need to enter the menu for the Pt100/1000 input under the "Settings" menu.

Function

The Pt100/1000 inputs can be set to these functions:

- "Not active"
- "Feedback sensor" The sensor is used for the selected control mode.
- "Ext. setpoint infl." See the section on the external setpoint function.
- "Other function".

Measured parameter

Select one of the parameters listed below, i.e. the parameter to be measured in the system by the PT100/1000 sensor connected to the actual PT100/1000 input. See the figure below.

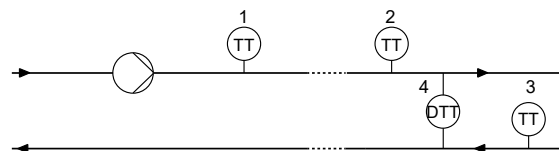

TM084012

Overview of PT100/1000 sensor locations

Parameter	Pos.
"Liquid temp."	1
"Temperature 1"	2
"Temperature 2"	3
"Ambient temp."	Not shown

Measuring range

-50 to 204 °C.

Factory setting

See the section on factory settings.

Related information

[3.2.2 Identification of functional module](#)

[8.13 "External setpoint function"](#)

[8.41 "Assisted pump setup"](#)

[8.42 "Setup, analog input"](#)

[9.2 Factory settings](#)

8.7 "Digital inputs"

Pump variant	"Digital inputs"
CME	•
CRE, CRIE, CRNE, CRKE, SPKE, MTRE	•

Available inputs depend on the functional module fitted in the pump:

Function (terminal)	FM 200 ¹⁾ (standard)	FM 300 ¹⁾ (advanced)
"Digital input 1, setup" (2 and 6)	•	•
"Digital input 2, setup" (1 and 9)	-	•

1) See the section on the identification of functional module.

To set a digital input, make the settings below.

Function

Select one of these functions:

- "Not active". When set to "Not active", the input has no function.
- "External stop". When the input is deactivated (open circuit), the pump stops.
- "Min." (minimum speed). When the input is activated, the pump runs at the set minimum speed.
- "Max." (maximum speed). When the input is activated, the pump runs at the set maximum speed.
- "External fault". When the input is activated, a timer is started. If the input is activated for more than 5 seconds, the pump is stopped and a fault is indicated. This function depends on input from external equipment.
- "Alarm resetting". When the input is activated, a possible fault indication is reset.
- "Dry running". When this function is selected, lack of inlet pressure or water shortage can be detected. When lack of inlet pressure or water shortage (dry running) is detected, the pump is stopped. The pump cannot restart as long as the input is activated. This requires the use of an accessory, such as these:
 - a pressure switch installed on the inlet side of the pump
 - a float switch installed on the inlet side of the pump.
- "Accumulated flow". When this function is selected, the accumulated flow can be registered. This requires the use of a flowmeter which can give a feedback signal as a pulse per defined volume of water. See the section on setting up the pulse flowmeter.
- "Predefined setpoint digit 1" (applies only to digital input 2). When digital inputs are set to predefined setpoint, the pump operates according to a setpoint based on the combination of the activated digital inputs. See the section on predefined setpoints.

The priority of the selected functions in relation to each other appears from the section on the description of settings.

A stop command always has the highest priority.

Activation delay

Select the activation delay (T1).

It is the time between the digital signal and the activation of the selected function.

Range: 0-6000 seconds.

Duration timer mode

Select the mode. See the figure below.

- "Not active"
- active with interrupt (mode A)
- active without interrupt (mode B)
- active with after-run (mode C).

Select the duration time (T2).

It is the time which, together with the mode, determines how long the selected function is active.

Range: 0 to 15,000 seconds.

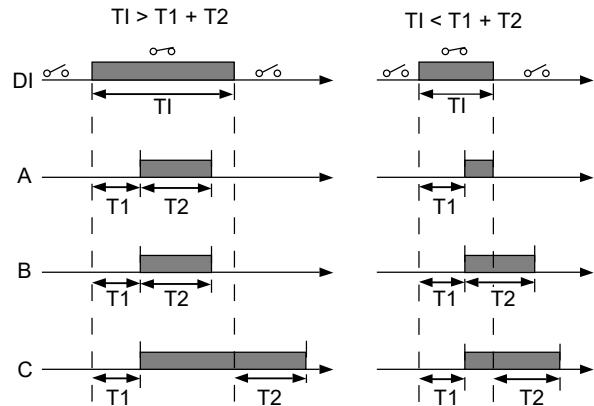

Duration timer function of digital inputs

Pos.	Description
T _I	T _{input}
DI	Digital input
A, B, C	Modes

Factory setting

See the section on factory settings.

Related information

[3.2.2 Identification of functional module](#)

[8.14 "Predefined setpoints"](#)

[8.19 "Pulse flowmeter" \("Pulse flowmeter setup"\)](#)

[9.1 Priority of settings](#)

[9.2 Factory settings](#)

8.8 "Digital inputs/outputs"

Pump variant	"Digital inputs/ outputs"
CME	•
CRE, CRIE, CRNE, CRKE, SPKE, MTRE	•

Available inputs/outputs depend on the functional module fitted in the pump:

Function (terminal)	FM 200 ¹⁾ (standard)	FM 300 ¹⁾ (advanced)
"Digital input/output 3, setup" (6 and 10)	•	•
"Digital input/output 4, setup" (11 and 18)	-	•

1) See the section on the identification of functional module.

You can select if the interface is to be used as input or output. The output is an open collector and you can connect it to e.g. an external relay or controller such as a PLC.

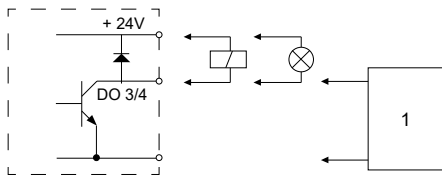

TM064463

Example of configurable digital inputs/outputs

Pos.	Description
1	External controller

To set a digital input/output, make the settings below.

Mode

You can set the digital input/output 3 and 4 to act as digital input or digital output:

- "Digital input"
- "Digital output".

Function

You can set the digital input/output 3 and 4 to the functions stated in the table below:

Possible functions, digital input/output 3

"Function if input" (See details in the section on digital inputs)	"Function if output" (See details in the section on relay outputs)
"Not active"	"Not active"
"External stop"	"Ready"
"Min."	"Alarm"
"Max."	"Operation"
"External fault"	"Pump running"
"Alarm resetting"	"Warning"
"Dry running"	"Limit 1 exceeded"
"Accumulated flow"	"Limit 2 exceeded"
"Predefined setpoint digit 2"	

Possible functions, digital input/output 4

"Function if input" (See details in the section on digital inputs)	"Function if output" (See details in the section on relay outputs)
"Not active"	"Not active"
"External stop"	"Ready"
"Min."	"Alarm"
"Max."	"Operation"
"External fault"	"Pump running"
"Alarm resetting"	"Warning"
"Dry running"	"Limit 1 exceeded"
"Accumulated flow"	"Limit 2 exceeded"
"Predefined setpoint digit 3"	

Activation delay (only for input)

Select the activation delay (T1).

It is the time between the digital signal and the activation of the selected function.

Range: 0-6000 seconds.

Duration timer mode (only for input)

Select the duration timer mode. See the figure below.

- "Not active"
- active with interrupt (mode A)
- active without interrupt (mode B)
- active with after-run (mode C).

Select the duration time (T2).

It is the time which, together with the mode, determines how long the selected function is active.

Range: 0 to 15,000 seconds.

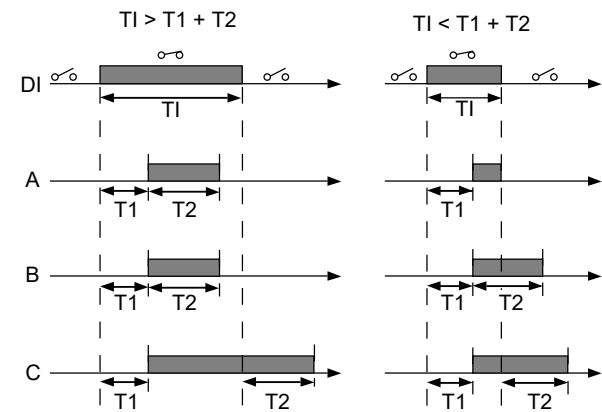

TM081288

Duration timer function of digital inputs

Pos.	Description
T1	T input
DI	Digital input
A, B, C	Modes

Factory setting

See the section on factory settings.

Related information

- 3.2.2 Identification of functional module
- 8.7 "Digital inputs"
- 8.9 "Signal relays" 1 and 2 ("Relay outputs")
- 9.2 Factory settings

8.9 "Signal relays" 1 and 2 ("Relay outputs")

Pump variant	"Signal relays" 1 and 2 ("Relay outputs")
CME	•
CRE, CRIE, CRNE, CRKE, SPKE, MTRE	•

The pump incorporates two signal relays for potential-free signalling. For further information, see the section on megging.

Function

You can configure the signal relays to be activated by one of the following incidents:

- "Not active".
- "Ready".
The pump can be running or is ready to run and no alarms are present.
- "Alarm".
There is an active alarm and the pump is stopped.
- "Operating" ("Operation").
"Operating" equals "Running" but the pump is still in operation when the pump is stopped due to low flow. See the section on low-flow detection.
- "Running" ("Pump running").
The pump is running.
- "Warning".
There is an active warning.
- "Limit 1 exceeded"
When this function is activated, the signal relay is activated. See the section on the limit-exceeded function.
- "Limit 2 exceeded".
When this function is activated, the signal relay is activated. See the section on the limit-exceeded function.
- "External fan control" ("Control of external fan").
When you select "External fan control", the relay is activated if the internal temperature of the motor electronics reach a preset limit value.

Factory setting

See the section on factory settings.

Related information

[8.15 "Limit-exceeded function"](#)

[8.17 "Stop function" \("Low-flow stop function"\)](#)

[9.2 Factory settings](#)

[11.2 Megging](#)

8.10 "Analog output"

Pump variant	"Analog output"
CME	•
CRE, CRIE, CRNE, CRKE, SPKE, MTRE	•

Whether the analog output is available or not, depends on the functional module fitted in the pump:

Function (terminal)	FM 200 ¹⁾ (standard)	FM 300 ¹⁾ (advanced)
"Analog output"	-	•

1) See the section on the identification of functional module.

The analog output enables the reading of certain operating data to external control systems.

To set the analog output, make the settings below.

"Output signal"

- "0-10 V"
- "0-20 mA"
- "4-20 mA".

"Function of analog output"

- "Actual speed"

Signal range [V, mA]	"Actual speed" [%]		
	0	100	200
"0-10 V"	0 V	5 V	10 V
"0-20 mA"	0 mA	10 mA	20 mA
"4-20 mA"	4 mA	12 mA	20 mA

The reading is a percentage of the rated speed.

- "Actual value"

Signal range [V, mA]	"Actual value"	
	Sensor _{min}	Sensor _{max}
"0-10 V"	0 V	10 V
"0-20 mA"	0 mA	20 mA
"4-20 mA"	4 mA	20 mA

The reading is a percentage of the range between the minimum and maximum value.

- "Resulting setpoint"

Signal range [V, mA]	"Resulting setpoint" [%]	
	0	100
"0-10 V"	0 V	10 V
"0-20 mA"	0 mA	20 mA
"4-20 mA"	4 mA	20 mA

The reading is a percentage of the external setpoint range.

- "Motor load"

Signal range [V, mA]	"Motor load" [%]		
	0	100	200
"0-10 V"	0 V	5 V	10 V
"0-20 mA"	0 mA	10 mA	20 mA
"4-20 mA"	4 mA	12 mA	20 mA

The reading is a percentage of the range between 0 and 200 % of the maximum permissible load at the actual speed.

- "Motor current"

Signal range [V, mA]	"Motor current" [%]		
	0	100	200
"0-10 V"	0 V	5 V	10 V
"0-20 mA"	0 mA	10 mA	20 mA
"4-20 mA"	4 mA	12 mA	20 mA

The reading is a percentage of the range between 0 % and 200 % of the rated current.

- "Limit 1 exceeded" and "Limit 2 exceeded"

Signal range [V, mA]	"Limit-exceeded function"	
	Output not active	Output active
"0-10 V"	0 V	10 V
"0-20 mA"	0 mA	20 mA
"4-20 mA"	4 mA	20 mA

This function is typically used for monitoring of secondary parameters in the system. If the limit is exceeded, an output, a warning or an alarm is activated.

- "Flow rate"

Signal range [V, mA]	"Flow rate" [%]		
	0	100	200
"0-10 V"	0 V	5 V	10 V
"0-20 mA"	0 mA	10 mA	20 mA
"4-20 mA"	4 mA	12 mA	20 mA

The reading is a percentage of the range between 0 and 200 % of the nominal flow.

Factory setting

See the section on factory settings.

Related information

[3.2.2 Identification of functional module](#)

[9.2 Factory settings](#)

8.11 "Controller" ("Controller settings")

Pump variant	"Controller" ("Controller settings")
CME	•
CRE, CRIE, CRNE, CRKE, SPKE, MTRE	•

The pumps have a factory default setting of gain (K_p) and integral time (T_i).

However, if the factory setting is not the optimum setting, you can change the gain and the integral time:

- Set the gain within the range from 0.1 to 20.
- Set the integral-action time within the range from 0.1 to 3600 seconds. If you select 3600 seconds, the controller functions as a P controller.

Furthermore, you can set the controller to inverse control.

This means that if you increase the setpoint, the speed is reduced. In the case of inverse control, you must set the gain within the range from -0.1 to -20.

Guidelines for setting of PI controller

The tables below show the recommended controller settings:

Constant differential pressure	K_p	T_i
	0.5	0.5
	0.5	L1 < 5 m: 0.5 L1 > 5 m: 3 L1 > 10 m: 5

L1: distance in meters between pump and sensor.

Constant temperature	K_p		T_i
	Heating system ¹⁾	Cooling system ²⁾	
	0.5	-0.5	10 + 5L2
	0.5	-0.5	30 + 5L2

1) In heating systems, an increase in pump performance results in a rise in temperature at the sensor.

2) In cooling systems, an increase in pump performance results in a drop in temperature at the sensor.

L2: distance in meters between heat exchanger and sensor.

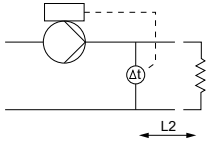
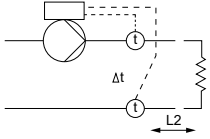
Constant differential temperature	K_p	T_i
	-0.5	$10 + 5L2$
		

L2: Distance [m] between heat exchanger and sensor.

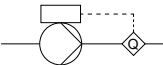
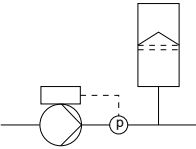
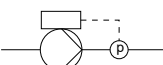
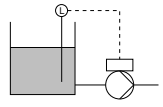
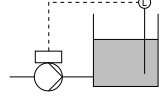
Constant flow rate	K_p	T_i
	0.5	0.5
Constant pressure	K_p	T_i
	0.5	0.5
	0.5	0.5
Constant level	K_p	T_i
	-20	0
	20	0

General rules of thumb

If the controller is too slow-reacting, increase the gain.
 If the controller is hunting or unstable, dampen the system by reducing the gain or increasing the integral time.

Factory setting

See the section on factory settings.

Related information

[9.2 Factory settings](#)

8.12 "Operating range"

Pump variant	"Operating range"
CME	•
CRE, CRIE, CRNE, CRKE, SPKE, MTRE	•

Set the operating range as follows:

- Set the minimum speed within the range from fixed minimum speed to user-set maximum speed.
- Set the maximum speed within the range from user-set minimum speed to fixed maximum speed.

The range between the user-set minimum and maximum speeds is the operating range. See the figure below.

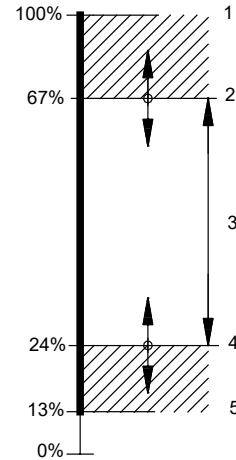

Example of minimum and maximum settings

Pos.	Description
1	Fixed maximum speed
2	User-set maximum speed
3	Operating range
4	User-set minimum speed
5	Fixed minimum speed

Factory setting

See the section on factory settings.

Related information

[9.2 Factory settings](#)

TM006785

8.13 "External setpoint function"

Pump variant	"External setpoint function"
CME	•
CRE, CRIE, CRNE, CRKE, SPKE, MTRE	•

You can influence the setpoint by an external signal, either via one of the analog inputs or, if an advanced functional module (FM 300) is fitted, via one of the Pt100/1000 inputs.



Before you can enable the function, you must set one of the analog inputs or Pt100/1000 inputs to "External setpoint function".

See the sections on analog inputs and Pt100/1000 inputs.

Example with constant pressure with linear influence

Actual setpoint: actual input signal x (setpoint - sensor min.) + sensor min.

At a sensor minimum of 0 psi, a setpoint of 232 psi and an external setpoint of 60 %, the actual setpoint is $0.60 \times (232 - 0) + 0 = 139$ psi. See the figure below.

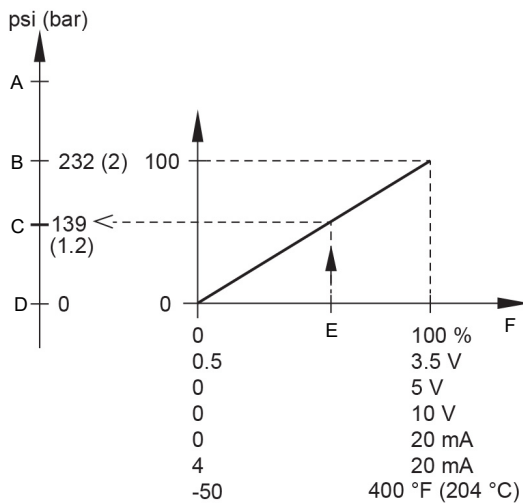

TM080912

Example of setpoint influence with sensor feed back

Pos.	Description
A	Sensor maximum
B	"Setpoint"
C	Actual setpoint
D	Sensor minimum
E	Actual input signal (60 %)
F	External setpoint signal

Example with constant curve with linear influence

Actual setpoint: actual input signal x (setpoint - user-set minimum speed) + user-set minimum speed.

At a user-set minimum speed of 25 %, and a setpoint of 85 % and an external setpoint of 60 %, the actual setpoint is $0.60 \times (85 - 25) + 25 = 61$ %. See the figure below.

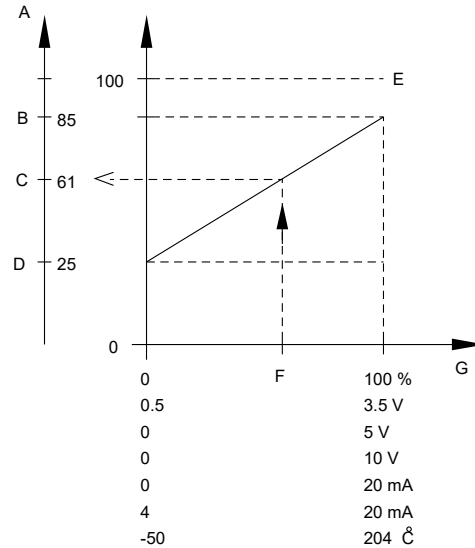

TM080913

Example of setpoint influence with constant curve

Pos.	Description
A	Speed [%]
B	"Setpoint"
C	Actual setpoint
D	User-set min. speed
E	Fixed maximum speed
F	Actual input signal (60 %)
G	External setpoint signal

Related information

- [8.5 "Analog inputs"](#)
- [8.6 "Pt100/1000 inputs"](#)

8.13.1 "Setpoint influence" functions

You can select these functions:

- "Not active".
When set to "Not active", the setpoint is not influenced from any external function.
- "Linear function".
The setpoint is influenced linearly from 0 to 100 %. See the figure below.

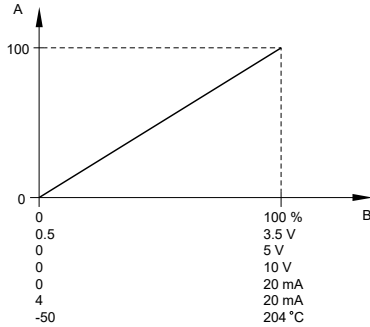

TM064166

"Linear function"

Pos.	Description
A	"Setpoint influence" [%]
B	External input

- "Linear with Stop" and "Linear with Min."
 - "Linear with Stop"
In the input signal range from 20 to 100 %, the setpoint is influenced linearly.
If the input signal is below 10 %, the pump changes to operating mode "Stop".
If the input signal is increased above 15 %, the operating mode is changed back to "Normal".
See the figure below.
 - "Linear with Min."
In the input signal range from 20 to 100 %, the setpoint is influenced linearly.
If the input signal is below 10 %, the pump changes to operating mode "Min.".
If the input signal is increased above 15 %, the operating mode is changed back to "Normal".
See the figure below.

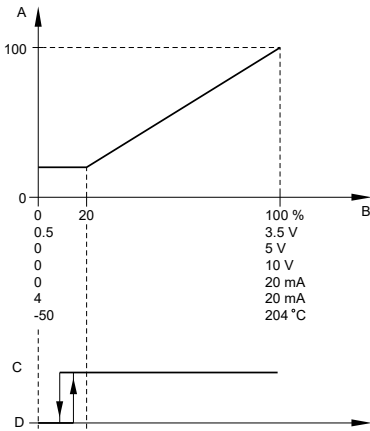

TM064167

"Linear with Stop" and "Linear with Min."

Pos.	Description
A	"Setpoint influence" [%]
B	External input
C	"Normal"
D	"Min." or "Stop"

- "Inverse function". The setpoint is influenced inversely from 0 to 100 %. See the figure below.

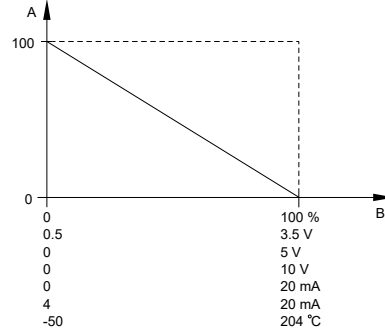

TM080914

"Inverse function"

Pos.	Description
A	"Setpoint influence" [%]
B	External input

- "Inverse with Stop" and "Inverse with Min."
 - "Inverse with Stop"
In the input signal range from 0 to 80 %, the setpoint is influenced inversely.
If the input signal is above 90 %, the pump changes to operating mode "Stop".
If the input signal is reduced below 85 %, the operating mode is changed back to "Normal". See the figure below.
 - "Inverse with Min."
In the input signal range from 0 to 80 %, the setpoint is influenced inversely.
If the input signal is above 90 %, the pump changes to operating mode "Min.".
If the input signal is reduced below 85 %, the operating mode is changed back to "Normal".
See the figure below.

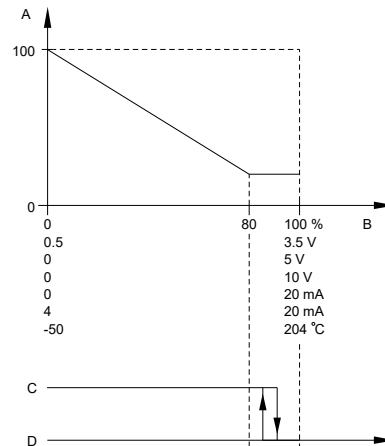

TM080915

"Inverse with Stop" and "Inverse with Min."

Pos.	Description
A	"Setpoint influence" [%]
B	External input
C	"Normal"
D	"Min." or "Stop"

• "Influence table".

The setpoint is influenced by a curve made out of two to eight points. There is a straight line between the points and a horizontal line before the first point and after the last point.

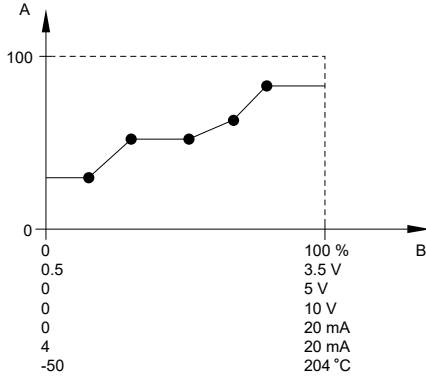

TM064170

"Influence table" (example with five points)

Pos.	Description
A	"Setpoint influence" [%]
B	External input

• "Influence table with Stop at Min.".

The setpoint is influenced by a curve made out of two to eight points. There is straight line between the points and a horizontal line before the first point and after the last point. If the input signal is below 10 %, the pump changes to operating mode "Stop". If the input signal is increased above 15 %, the operating mode is changed back to "Normal". See the figure below.

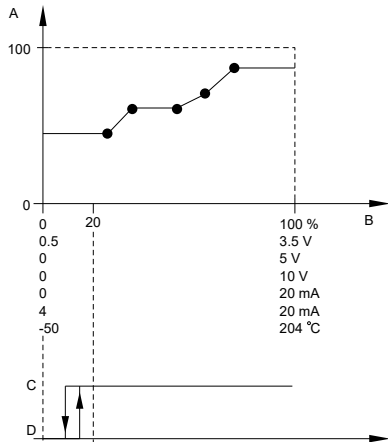

TM080916

"Influence table with Stop at Min." (example with five points)

Pos.	Description
A	"Setpoint influence" [%]
B	External input
C	"Normal"
D	"Min." or "Stop"

• "Influence table with Stop at Max.".

The setpoint is influenced by a curve made out of two to eight points. There is a straight line between the points and a horizontal line before the first point and after the last point. If the input signal is above 90 %, the pump changes to operating mode "Stop". If the input signal is reduced below 85 %, the operating mode is changed back to "Normal". See the figure below.

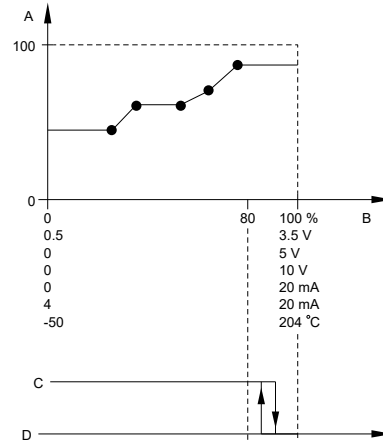

TM080917

"Influence table with Stop at Max." (example with five points)

Pos.	Description
A	"Setpoint influence" [%]
B	External input
C	"Normal"
D	"Min." or "Stop"

Factory setting

See the section on factory settings.

Related information

[9.2 Factory settings](#)

8.14 "Predefined setpoints"

Pump variant	"Predefined setpoints"
CME	•
CRE, CRIE, CRNE, CRKE, SPKE, MTRE	•

You can set and activate seven predefined setpoints by combining the input signals to digital inputs 2, 3 and 4. See the table below.

Set the digital inputs 2, 3 and 4 to "Predefined setpoints" if all seven predefined setpoints are to be used. You can also set one or two of the digital inputs to "Predefined setpoints" but this limits the number of predefined setpoints available.

"Digital inputs"			"Setpoint"
2	3	4	
0	0	0	Normal setpoint or stop
1	0	0	"Predefined setpoints"
0	1	0	"Predefined setpoints"
1	1	0	"Predefined setpoints"
0	0	1	"Predefined setpoints"
1	0	1	"Predefined setpoints"
0	1	1	"Predefined setpoints"
1	1	1	"Predefined setpoints"

0: Open contact
1: Closed contact

Example

The figure below shows how you can use the digital inputs to set seven predefined setpoints. Digital input 2 is open and digital inputs 3 and 4 are closed. If you compare with the table above, you can see that "Predefined setpoints" is activated.

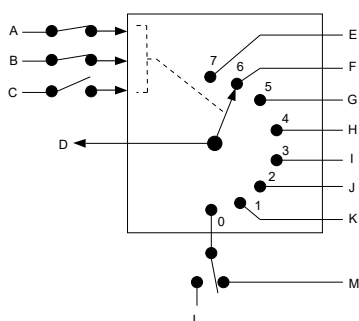

Principle sketch showing how predefined setpoints function

Pos.	Description
A	Digital input 4
B	Digital input 3
C	Digital input 2
D	Actual setpoint
E	Setpoint 7
F	Setpoint 6
G	Setpoint 5
H	Setpoint 4
I	Setpoint 3
J	Setpoint 2
K	Setpoint 1
L	Stop
M	Normal setpoint

If all digital inputs are open, the pump stops or runs at the normal setpoint. Set the desired action with Grundfos GO Remote or with the advanced operating panel.

Factory setting

See the section on factory settings.

Related information

[9.2 Factory settings](#)

8.15 "Limit-exceeded function"

Pump variant	"Limit-exceeded function"
CME	•
CRE, CRIE, CRNE, CRKE, SPKE, MTRE	•

This function can monitor a measured parameter or one of the internal values such as speed, motor load or motor current. If a set limit is reached, a selected action can take place. You can set two limit-exceeded functions meaning that you can monitor two parameters or two limits of the same parameter simultaneously. The function requires setting of the following:

"Measured"

Here you set the measured parameter which is to be monitored.

"Limit"

Here you set the limit which activates the function.

"Hysteresis band"

Here you set the hysteresis band.

"Limit exceeded when"

Here you can set if you want the function to activate when the selected parameter exceeds or drops below the set limit.

- "Above limit".
The function is activated if the measured parameter exceeds the set limit.
- "Below limit".
The function is activated if the measured parameter drops below the set limit.

"Action"

If the value exceeds a limit, you can set an action. You can select the following actions:

- "No action".
The pump remains in its current state. Use this setting if you only want to have a relay output when the limit is reached. See the section on relay outputs.
- "Warning/alarm".
A warning is given.
- "Stop".
The pump stops.
- "Min.".
The pump reduces speed to minimum.
- "Max.".
The pump increases speed to maximum.

Detection delay

You can set a detection delay which ensures that the monitored parameter stays above or below a set limit in a set time before the function is activated.

Resetting delay

The resetting delay is the time from which the measured parameter differs from the set limit including the set hysteresis band and until the function is reset.

Example:

The function is to monitor the outlet pressure from a CRE pump. If the pressure is below 5 bar for more than 5 seconds, a warning must be given. If the outlet pressure is above 7 bar for more than 8 seconds, reset the limit exceeded warning.

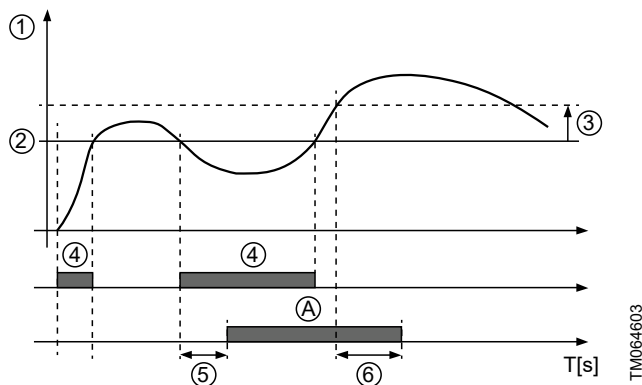

Limit exceeded (example)

Pos.	Setting parameter	Setting
1	"Measured"	Outlet pressure
2	"Limit"	5 bar
3	"Hysteresis band"	2 bar
4	"Limit exceeded when"	Below limit
5	"Detection delay"	5 seconds
6	"Resetting delay"	8 seconds
A	"Limit exceeded function active"	-
-	"Action"	Warning

Factory setting

See the section on factory settings.

Related information

[8.9 "Signal relays" 1 and 2 \("Relay outputs"\)](#)

[9.2 Factory settings](#)

8.16 "LiqTec" ("LiqTec function")

Pump variant	"LiqTec" ("LiqTec function")
CME	•
CRE, CRIE, CRNE, CRKE, SPKE, MTRE	•

You can enable the function of the LiqTec sensors in this display. A LiqTec sensor protects the pump against dry running.

The function requires that a LiqTec sensor has been fitted and connected to the pump.

When you have enabled the LiqTec function, it stops the pump if dry running occurs. Restart the pump manually if it has been stopped due to dry running.

"Dry running detection delay"

You can set a detection delay in order to make sure that the pump is given a chance to start up before the LiqTec function stops the pump due to dry running.

Range: 0-254 seconds.

Factory setting

See the section on factory settings.

Related information

[9.2 Factory settings](#)

8.17 "Stop function" ("Low-flow stop function")

Pump variant	"Stop function" ("Low-flow stop function")
CME	•
CRE, CRIE, CRNE, CRKE, SPKE, MTRE	•

You can set the "Low-flow stop function" to these values:

- "Not active"
- "Energy-optimal mode"
- "High-comfort mode"
- "User-defined mode" ("Customised operating mode").

When the low-flow stop function is active, the flow is monitored. If the flow becomes lower than the set minimum flow (Q_{\min}), the pump changes from continuous operation at constant pressure to start-stop operation and stops if the flow reaches zero.

The advantages of enabling the "Low-flow stop function" are the following:

- no unnecessary heating of the pumped liquid
- reduced wear of the shaft seals
- reduced noise from operation.

The disadvantages of enabling the "Low-flow stop function" may be the following:

- The delivered pressure is not completely constant as it fluctuates between the start and stop pressures.
- The frequent starts/stops of the pump may in some applications cause acoustic noise.

The impact of the above disadvantages very much depends on the setting selected for the stop function.

The "High-comfort mode" setting minimizes pressure fluctuations and acoustic noise.

Select "Energy-optimal mode" if the main priority is to reduce the energy consumption as much as possible.

Possible settings of the stop function:

- "Energy-optimal mode": The pump automatically adjusts the parameters for the stop function so that the energy consumption during the start-stop operation period is minimized. In this case, the stop function uses the factory-set values of the minimum flow ($Q_{\min1}$) and other internal parameters. See the figure below.
- "High-comfort mode": The pump automatically adjusts the parameters for the stop function so that the disturbances during the start-stop operation period are minimized. In this case, the stop function uses the factory-set values of the minimum flow ($Q_{\min2}$) and other internal parameters. See the figure below.
- "User-defined mode" ("Customised operating mode"): The pump uses the parameters set for ΔH and minimum flow ($Q_{\min3}$) respectively for the stop function. See the figure below.

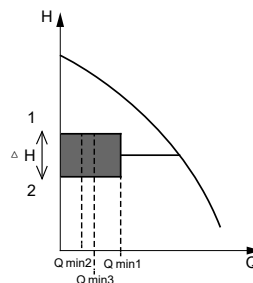

Difference between start and stop pressures (ΔH) and minimum flow rate

Pos.	Description
1	Stop pressure
2	Start pressure

In start-stop operation, the pressure varies between the start and stop pressures. See the figure above.

In "User-defined mode" ("Customised operating mode"), ΔH has been factory-set to 10 % of the actual setpoint. ΔH can be set within the range from 5 to 30 % of actual setpoint.

The pump changes to start-stop operation if the flow becomes lower than the minimum flow.

The minimum flow is set in % of the nominal flow of the pump (see the pump nameplate).

In "User-defined mode" ("Customised operating mode"), the minimum flow has been factory-set to 10 % of nominal flow.

Factory setting

See the section on factory settings.

"Low-flow detection"

Low flow can be detected in two ways:

1. A built-in low-flow detection function which is active if none of the digital inputs are set for flow switch.
 2. A flow switch connected to one of the digital inputs.
1. Low-flow detection function: The pump checks the flow regularly by reducing the speed for a short time. If there is no or only a small change in pressure, this means that there is low flow. The speed is increased until the stop pressure (actual setpoint + 0.5 x ΔH) is reached and the pump stops. When the pressure has fallen to the start pressure (actual setpoint - 0.5 x ΔH), the pump restarts.
 - If the flow is higher than the set minimum flow, the pump returns to continuous operation at constant pressure.
 - If the flow is still lower than the set minimum flow (Q_{min}), the pump continues in start-stop operation until the flow is higher than the set minimum flow (Q_{min}). When the flow is higher than the set minimum flow rate (Q_{min}), the pump returns to continuous operation.
 2. Flow switch: When the digital input is activated for more than 5 seconds because there is low flow, the speed is increased until the stop pressure (actual setpoint + 0.5 x ΔH) is reached, and the pump stops. When the pressure has fallen to start pressure, the pump restarts. If there is still no flow, the pump quickly reaches the stop pressure and stops. If there is flow, the pump continues operating according to the setpoint.

Operating conditions for the low-flow stop function

You can only use the stop function if the system incorporates a pressure sensor, a non-return valve and a diaphragm tank.

Caution Always install the non-return valve before the pressure sensor. See the two figures below.

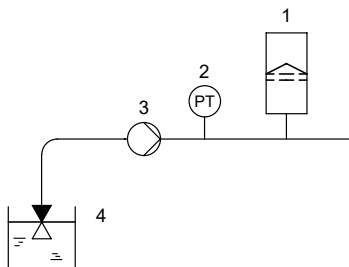

Position of the non-return valve and pressure sensor in system with suction lift operation

TM038582

Pos.	Description
1	Diaphragm tank
2	Pressure sensor
3	Pump
4	Non-return valve

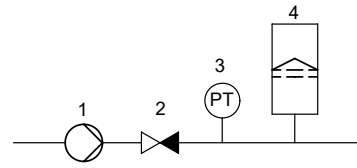

Position of the non-return valve and pressure sensor in a system with a positive inlet pressure

TM038583

Pos.	Description
1	Pump
2	Non-return valve
3	Pressure sensor
4	Diaphragm tank

"Set minimum flow"

Set the minimum flow (Q_{min}) in this display. This setting determines at which flow rate the system is to change from continuous operation at constant pressure to start-stop operation. The setting range is 5 to 30 % of rated flow.

Factory setting

See the section on factory settings.

"Diaphragm tank volume"

The stop function requires a diaphragm tank of a certain minimum size. Set the size of the installed tank in this display.

In order to reduce the number of start-stops per hour or to reduce the ΔH , install a larger tank.

Install the tank immediately after the pump. The precharge pressure must be 0.7 x actual setpoint.

Recommended diaphragm tank size:

Rated flow rate of pump [gpm (m ³ /h)]	CRE pump	Typical diaphragm tank size [gal (liters)]
0-26 (0 - 5.9)	1s, 1, 3	2 (7.6)
27-105 (6.1 - 23.8)	5, 10, 15	4.4 (16.7)
106-176 (24.2 - 40)	20, 32	14 (53.0)
177-308 (40.2 - 70.0)	45	34 (128.7)
309-440 (70.2 - 99.9)	64, 90	62 (234.7)
441-750 (100-170)	120, 150	86 (325.5)

Factory setting

See the section on factory settings.

Related information

[9.2 Factory settings](#)

8.18 "Pipe filling function"

Pump variant	"Pipe filling function"
CME	•
CRE, CRIE, CRNE, CRKE, SPKE, MTR	•

This function is typically used in pressure-boosting applications and ensures a smooth startup of systems with for instance empty pipes. Startup takes place in two phases. See the figure below.

1. Filling phase.

The pipes are slowly filled with water. When the pressure sensor of the system detects that the pipes have been filled, phase two begins.

2. Pressure build-up phase.

The system pressure is increased until the setpoint is reached. The pressure build-up takes place over a pressure build-up time. If the setpoint is not reached within a given time, a warning or an alarm can be given, and the pumps can be stopped at the same time.

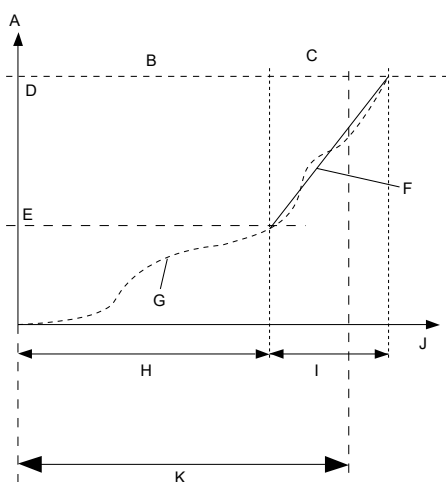

TM080919

Filling and pressure build-up phases

Pos.	Description
A	Pressure
B	Filling phase (constant-curve operation)
C	Pressure build-up phase (constant-pressure operation)
D	"Setpoint"
E	Filling pressure
F	Setpoint ramp-up
G	Actual value
H	Filling time
I	Pressure build-up time
J	Time [sec]
K	Maximum filling time

Setting range

- "Filling speed".
Fixed speed of the pump during the filling phase.
- "filling pressure".
The pressure that the pump must reach before the maximum filling time.
- "max. filling time".
The time in which the pump must reach the filling pressure.

- "Max. time reaction".
Reaction of the pump if the maximum filling time is exceeded:
 - warning
 - alarm (pump stops).
- "Pressure build-up time".
Ramp time from when the filling pressure is reached until the setpoint must be reached.



When you activate this function, the function always starts when the pump has been in operating mode "Stop" and is changed to "Normal".

Factory setting

See the section on factory settings.

Related information

[9.2 Factory settings](#)

8.19 "Pulse flowmeter" ("Pulse flowmeter setup")

Pump variant	"Pulse flowmeter" ("Pulse flowmeter setup")
CME	•
CRE, CRIE, CRNE, CRKE, SPKE, MTR	•

You can connect an external pulse flowmeter to one of the digital inputs in order to register the actual and accumulated flows. Based on this, you can also calculate the specific energy.

To enable a pulse flowmeter, set one of the digital-input functions to "Accumulated flow" and set the pumped volume per pulse. See the section on digital inputs.

Factory setting

See the section on factory settings.

Related information

[8.7 "Digital inputs"](#)

[9.2 Factory settings](#)

8.20 "Ramps"

Pump variant	"Ramps"
CME	•
CRE, CRIE, CRNE, CRKE, SPKE, MTR	•

The ramps determine how quickly the pump can accelerate and decelerate during start-stop or setpoint changes.

You can set the following:

- acceleration time, 0.1 to 300 seconds
- deceleration time, 0.1 to 300 seconds.

The times apply to the acceleration from 0 rpm to maximum (fixed) speed and the deceleration from maximum (fixed) speed to 0 rpm, respectively.

At short deceleration times, the deceleration of the pump may depend on load and inertia as there is no possibility of actively braking the pump.

If the power supply is switched off, the deceleration of the pump only depends on load and inertia.

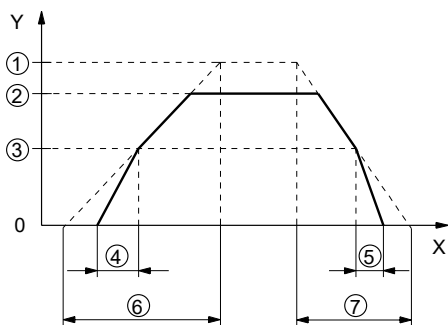

TM069798

"Ramp-up" and "Ramp-down"

Pos.	Description
X	Time
Y	Speed
1	Fixed maximum
2	User-set maximum
3	User-set minimum
4	Fixed initial ramp
5	Fixed final ramp
6	User-set ramp-up
7	User-set ramp-down

Factory setting

See the section on factory settings.

Related information

[9.2 Factory settings](#)

8.21 "Standstill heating"

Pump variant	"Standstill heating"
CME	•
CRE, CRIE, CRNE, CRKE, SPKE, MTR	•

You can use this function to avoid condensation in humid environments. When you set the function to "Active" and the pump is in operating mode "Stop", a low AC voltage is applied to the motor windings. The voltage is not high enough to make the motor rotate but ensures that sufficient heat is generated to avoid condensation in the motor including the electronic parts in the drive.



Remember to remove the drain plugs and fit a cover over the motor.

Factory setting

See the section on factory settings.

Related information

[9.2 Factory settings](#)

8.22 "Motor bearing monitoring"

You can set the motor bearing monitoring function to these values:

- "Active"
- "Not active".

When the function is set to "Active", a counter in the controller starts counting the mileage of the bearings.



The counter continues counting even if the function is changed to "Not active", but a warning will not be given when it is time for replacement or relubrication.

When the function is changed to "Active" again, the accumulated mileage is again used to calculate the replacement or relubrication time.

Factory setting

See the section on factory settings.

Related information

[9.2 Factory settings](#)

8.23 "Service"

"Motor bearing monitoring" must be activated in order for the motor to indicate that the bearings must be replaced or relubricated. See the section on motor bearing monitoring.

For motors of 15 Hp (11 kW) and below, it is not possible to relubricate the bearings.

"Time to next service" ("Motor bearing service")

This display shows when to replace or relubricate the motor bearings. The controller monitors the operating pattern of the motor and calculates the period between bearing replacements or relubrications.

Displayable values:

- "in 2 years"
- "in 1 year"
- "in 6 months"
- "in 3 months"
- "in 1 month"
- "in 1 week"
- "Now".

"Bearing replacements"

This display shows the number of bearing replacements that have been done during the lifetime of the motor.

"Bearings replaced" ("Motor bearing maintenance")

When the bearing monitoring function is active, the controller gives a warning when the motor bearings are due to be replaced.

When you have replaced the motor bearings, press [Bearings replaced].

Related information

[8.22 "Motor bearing monitoring"](#)

8.24 "Number" ("Pump number")

Pump variant	"Number" ("Pump number")
CME	•
CRE, CRIE, CRNE, CRKE, SPKE, MTR	•

You can allocate a unique number to the pump. This makes it possible to distinguish between pumps in connection with GENIbus communication.

Factory setting

See the section on factory settings.

Related information

[9.2 Factory settings](#)

8.25 "Radio communication" ("Enable/disable radio comm.")

Pump variant	"Radio communication" ("Enable/disable radio comm.")
CME	•
CRE, CRIE, CRNE, CRKE, SPKE, MTRE	•

You can set the radio communication to either enabled or disabled. You can use this function in areas where radio communication is not allowed.



IR communication remains active.

Factory setting

See the section on factory settings.

Related information

[9.2 Factory settings](#)

8.26 "Language"

Pump variant	"Language"
CME	•
CRE, CRIE, CRNE, CRKE, SPKE, MTRE	•

This menu is only available in the advanced operating panel.

In this menu, you select the desired language. A number of languages is available.

Factory setting

See the section on factory settings.

Related information

[9.2 Factory settings](#)

8.27 "Date and time" ("Set date and time")

Pump variant	"Date and time" ("Set date and time")
CME	•
CRE, CRIE, CRNE, CRKE, SPKE, MTRE	•

The availability of this menu depends on the functional module fitted in the pump:

Function (terminal)	FM 200 ¹⁾ (standard)	FM 300 ¹⁾ (advanced)
"Date and time"	-	•

1) See the section on the identification of functional module.

You can set date and time as well as how you want them to be viewed in the display:

- "Select date format":
 - "YYYY-MM-DD"
 - "DD-MM-YYYY"
 - "MM-DD-YYYY".
- "Select time format":
 - "HH:MM 24-hour clock"
 - "HH:MM am/pm 12-hour clock".

- "Set date"
- "Set time".

Factory setting

See the section on factory settings.

Related information

[3.2.2 Identification of functional module](#)

[9.2 Factory settings](#)

8.28 "Unit configuration" ("Units")

Pump variant	"Unit configuration" ("Units")
CME	•
CRE, CRIE, CRNE, CRKE, SPKE, MTRE	•

In this menu, you can select between SI and US units. The setting can be made generally for all parameters or you can customize for each parameter.

Factory setting

See the section on factory settings.

Related information

[9.2 Factory settings](#)

8.29 "Buttons on product" ("Enable/disable settings")

Pump variant	"Buttons on product" ("Enable/disable settings")
CME	•
CRE, CRIE, CRNE, CRKE, SPKE, MTRE	•

In this display, you can disable the possibility of making settings for protective reasons.

Grundfos GO Remote

If you set the buttons to "Not active" the buttons on the standard operating panel are disabled. If you set the buttons to "Not active" on pumps fitted with an advanced operating panel, see below.



Advanced operating panel

If you have disabled the settings, you can still use the buttons to navigate through the menus, but you cannot make changes in the "Settings" menu.

When you have disabled the possibility to make settings, the

symbol appears in the display .

Advanced operating panel:

To unlock the motor and allow settings, press  and  simultaneously for at least 5 seconds.

Standard operating panel:



The  button always remains active but you can only unlock all other buttons on the motor with Grundfos GO Remote.

Factory setting

See the section on factory settings.

Related information

[9.2 Factory settings](#)

8.30 "Delete history"

Pump variant	"Delete history"
CME	•
CRE, CRIE, CRNE, CRKE, SPKE, MTRE	•

This menu is only available in the advanced operating panel. In this menu, you can delete the following historic data:

- "Delete operating log".
- "Delete energy consumption".

8.31 "Define Home display"

Pump variant	"Define Home display"
CME	•
CRE, CRIE, CRNE, CRKE, SPKE, MTRE	•

This menu is only available in the advanced operating panel. In this menu, you can set the "Home" display to show up to four user-defined parameters.

Factory setting

See the section on factory settings.

Related information

[9.2 Factory settings](#)

8.32 "Display settings"

Pump variant	"Display settings"
CME	•
CRE, CRIE, CRNE, CRKE, SPKE, MTRE	•

This menu is only available in the advanced operating panel. In this menu, you can adjust the display brightness and set whether or not the display is to turn off if no buttons have been activated for a period of time.

Factory setting

See the section on factory settings.

Related information

[9.2 Factory settings](#)

8.33 "Store settings" ("Store actual settings")

Pump variant	"Store settings" ("Store actual settings")
CME	•
CRE, CRIE, CRNE, CRKE, SPKE, MTRE	•

Grundfos GO Remote

In this menu, you can store the actual settings for later use in the same pump or in other pumps of the same type.

Advanced operating panel

In this menu, you can store the actual settings for later use in the same pump.

8.34 "Recall settings" ("Recall stored settings")

Pump variant	"Recall settings" ("Recall stored settings")
CME	•
CRE, CRIE, CRNE, CRKE, SPKE, MTRE	•

Grundfos GO Remote

In this menu, you can recall stored settings from a number of previously stored settings that the pump then uses.

Advanced operating panel

In this menu, you can recall the last stored settings that the pump then uses.

8.34.1 "Undo"

Pump variant	"Undo"
CME	•
CRE, CRIE, CRNE, CRKE, SPKE, MTRE	•

This menu is only available in Grundfos GO Remote.

In this display, you can undo all settings that have been made with Grundfos GO Remote in the current communication session. Once you have recalled settings, you cannot undo.

8.35 "Pump name"

Pump variant	"Pump name"
CME	•
CRE, CRIE, CRNE, CRKE, SPKE, MTRE	•

This menu is only available in Grundfos GO Remote.

In this display, you can give the pump a name. In this way, you can easily identify the pump when connecting with Grundfos GO Remote.

8.36 "Connection code"

Pump variant	"Connection code"
CME	•
CRE, CRIE, CRNE, CRKE, SPKE, MTRE	•

This menu is only available in Grundfos GO Remote.

You can set a connection code to avoid having to press the connection button each time and to restrict remote access to the product.

Setting the code in the product using Grundfos GO Remote

1. Connect Grundfos GO Remote to the product.
2. In the product dashboard, select "Settings".
3. Choose "Connection code".
4. Enter the wanted code and press [OK]. The code must be a character string (ASCII). You can always change the code. The old code is not needed.

Setting the code in Grundfos GO Remote

You can define a default connection code in Grundfos GO Remote so that it automatically attempts to connect to the selected product via this code.

When you select a product with the same connection code in Grundfos GO Remote, Grundfos GO Remote automatically connects to the product and you do not have to press the connection button on the module.

Define the default code in Grundfos GO Remote in this way:

1. In the main menu, under "General", select "Settings".
2. Choose "Remote".
3. Enter the connection code in the field "Preset connection code". The field now says "Connection code set".

You can always change the default connection code by pressing [Delete] and entering a new one.

If Grundfos GO Remote fails to connect and ask you to press the connection button on the product, it means that the product has no connection code or has a different connection code. In this case, you can only establish connection via the connection button.



After setting a connection code, switch off the product until the light in Grundfos Eye turns off before you can use the new connection code.

8.37 "Run start-up guide"

Pump variant	"Run start-up guide"
CME	•
CRE, CRIE, CRNE, CRKE, SPKE, MTRE	•

This menu is only available in the advanced operating panel.

The startup guide automatically starts when you start the pump for the first time.

You can always run the startup guide later via this menu.

The startup guide guides you through the general settings of the pump.

- "Language". See the section on language.
- "Select date format".* See the section on setting the date and time.
- "Set date".* See the section on setting the date and time.
- "Select time format".* See the section on setting the date and time.
- "Set time".* See the section on setting the date and time.
- "Setting of pump"
 - "Go to Home"
 - "Run with Constant curve"/"Run with Constant pressure". See the section on control mode.
 - "Go to "Assisted pump setup". See the section on assisted pump setup.
 - "Return to factory settings".

* This function applies only for pumps fitted with advanced functional module, FM 300. For further information, see the section on the identification of functional module.

*This function applies only for pumps fitted with advanced functional module, FM 300. For further information, see the section on the identification of functional module.

Related information

[3.2.2 Identification of functional module](#)

[8.4 "Control mode"](#)

[8.26 "Language"](#)

[8.27 "Date and time" \("Set date and time"\)](#)

[8.41 "Assisted pump setup"](#)

8.38 "Alarm log"

This menu contains a list of logged alarms from the product. The log shows the name of the alarm, when the alarm occurred and when it was reset.

8.39 "Warning log"

This menu contains a list of logged warnings from the product. The log shows the name of the warning, when the warning occurred and when it was reset.

8.40 "Assist"

This menu consist of a number of different assist functions which are small guides that take you through the steps needed to set the pump.

8.41 "Assisted pump setup"

Pump variant	"Assisted pump setup"
CME	•
CRE, CRIE, CRNE, CRKE, SPKE, MTRE	•

This menu guides you through the following:

"Setting of pump"

- Selection of control mode. See the section on control mode.
- Configuration of feedback sensors.
- Adjusting the setpoint. See the section on setpoint.
- "Controller settings". See the section on controller settings.
- Summary of settings.

Example of how to use the "Assisted pump setup" for setting up the pump to constant pressure:

Grundfos GO Remote

1. Open the "Assist" menu.
2. Select "Assisted pump setup".
3. Select control mode "Constant pressure" ("Const. pressure").
4. Read the description for this control mode.
5. Select which analog input to use as sensor input.
6. Select sensor function according to where the sensor is installed in the system. See fig. Overview of sensor locations.
7. Select electrical input signal according to the sensor specifications.
8. Select measuring unit according to the sensor specifications.
9. Set the minimum and maximum sensor range values according to the sensor specifications.
10. Set the desired setpoint.
11. Set the gain and integral time of the controller. See the section on controller settings.
12. Type the desired pump name.
13. Check the summary of settings and confirm them.

Advanced operating panel

1. Open the "Assist" menu.
2. Select "Assisted pump setup".
3. Select control mode "Const. pressure".
4. Select which analog input to be used as sensor input.
5. Select the measured parameter which is to be controlled. See fig. Overview of sensor locations.
6. Select measuring unit according to the sensor specifications.
7. Set the minimum and maximum sensor range values according to the sensor specifications.

8. Select electrical input signal according to the sensor specifications.
9. Set the desired setpoint.
10. Set the gain and integral time of the controller. See the section on controller settings.
11. Check the summary of settings and confirm them by pressing [OK].

Related information

[8.1 "Setpoint"](#)

[8.4 "Control mode"](#)

[8.5 "Analog inputs"](#)

[8.11 "Controller" \("Controller settings"\)](#)

8.42 "Setup, analog input"

Pump variant	"Setup, analog input"
CME	•
CRE, CRIE, CRNE, CRKE, SPKE, MTRE	•

This menu is only available in the advanced operating panel.

This menu guides you through the following:

"Setup, analog input"

- "Analog inputs" 1 to 3. See the section on analog inputs.
- "Pt100/1000 input" 1 and 2. See the section on Pt100/1000 inputs.
- "Adjusting the setpoint". See the section on setpoint.
- "Summary".

Related information

[8.1 "Setpoint"](#)

[8.5 "Analog inputs"](#)

[8.6 "Pt100/1000 inputs"](#)

8.43 "Setting of date and time"

Pump variant	"Setting of date and time"
CME	•
CRE, CRIE, CRNE, CRKE, SPKE, MTRE	•

This menu is only available in the advanced operating panel.

Whether this menu is available or not, depends on the functional module fitted in the pump:

Function (terminal)	FM 200 ¹⁾ (standard)	FM 300 ¹⁾ (advanced)
"Setting of date and time"	-	•

- 1) See the section on the identification of functional module.

This menu guides you through the following:

- "Select date format". See the section on setting the date and time.
- "Set date". See the section on setting the date and time.
- "Select time format". See the section on setting the date and time.
- "Set time". See the section on setting the date and time.

Related information

[3.2.2 Identification of functional module](#)

[8.27 "Date and time" \("Set date and time"\)](#)

8.44 "Multi-pump setup" ("Setup of multi-pump system")

Pump variant	"Multi-pump setup" ("Setup of multi-pump system")
CME	•
CRE, CRIE, CRNE, CRKE, SPKE, MTRE	•

The multipump function enables the control of two pumps connected in parallel without the use of external controllers. The pumps in a multipump system communicate with each other via the wireless GENIair connection or the wired GENI connection.

You can set a multipump system via the master pump, that is the first selected pump.

If two pumps in the system are configured with an outlet-pressure sensor, they can all function as master pumps and take over the master pump function if the other should fail. This provides additional redundancy in the multipump system.

The multipump functions are described in the following sections.

8.44.1 "Alternating operation"

Alternating operation functions as a duty/standby operating mode and is possible with two pumps of the same size and type connected in parallel. The main purpose of the function is to ensure an even amount of running hours and to ensure that the standby pump starts if the duty pump stops due to an alarm.

Each pump requires a non-return valve in series with the pump.

You can choose between two alternating operating modes:

- "Alternating operation, time" Change from one pump to the other is based on time.
- "Alternating operation, energy" Change from one pump to the other is based on energy consumption.

If the duty pump fails, the other pump starts.

8.44.2 "Backup operation"

Backup operation is possible with two pumps of the same size and type connected in parallel. Each pump requires a non-return valve in series with the pump.

One pump is operating continuously. The backup pump is operated for a short time each day to prevent seizing up. If the duty pump stops due to a fault, the backup pump starts.

8.44.3 "Cascade operation"

Cascade operation is only available in CRE and CME pumps on request. Contact Grundfos for further information.

Cascade operation is possible with up to four pumps of the same size and type connected in parallel. Each pump requires a non-return valve in series with the pump.

Up to 4 pumps can be operating continuously depending on consumption. Pumps will be cut in and cut out to ensure a constant controlled value, for example, constant pressure, and to ensure a high system efficiency and an even amount of running hours.

8.44.4 "Alternating operation, time"

The interval of alternation between the two pumps. The function is only available in alternating operation.

8.44.5 "Time for pump changeover"

Time of day for a pump changeover to take place. The function is only available in alternating operation.

8.44.6 "Sensor to be used"

Defines the sensor to be used for controlling the pump system. If a sensor is placed in a way that enables it to measure the output from all pumps in the system, for example, in the manifold, then select "Master pump sensor".

If a sensor is placed on or across the individual pumps, for example, installed behind non-return valves and not able to measure the output from all pumps, then select "Running pump sensor".

8.44.7 Setting up a multipump system

You can set a multipump system in the following ways:

- Grundfos GO and wireless pump connection
- Grundfos GO and wired pump connection
- Advanced operating panel and wireless pump connection
- Advanced operating panel and wired pump connection

See step-by-step descriptions below.

Grundfos GO Remote and wireless pump connection

Related information

[8.24 "Number" \("Pump number"\)](#)

[8.24 Numéro \(Numéro de pompe\)](#)

[8.24 "Número" \("N.º de bomba"\)](#)

[8.35 "Pump name"](#)

[8.35 Nom de la pompe](#)

[8.35 "Nombre bom."](#)

[8.41 "Assisted pump setup"](#)

[8.41 Configuration assistée de la pompe](#)

[8.41 "Configuración asistida de la bomba"](#)

[8.44.1 "Alternating operation"](#)

[8.44.2 "Backup operation"](#)

[8.44.1 "Alternating operation"](#)

[8.44.2 "Backup operation"](#)

[8.44.1 "Alternating operation"](#)

[8.44.2 "Backup operation"](#)

8.44.7.1 Grundfos GO Remote and wireless pump connection

1. Power on the pumps.
2. Establish contact to one of the pumps with Grundfos GO Remote.
3. Set the needed analog and digital inputs via Grundfos GO Remote according to the connected equipment and the required functionality. See the section on assisted pump setup.
4. Assign a pump name to the pump using Grundfos GO Remote. See the section on the pump name.
5. Disconnect Grundfos GO Remote from the pump.
6. Establish contact to the next pump.
7. Set the needed analog and digital inputs via Grundfos GO Remote according to the connected equipment and the required functionality. See the section on assisted pump setup.
8. Assign a pump name to the pump using Grundfos GO Remote. See the section on the pump name.
9. Repeat steps 5 to 8 if more pumps are installed in the system.
10. Select the "Assist" menu and choose **Setup of multi-pump system**.
11. Select the desired multipump function. See the sections on alternating operation, backup operation and cascade operation.
12. Press [>] to continue.
13. Set the time for a pump changeover i.e. the time at which the alternation between the two pumps is to take place.



This step applies only if you have selected "Alternating operation, time" and if the motors are fitted with FM 300.

14. Press [>] to continue.

15. Select "Radio" as the communication method to be used between the pumps.

16. Press [>] to continue.

17. Select pump 2.

18. Select the pump from the list.

- If applicable, select pump 3 (only in cascade)
- If applicable, select pump 4 (only in cascade)



Use the [OK] or  button to identify the pump.

19. Press [>] to continue.

20. Confirm the setting by pressing [Send].

21. Press [Finish] in the "Setup complete" dialog box.

22. Wait for the green indicator light in the middle of Grundfos Eye to light up.

8.44.7.2 Grundfos GO Remote and wired pump connection

1. Connect the pumps with each other with a 3-core screened cable between the GENibus terminals A, Y, B.
2. Power on the pumps.
3. Establish contact to one of the pumps with Grundfos GO Remote.
4. Set the needed analog and digital inputs via Grundfos GO Remote according to the connected equipment and the required functionality. See the section on assisted pump setup.
5. Assign a pump name to the pump using Grundfos GO Remote. See the section on the pump name.
6. Assign pump number 1 to the pump. See the section on number.
7. Disconnect Grundfos GO Remote from the pump.
8. Establish contact to the next pump.
9. Set the needed analog and digital inputs via Grundfos GO Remote according to the connected equipment and the required functionality. See the section on assisted pump setup.
10. Assign a pump name to the pump using Grundfos GO Remote. See the section on the pump name.
11. Repeat steps 7 to 10 if more pumps are installed in the system.
12. Select the "Assist" menu and choose **Setup of multi-pump system**.
13. Select the desired multipump function. See the sections on alternating operation, backup operation and cascade operation.
14. Press [>] to continue.
15. Set the time for a pump changeover i.e. the time at which the alternation between the two pumps is to take place.



This step applies only if you have selected "Alternating operation, time" and if the motors are fitted with FM 300.

16. Press [>] to continue.

17. Select "BUS cable" as the communication method to be used between the two pumps.

18. Press [>] to continue.

19. Press "Select pump 2".

20. Select the pump from the list.



Use the [OK] or  button to identify the pump.

21. Press [>] to continue.

22. Confirm the setting by pressing [Send].

23. Repeat steps 19 to 21 if more than two pumps are installed in the system. See the section on cascade operation.

24. Press [Finish] in the "Setup complete" dialog box.

25. Wait for the green indicator light in the middle of Grundfos Eye to light up.

8.44.7.3 Advanced operating panel and wireless pump connection

1. Power on the pumps.
2. On the pumps, set the analog and digital inputs according to the connected equipment and the required functionality. See the section on assisted pump setup.
3. Select the **Assist** menu on one of the pumps, and choose **Setup of multi-pump system**.
4. Press [>] to continue.
5. Select **Wireless** as the communication method to be used between the pumps.
6. Press [>] to continue.
7. Select the desired multipump function. See the sections on alternating operation, backup operation and cascade operation.
8. Press [>] three times to continue.
9. Press [OK] to search for other pumps. The green indicator light in the middle of Grundfos Eye flashes on the other pumps.
10. Press the connect button on the pumps which are to be added to the multipump system.
11. Press [>] to continue.
12. Set the time for a pump changeover i.e. the time at which the alternation between the two pumps is to take place.



This step applies only if you have selected "Alternating operation, time" and if the motors are fitted with FM 300.

13. Press [>] to continue.

14. Press [OK] to confirm the setting. The multipump-function icons appear in the bottom of the operating panels.

8.44.7.4 Advanced operating panel and wired pump connection

1. Connect the pumps with each other with a 3-core screened cable between the GENIbus terminals A, Y, B.
2. On the pumps, set the needed analog and digital inputs according to the connected equipment and the required functionality. See the section on assisted pump setup.
3. Assign pump number 1 to the first pump. See the section on number.
4. Assign pump number 2 to the next pump. See the section on number.
5. Assign pump number 3 and 4 if more than two pumps are installed in the system. See the sections on cascade operation and number.
6. Select the **Assist** menu on one of the pumps and choose **Setup of multi-pump system**.
7. Press [>] to continue.

8. Select **Wired GENIbus** as the communication method to be used between the two pumps.

9. Press [>] twice to continue.

10. Select the desired multipump function. See the sections on alternating operation, backup operation and cascade operation.

11. Press [>] to continue.

12. Press [OK] to search for other pumps.

13. Select the pump from the list.

14. Press [>] to continue.

15. Set the time for a pump changeover i.e. the time at which the alternation between the two pumps is to take place.



This step applies only if you have selected "Alternating operation, time" and if the motors are fitted with FM 300.

16. Press [>] to continue.

17. Press [OK] to confirm the setting. The multipump-function icons appear in the bottom of the operating panels.

8.44.7.5 Disabling a multipump system via Grundfos GO Remote

1. Select the "Assist" menu.
2. Select **Setup of multi-pump system**.
3. Select "Disable".
4. Press [>] to continue.
5. Confirm the setting by pressing [Send].
6. Press [Finish].

8.44.7.6 Disabling a multipump system via the advanced operating panel

1. Select the **Assist** menu.
2. Select **Setup of multi-pump system**.
3. Press [>] to continue.
4. Confirm **No multi-pump function** by pressing [OK].
5. Press [>] to continue.
6. Press [OK] to confirm.

8.45 "Description of control mode"

This menu is only available in the advanced operating panel.

This menu describes each of the possible control modes. See also the section on control mode.

Related information



[8.4 "Control mode"](#)

8.46 "Assisted fault advice"

This menu gives guidance and corrective actions in case of pump failures.

9. Description of settings

9.1 Priority of settings

You can always set the pump to stop by pressing  on the pump operating panel. When the pump is not in "Stop" mode, you can always set the pump to stop by continuously pressing . Furthermore, you can set the pump to maximum speed by continuously pressing . You can always set the pump to operation at maximum speed or to stop with Grundfos GO Remote.

If two or more functions are enabled at the same time, the pump operates according to the function with the highest priority.

Example: If you have set the pump to maximum speed via the digital input, the pump operating panel or Grundfos GO Remote can only set the pump to "Manual" or "Stop".

The priority of the settings appears from the table below:

Priority	Start-stop button	Grundfos GO Remote or operating panel on pump	Digital input	Bus communication
1	"Stop"			
2		"Stop" ¹⁾		
3		"Manual"		
4		"Max. speed" ¹⁾		
5			"Stop"	
6				"Stop"
7				"Max. speed"
8				"Min. speed"
9				"Start"
10			"Max. speed"	
11		"Min. speed"		
12			"Min. speed"	
13			"Start"	
14		"Start"		

1) If the bus communication is interrupted, the pump resumes its previous operating mode, for example "Stop", selected with Grundfos GO Remote or the pump operating panel.

9.2 Factory settings

- Function is enabled.
- Function is disabled.
- Function is not available.

Settings	CRE, CRIE, CRNE, CRKE, SPKE, MTR		
	With factory-fitted sensor	Without factory-fitted sensor	CME
"Setpoint"	75 % of sensor range	75 % of sensor range	75 % of sensor range
"Operating mode"	"Normal"	"Normal"	"Normal"
"Control mode"	"Constant pressure"	"Constant pressure"	"Constant pressure"
"Pipe filling function"	"Not active"	"Not active"	"Not active"
"Buttons on product" ("Enable/disable settings")	"Active"	"Active"	"Active"
"Stop function" ("Low-flow stop function")	"Not active"	"Not active"	"Not active"
"Controller" ("Controller settings")	●	●	●
"Ti"	0.5	0.5	0.5
"Kp"	0.5	0.5	0.5
"Operating range"	50-100 %	50-100 %	50-100 %
"Ramps"			
"Ramp-up"	1 second	1 second	1 second
"Ramp-down"	3 seconds	3 seconds	3 seconds
"Number" ("Pump number")	-	-	-
"Radio communication" ("Enable/disable radio comm.")	"Active"	"Active"	"Active"
"Analog inputs"			
"Analog input 1"	"4-20 mA"	"Not active"	"Not active"
"Analog input 2"	"Not active"	"Not active"	"Not active"
"Analog input 3"	"Not active"	"Not active"	"Not active"
"Pt100/1000 inputs"			
"Pt100/1000 input 1"	"Not active"	"Not active"	"Not active"
"Pt100/1000 input 2"	"Not active"	"Not active"	"Not active"
"Digital inputs"			
"Digital input 1"	"External stop"	"External stop"	"External stop"
"Digital input 2"	"Not active"	"Not active"	"Not active"
"Digital inputs/outputs"			
"Digital in/output 3"	"Not active"	"Not active"	"Not active"
"Digital in/output 4"	"Not active"	"Not active"	"Not active"
"Pulse flowmeter" ("Pulse flowmeter setup")	○	○	○
"Predefined setpoints"	0 psi / 0 bar	0 %	0 %
"Analog output"	"Speed"	"Speed"	Speed
"External setpoint function"	"Not active"	"Not active"	"Not active"
"Signal relays" 1 and 2 ("Relay outputs")			
"Signal relay 1"	"Alarm"	"Alarm"	"Alarm"
"Signal relay 2"	"Running"	"Running"	"Running"
"Limit-exceeded function"			
"Limit 1 exceeded"	"Not active"	"Not active"	"Not active"
"Limit 2 exceeded"	"Not active"	"Not active"	"Not active"
"LiqTec" ("LiqTec function")			
"LiqTec"	"Not active"	"Not active"	"Not active"
"Detection delay time"	40 seconds	40 seconds	40 seconds

Settings	CRE, CRIE, CRNE, CRKE, SPKE, MTR		
	With factory-fitted sensor	Without factory-fitted sensor	CME
<i>"Standstill heating"</i>	"Not active"	"Not active"	"Not active"
<i>"Motor bearing monitoring"</i>	"Not active"	"Not active"	"Not active"
<i>"Pump name"</i>	-	-	-
<i>"Connection code"</i>	-	-	-
<i>"Unit configuration" ("Units")</i>	US	US	US

10. Servicing the product

DANGER

Electric shock

Death or serious personal injury



- Switch off the power supply to the motor and to the signal relays. Wait at least 5 minutes before starting any work on the motor. Make sure that the power supply cannot be switched on accidentally.

DANGER

Magnetic field

Death or serious personal injury



- Do not handle the motor or rotor if you have a pacemaker.

10.1 Motor

For servicing the product, download the service instructions for the motor by using the following link or QR code.



<http://net.grundfos.com/qr/i/98413121>

QR98413121

10.2 Pump

Service documentation is available in Grundfos Product Center (<http://product-selection.grundfos.com/>).

If you have any questions, please contact the nearest Grundfos company or service workshop.

10.3 Cleaning the product

WARNING

Electric shock

Death or serious personal injury



- Switch off the power supply to the motor and to the signal relays. Check that the terminal box cover is intact before spraying water on the product.

In order to avoid condensation in the motor, let the motor cool down before spraying it with cold water.

11. Technical data

11.1 Operating conditions

11.1.1 Maximum number of starts and stops

The number of starts and stops via the power supply must not exceed four times per hour.

When switched on via the power supply, the pump starts after approximately 5 seconds.

If a higher number of starts and stops is desired, use the input for external start-stop when starting and stopping the pump.

When started via an external on/off switch, the pump starts immediately.

11.1.2 Ambient temperature

Ambient temperature during storage and transportation

Minimum: -22 °F (-30 °C)

Maximum: 140 °F (60 °C).

Ambient temperature during operation

1 × 200-240 and 3 × 440-480

Minimum: -4 °F (-20 °C)

Maximum: 122 °F (50 °C).

3 × 200-240

Minimum: -4 °F (-20 °C)

Maximum: 104 °F (40 °C).

The motor can operate with the rated power output (P2) at 122 °F (50 °C), but continuous operation at higher temperatures reduces the expected product life. If the motor is to operate at ambient temperatures between 122 °F (50 °C) and 140 °F (60 °C), select an oversized motor. Contact Grundfos for further information.

11.1.3 Installation altitude



If the motor is installed above 6560 ft (2000 m), it does not comply with SELV/PELV classification.

Installation altitude is the height above sea level of the installation site.

Motors installed up to 3280 ft (1000 meters) above sea level can be loaded 100 %.

- Motors installed more than 3280 ft (1000 meters) above sea level must not be fully loaded due to the low density and consequent low cooling effect of the air. See the figure below.

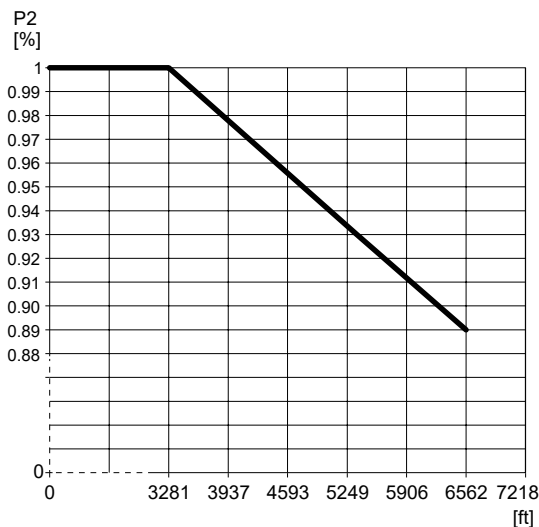

TM069374

Derating of motor output power (P2) in relation to altitude above sea level

11.1.4 Humidity

Maximum humidity: 95 %.

If the humidity is constantly high and above 85 %, open the drain holes in the drive-end flange. See the sections on outdoor installation and drain holes.

Related information

- [5.6 Outdoor installation](#)
- [5.6 Installation extérieure](#)
- [5.6 Instalación en exteriores](#)
- [5.7 Drain holes](#)
- [5.7 Drain holes](#)
- [5.7 Drain holes](#)

11.1.5 Motor cooling

To ensure cooling of motor and electronics, observe the following:

- Position the motor in such a way that adequate cooling is ensured. See the section on ensuring motor cooling.
- The temperature of the cooling air must not exceed 122°F (50°C).
- Keep cooling fins and fan blades clean.

Related information

- [5.5 Ensuring motor cooling](#)

11.2 Megging

Do not meg an installation incorporating MLE motors, as the built-in electronics may be damaged.

11.3 Technical data, single-phase motors

11.3.1 Supply voltage

- 1 × 200-240 V -10 % / +10 %, 50/60 Hz, PE.

Check that the supply voltage and frequency correspond to the values stated on the nameplate.

Recommended fuse size

Motor size Hp [kW]	Minimum [A]	Maximum [A]
0.33 - 1 (0.25 - 0.75)	6	10
1 1/2 - 2 (1.1 - 1.5)	10	16

You can use standard as well as quick-blow or slow-blow fuses.

11.3.2 Leakage current

Ground leakage current less than 3.5 mA, AC.

Ground leakage current less than 10 mA, DC.

The leakage currents are measured in accordance with EN 61800-5-1:2007.

11.4 Technical data, three-phase motors

11.4.1 Supply voltage

- 3 × 440-480 V -10 % / +10 %, 50/60 Hz, PE.

Check that the supply voltage and frequency correspond to the values stated on the nameplate.

Recommended fuse size

Motor size [Hp (kW)]	Minimum [A]	Maximum [A]
0.33 - 1 1/2 (0.25 - 1.1)	6	6
2 (1.5)	6	10
3 (2.2)	6	16
5 (4)	13	16
7 1/2 (5.5)	16	32
10 (7.5)	20	32
15 (11)	32	32

Standard as well as quick-blow or slow-blow fuses may be used.

- 3 × 200-240 V, 60 Hz (supply voltage V)

Recommended fuse size

Motor size [Hp (kW)]	Minimum [A]	Maximum [A]
1 1/2 (1.1)	10	20
2 (1.5)	10	20
3 (2.2)	13	35
5 (4)	25	35
7 1/2 (5.5)	32	35

11.4.2 Leakage current (AC)

Speed [min ⁻¹]	Power [Hp (kW)]	Power supply voltage [V]	Leakage current [mA]
2900-4000	0.33 - 3 (0.25 - 2.2)	≤ 400	< 3.5
		> 400	< 5
	5 - 7 1/2 (4 - 5 1/2)	≤ 400	< 3.5
		> 400	< 3.5
	10 - 15 (7 1/2 - 11)	≤ 400	< 3.5
		> 400	< 5
4000-5900	0.33 - 3 (0.25 - 2.2)	≤ 400	< 3.5
		> 400	< 5
	5 - 7 1/2 (4 - 5.5)	≤ 400	< 3.5
		> 400	< 3.5
	10-15 (7.5 - 11)	≤ 400	< 3.5
		> 400	< 5

The leakage currents are measured in accordance with EN 61800-5-1:2007.

11.5 Inputs/outputs

Ground reference

All voltages refer to ground. All currents return to ground.

Absolute maximum voltage and current limits

Exceeding the following electrical limits may result in severely reduced operating reliability and motor life:

Relay 1:

Maximum contact load: 250 VAC, 2 A or 30 VDC, 2 A.

Relay 2:

Maximum contact load: 30 VDC, 2 A.

GENI terminals: -5.5 to 9.0 VDC or less than 25 mADC.

Other input/output terminals: -0.5 to 26 VDC or less than 15 mADC.

Digital inputs, DI

Internal pull-up current greater than 10 mA at V_i equal 0 VDC.

Internal pull-up to 5 VDC (currentless for V_i greater than 5 VDC).

Certain low logic level: V_i less than 1.5 VDC.

Certain high logic level: V_i greater than 3.0 VDC.

Hysteresis: No.

Screened cable: 0.5 - 1.5 mm², 28-16 AWG.

Maximum cable length: 1640 ft (500 m).

Open-collector digital outputs, OC

Current sinking capability: 75 mADC, no current sourcing.

Load types: Resistive or/and inductive.

Low-state output voltage at 75 mADC: Maximum 1.2 VDC.

Low-state output voltage at 10 mADC: Maximum 0.6 VDC.

Overcurrent protection: Yes.

Screened cable: 0.5 - 1.5 mm², 28-16 AWG.

Maximum cable length: 1640 ft (500 m).

Analog inputs, AI

Voltage signal ranges:

- 0.5 - 3.5 VDC, AL AU.
- 0-5 VDC, AU.
- 0-10 VDC, AU.

Voltage signal: R_i greater than 100 k Ω at 25 °C.

Leak currents may occur at high operating temperatures. Keep the source impedance low.

Current signal ranges:

- 0-20 mADC, AU.
- 4-20 mADC, AL AU.

Current signal: R_i is equal 292 Ω .

Current overload protection: Yes. Change to voltage signal.

Measurement tolerance: -0 / +3 % of full scale (maximum-point coverage).

Screened cable: 0.5 - 1.5 mm², 28-16 AWG.

Maximum cable length: 500 m excluding potentiometer.

Potentiometer connected to +5 V, GND, any AI:

Use maximum 10 k Ω .

Maximum cable length: 100 m.

Analog output, AO

Current sourcing capability only.

Voltage signal:

- Range: 0-10 VDC.
- Minimum load between AO and GND: 1 k Ω .
- Short-circuit protection: Yes.

Current signal:

- Ranges: 0-20 and 4-20 mADC.
- Maximum load between AO and GND: 500 Ω .
- Open-circuit protection: Yes.

Tolerance: -0 / +4 % of full scale (maximum-point coverage).

Screened cable: 0.5 - 1.5 mm², 28-16 AWG.

Maximum cable length: 1640 ft (500 m).

Pt100/1000 inputs, Pt

Temperature range:

- Minimum: -22 °F (-30 °C). 88 Ω / 882 Ω .
- Maximum: 356 °F (180 °C). 168 Ω / 1685 Ω .

Measurement tolerance: \pm 2.5 °F (\pm 1.5 °C).

Measurement resolution: < 0.5 °F (0.3 °C).

Automatic range detection, Pt100 or Pt1000: Yes.

Sensor fault alarm: Yes.

Screened cable: 0.5 - 1.5 mm², 28-16 AWG.

Use Pt100 for short wires.

Use Pt1000 for long wires.

LiqTec sensor inputs

Use Grundfos LiqTec sensor only.

Screened cable: 0.5 - 1.5 mm², 28-16 AWG.

Grundfos Digital Sensor input and output, GDS

Use Grundfos Digital Sensor only.

Power supplies

+5 V:

- Output voltage: 5 VDC -5 % / +5 %.
- Maximum current: 50 mADC (sourcing only).
- Overload protection: Yes.

+24 V:

- Output voltage: 24 VDC -5 % / +5 %.
- Maximum current: 60 mADC (sourcing only).
- Overload protection: Yes.

Digital outputs, relays

Potential-free changeover contacts.

Minimum contact load when in use: 5 VDC, 10 mA.

Screened cable: 0.5 - 2.5 mm², 28-12 AWG.

Maximum cable length: 1640 ft (500 m).

Bus input

Grundfos GENIbus protocol, RS-485.

Screened 3-core cable: 0.5 - 1.5 mm², 28-16 AWG.

Maximum cable length: 1640 ft (500 m).

11.6 Other technical data

EMC (electromagnetic compatibility)

Standard used: EN 61800-3.

The table below indicates the emission category of the motor.

C1: Fulfills the requirements for residential areas.

C3: Fulfills the requirements for industrial areas.

Motor Hp (kW)	Emission category	
	1450-2000 min ⁻¹	2900-4000 min ⁻¹ 4000-5900 min ⁻¹
0.33 (0.25)	C1	C1
1/2 (0.37)	C1	C1
3/4 (0.55)	C1	C1
1 (0.75)	C1	C1
1 1/2 (1.1)	C1	C1
2 (1.5)	C1	C1
3 (2.2)	C1	C1
5 (4)	C1	C1
7 1/2 (5.5)	C3/C1 ¹⁾	C1
10 (7.5)	C3/C1 ¹⁾	C3/C1 ¹⁾
15 (11)	-	C3/C1 ¹⁾

1) C1, if equipped with an external Grundfos EMC filter.

Immunity: Fulfills the requirements for industrial areas.

Contact Grundfos for further information.

Enclosure class

Standard: IP55 (IEC 34-5).

Optional: IP66 (IEC 34-5).

Insulation class

F (IEC 85).

Standby power consumption

5-10 W.

Cable entries

Motor Hp (kW)	Supply voltage	Number and size of cable entries
1/2 - 2 (0.37 - 1.5)	1 × 200-240 V, 50/60 Hz	4 × NPT 1/2"
	3 × 200-240 V, 60 Hz	4 × NPT 1/2"
	3 × 440-480 V, 50/60 Hz	4 × NPT 1/2"
3 (2.2)	3 × 200-240 V, 60 Hz	5 × NPT 1/2"
	3 × 440-480 V, 50/60 Hz	4 × NPT 1/2"
5 (4)	3 × 200-240 V, 60 Hz	5 × NPT 1/2"
	3 × 440-480 V, 50/60 Hz	5 × NPT 1/2"
7 1/2 (5.5)	3 × 200-240 V, 60 Hz	1 × NPT3/4" + 5 × NPT1/2"
	3 × 440-480 V, 50/60 Hz	5 × NPT 1/2"
10 - 15 (7.5 - 11)	3 × 440-480 V, 50/60 Hz	1 × NPT3/4" + 5 × NPT1/2"

The cable entries are fitted with blind plugs from the factory. Cable glands are not provided.

Torques

Terminal	Thread size	Maximum torque [ft lb (Nm)]
L1, L2, L3, L, N	M4	1.3 (1.8)
NC, C1, C2, NO	M2.5	0.4 (0.5)
1-26 and A, Y, B	M2	0.4 (0.5)

11.6.1 Sound pressure level

Motor [Hp (kW)]	Maximum speed stated on nameplate [min ⁻¹]	Speed [min ⁻¹]	Sound pressure level ISO 3743 [dB(A)]	
			1-phase motors	3-phase motors
0.33 - 1 (0.25 - 0.75)	2000	1500	37	37
		2000	43	43
	4000	3000	50	50
		4000	60	60
		4000	58	58
		5900	68	68
1 1/2 (1.1)	2000	1500		37
		2000		43
	4000	3000	50	50
		4000	60	60
		4000	58	58
		5900	68	68
2 (1.5)	2000	1500		42
		2000		47
	4000	3000	57	57
		4000	64	64
		4000	58	58
		5900	68	68
3 (2.2)	2000	1500		48
		2000		55
	4000	3000		57
		4000		64
		4000		58
		5900		68
5 (4)	2000	1500		48
		2000		55
	4000	3000		61
		4000		69
		4000		64
		5900		74
7 1/2 (5.5)	2000	1500		58
		2000		61
	4000	3000		61
		4000		69
		4000		64
		5900		74
10 (7.5)	2000	1500		58
		2000		61
	4000	3000		66
		4000		73
		4000		69
		5900		79

Motor [Hp (kW)]	Maximum speed stated on nameplate [min ⁻¹]	Speed [min ⁻¹]	Sound pressure level ISO 3743 [dB(A)]	
			1-phase motors	3-phase motors
15 (11)	4000	3000		66
		4000		73
	5900	4000		69
		5900		79

The grey fields indicate that the motor is not available in this MLE motor range.

12. Disposing of the product

This product or parts of it must be disposed of in an environmentally sound way.

1. Use the public or private waste collection service.
2. If this is not possible, contact the nearest Grundfos company or service workshop.



The crossed-out wheellie bin symbol on a product means that it must be disposed of separately from household waste. When a product marked with this symbol reaches its end of life, take it to a collection point designated by the local waste disposal authorities. The separate collection and recycling of such products will help protect the environment and human health.

See also end-of-life information at www.grundfos.com/product-recycling.

13. Document quality feedback

To provide feedback about this document, scan the QR-code using your phone's camera or a QR code app.



[Click here to submit your feedback](#)

FEEDBACK098566351

Appendix A

A.1. Installation in the USA and Canada



To maintain the cURus approval, the additional information in this section must be followed.

The UL approval is according to UL 1004-1.

Outdoor installation

According to UL 778/C22.2 No 108-14, pumps intended for outdoor use must be marked enclosure type 3 and the product must be tested at a surface temperature down to -35 °C. The MLE enclosure is approved for type 3 or 4 and is rated at a surface temperature down to 0 °C, thus it is only for indoor use in UL 778/C22.2 No 108-14 pump applications.

For more information about ambient temperature during operation, see the sections on operating conditions and ambient temperature.

Canadian Interference-Causing Equipment Standard

This product complies with the Canadian ICES-003 Class B specifications. This Class B device meets all the requirements of the Canadian interference-causing equipment regulations.

Cet appareil numérique de la Classe B est conforme à la norme NMB-003 du Canada. Cet appareil numérique de la Classe B respecte toutes les exigences du règlement sur le matériel brouilleur du Canada.

A.1.1. Electrical codes

For the USA

This product complies with the Canadian Electrical Code and the US National Electrical Code.

This product has been tested according to the national standards for Electronically Protected Motors:

CSA 22.2 100-14:2014 (applies to Canada only).

UL 1004-1:2015 (applies to USA only).

Pour le Canada

Codes de l'électricité:

Ce produit est conforme au code canadien de l'électricité et au code national de l'électricité américain.

Ce produit a été testé selon les normes nationales s'appliquant aux moteurs protégés électroniquement:

CSA 22.2 100.04: 2009 (s'applique au Canada uniquement).

UL 1004-1: Juin 2011 (s'applique aux États-Unis uniquement).

A.1.2. Radio communication

For the USA

This device complies with Part 15 of the FCC rules and RSS210 of the IC rules. Operation is subject to the following two conditions:

- This device may not cause interference.
- This device must accept any interference, including interference that may cause undesired operation of the device.

Users are cautioned that changes or modifications not expressly approved by Grundfos could void the user's authority to operate the equipment.

Pour le Canada

Ce dispositif est conforme à la partie 15 des règles de la FCC et aux normes RSS210 de l'IC. Son fonctionnement est soumis aux deux conditions suivantes:

- Ce dispositif ne doit pas provoquer de brouillage préjudiciable.
- Il doit accepter tout brouillage reçu, y compris le brouillage pouvant entraîner un mauvais fonctionnement.

A.1.3. Identification numbers

For the USA

Grundfos Holding A/S

Contains FCC ID: OG3-RADIOM01-2G4.

For Canada

Grundfos Holding A/S

Model: RADIOMODULE 2G4

Contains IC: 10447A-RA2G4M01.

Pour le Canada

Numéros d'identification:

Grundfos Holding A/S

Modèle: RADIOMODULE 2G4

Contient IC: 10447A-RA2G4M01.

Location of identification numbers

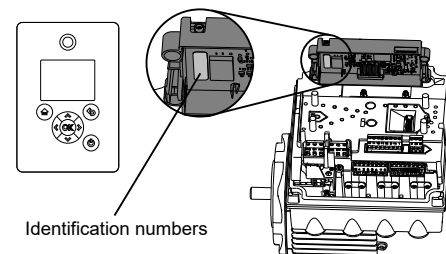
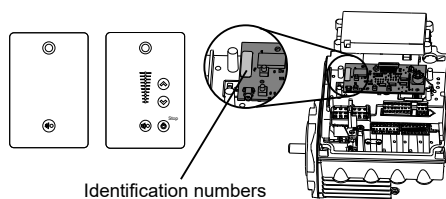

TM069745

TM069746

A.1.4. Electrical connection

Conductors

See the sections on electrical installation and cable requirements.

Torques

See the section on torques.

Line reactors

The maximum line reactor size in front of the drive must not exceed the following values:

P2		Maximum line reactor size [mH]	
[kW]	[HP]	1450-2000 rpm 1450-2200 rpm	2900-4000 rpm 4000-5900 rpm
0.25 - 3	0.5 - 3	1.5	1.5
4	5	0.7	0.7
5.5	7.5	0.9	0.3
7.5	10	0.6	0.6
11	15	0.3	0.3

Exceeding these values creates resonance between the reactor and the drive, which reduces the life of the product.

Short-circuit current

If a short circuit occurs, the pump can be used on a mains supply delivering not more than 5000 RMS symmetrical amperes, 600 V maximum.

Fuses

Fuses used for motor protection must be rated for minimum 500 V. Motors up to and including 10 HP require class K5 UL-listed fuses. Any UL-listed fuse can be used for motors of 15 HP.

Branch-circuit protection

When the pump is protected by a circuit breaker, the circuit breaker must be rated for a maximum voltage of 480 V. The circuit breaker must be of the "inverse time" type.

Overload protection

Degree of overload protection provided internally by the drive, in percent of full-load current: 102 %.

U.S.A.

Global Headquarters for WU
856 Kooamey Road
Brookshire, Texas 77423 USA
Phone: +1-630-236-5500

GRUNDFOS CBS Inc.
902 Kooamey Road
Brookshire, TX 77423 USA
Phone: 281-994-2700
Toll Free: 1-800-955-5847
Fax: 1-800-945-4777

GRUNDFOS Pumps Corporation
9300 Loiret Boulevard
Lenexa, Kansas 66219 USA
Tel.: +1 913 227 3400
Fax: +1 913 227 3500

Canada

GRUNDFOS Canada inc.
2941 Brighton Road
Oakville, Ontario
L6H 6C9
Tel.: +1-905 829 9533
Fax: +1-905 829 9512

Mexico

Bombas GRUNDFOS de México
S.A. de C.V.
Boulevard TLC No. 15
Parque industrial Stiva Aeropuerto
Apodaca, N.L. 66600
Tel.: +52-81-8144 4000
Fax: +52-81-8144 4010

Revision Info

Last revised on 04-2021

98566351 11.2022
ECM: 1353332