

# Submittal Data

PROJECT: _____	UNIT TAG: _____	QUANTITY: _____
REPRESENTATIVE: _____	TYPE OF SERVICE: _____	DATE: _____
ENGINEER: _____	SUBMITTED BY: _____	DATE: _____
CONTRACTOR: _____	APPROVED BY: _____	DATE: _____
	ORDER NO.: _____	DATE: _____



**CUE 1X200-240V IP55 3,0KW DC**

CUE

Note! Product picture may differ from actual product

Conditions of Service	Pump Data	Motor Data
	Maximum ambient temperature: 113 °F Approvals: CE, CULUS, C-TICK Product number: 99616628	Mains frequency: 50 / 60 Hz Enclosure class: IP55 Motor protection: YES Thermal protection: external

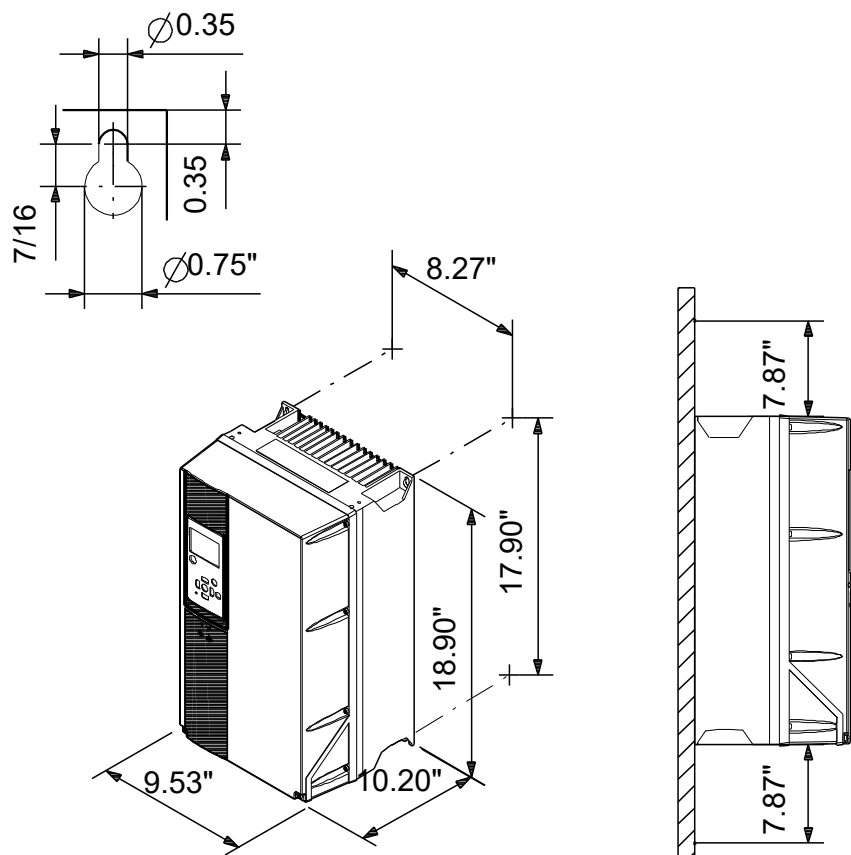

**Materials:**

**Qty. | Description**

1 CUE 1X200-240V IP55 3,0KW DC



**Note! Product picture may differ from actual product**

Product No.: [99616628](#)

CUE is a complete range of external frequency converters designed for speed control of a wide range of Grundfos pumps. CUE has a built-in PI controller and offers the same functionality and user-interface as Grundfos E-pumps. CUE solutions can thus be seen as an extension to the E-pump range.

By choosing a CUE-solution, you will get the following benefits:

- Grundfos E-pump functionality and user-interface
- application- and pump-family-related functions
- increased comfort compared to fixed-speed pumps
- very easy installation and commissioning compared to standard frequency converters
- speed control of pumps up to 250 kW
- speed control of pumps installed in potentially explosive environments.

CUE offers the following inputs and output:

- RS-485 GENIbus
- an analog 0-10 V input for external setpoint
- an analog 0/4-20 mA input for sensor
- four digital inputs for various functions, for instance external start/stop
- two signal relays (C/NO/NC).

Accessories:

Input/output add-on board

Provides additional input:

- one 0/4-20 mA analog input for an additional sensor
- one 0-20 mA analog output
- two inputs for Pt100/Pt1000 temperature sensors, for instance for bearing monitoring.

Motor filters:

For reduction of dU/dt and peak voltages to the motor windings and for reduction of the acoustic noise generated in the motor, a number of motor filters are offered:

- dU/dt filters , 11-250 kW
- Sine wave filters, 0.55-250 kW.

Technical:

Approvals: CE, CULUS, C-TICK

Installation:

Range of ambient temperature: 32 .. 113 °F

Relative humidity: 5-95 %

Electrical data:

Rated power - P2: 4 HP  
Mains frequency: 50 / 60 Hz  
Rated voltage: 1 x 200-240 V  
Rated current: 12.5 A  
Maximum current consumption: 12.5 A  
Efficiency at full load: 96 %  
Enclosure class (IEC 34-5): IP55

Others:

Net weight: 50.7 lb  
Gross weight: 51.2 lb  
Country of origin: US  
Custom tariff no.: 8504.40.4000

Description	Value
<b>General information:</b>	
Product name:	CUE 1X200-240V IP55 3,0KW DC
Product No:	99616628
EAN number:	5713831973331
<b>Technical:</b>	
Approvals:	CE, CULUS, C-TICK
<b>Installation:</b>	
Range of ambient temperature:	32 .. 113 °F
Relative humidity:	5-95 %
Mounted on:	Wall
<b>Electrical data:</b>	
Rated power - P2:	4 HP
Mains frequency:	50 / 60 Hz
Rated voltage:	1 x 200-240 V
Rated current:	12.5 A
Maximum current consumption:	12.5 A
Efficiency at full load:	96 %
Enclosure class (IEC 34-5):	IP55
Built-in motor protection:	YES
Thermal protec:	external
Cable length:	150/300 m
<b>Others:</b>	
Net weight:	50.7 lb
Gross weight:	51.2 lb
Sales region:	Namreg
Country of origin:	US
Custom tariff no.:	8504.40.4000

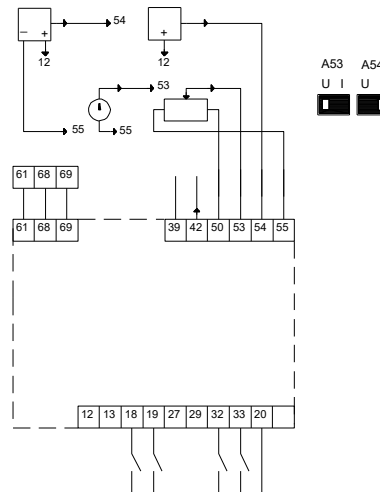
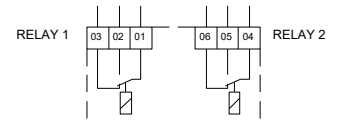
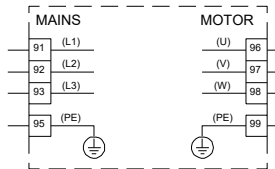
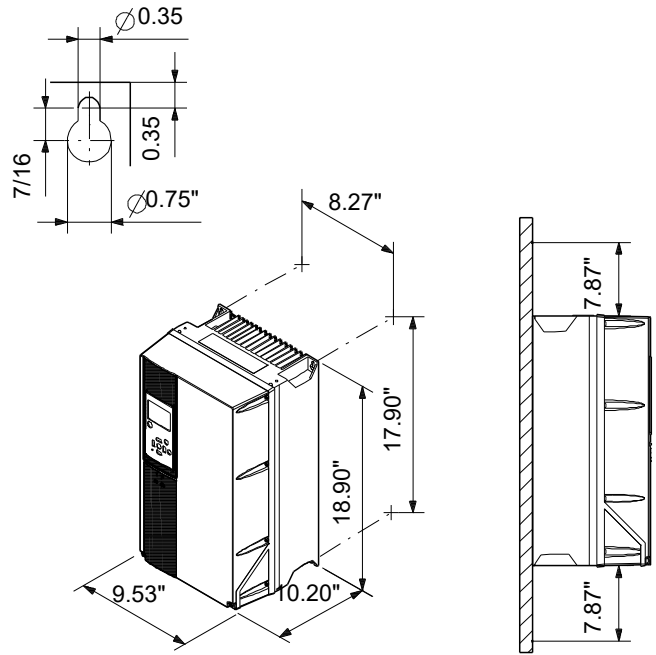

## 99616628 CUE 1X200-240V IP55 3,0KW DC

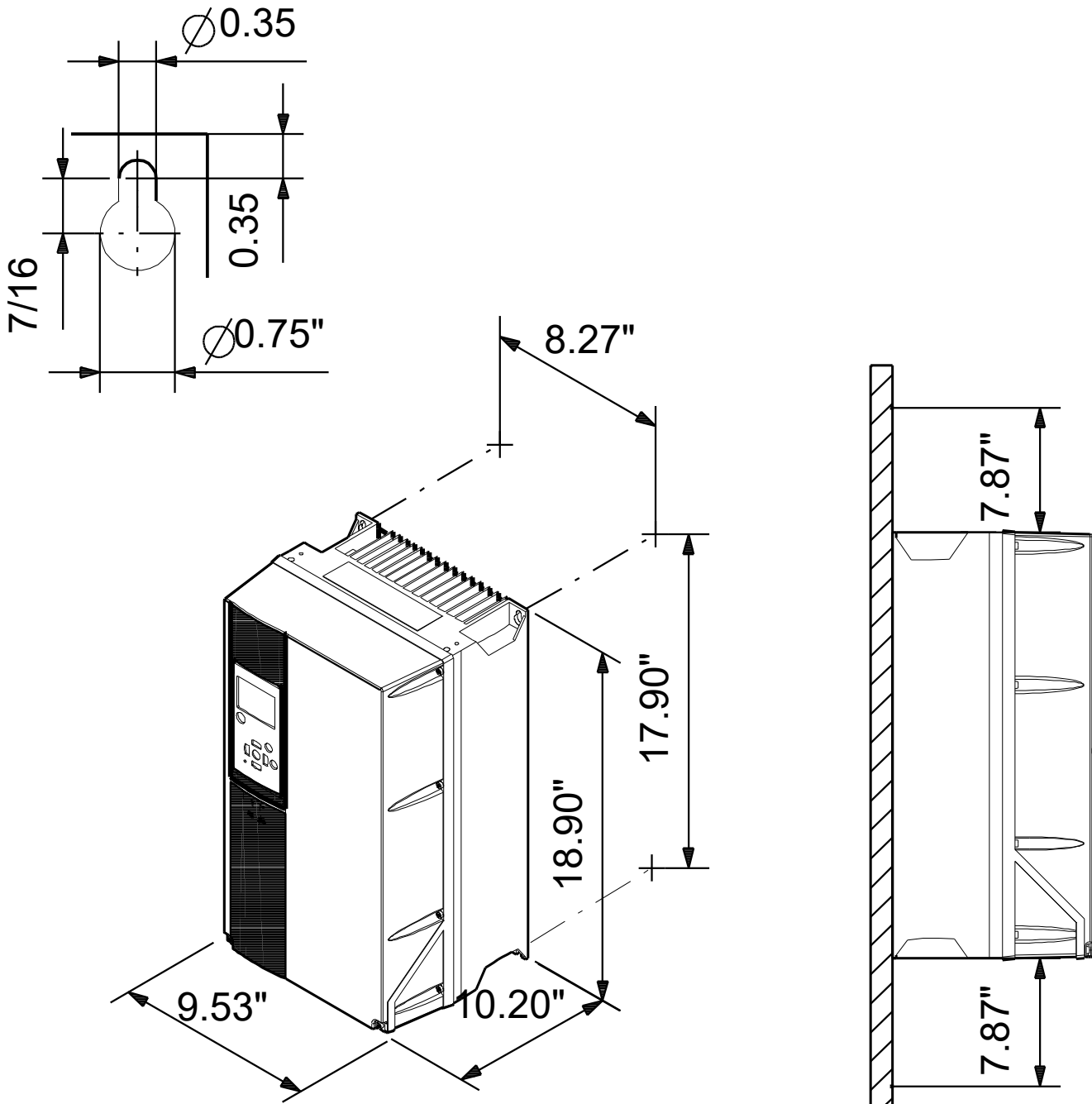

## 99616628 CUE 1X200-240V IP55 3,0KW DC

