

PROJECT: _____	UNIT TAG: _____	QUANTITY: _____
REPRESENTATIVE: _____	TYPE OF SERVICE: _____	DATE: _____
ENGINEER: _____	SUBMITTED BY: _____	DATE: _____
CONTRACTOR: _____	APPROVED BY: _____	DATE: _____
	ORDER NO.: _____	DATE: _____



MTRE 10-12/12 A-WB-A-HUUV

Vertical multistage centrifugal pump with integrated frequency converter designed for tank top mounting and for pumping of cooling lubricants and cutting oils for machine tools, cooling applications, industrial liquid transfer and similar applications.

Note! Product picture may differ from actual product

Conditions of Service		Pump Data		Motor Data	
Liquid:	Emulsion	Max pressure at stated temp:	363 psi / 194 °F	Rated power - P2:	10 HP
Temperature:	68 °F	Liquid temperature range:	14 .. 194 °F	Rated voltage:	440-480 V
Specific Gravity:	1.000	Maximum ambient temperature:	122 °F	Mains frequency:	60 Hz
		Shaft seal:	HUUV	Enclosure class:	IP55
		Product number:	99077587	Insulation class:	F
				Motor protection:	ELEC
				Motor type:	132F
				Eta 1/1:	92.5 %

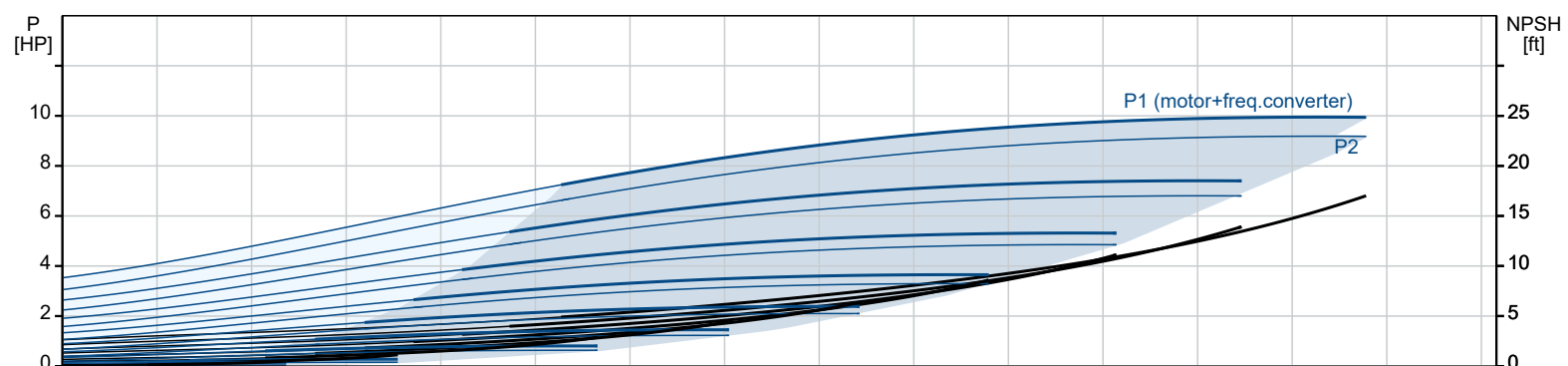
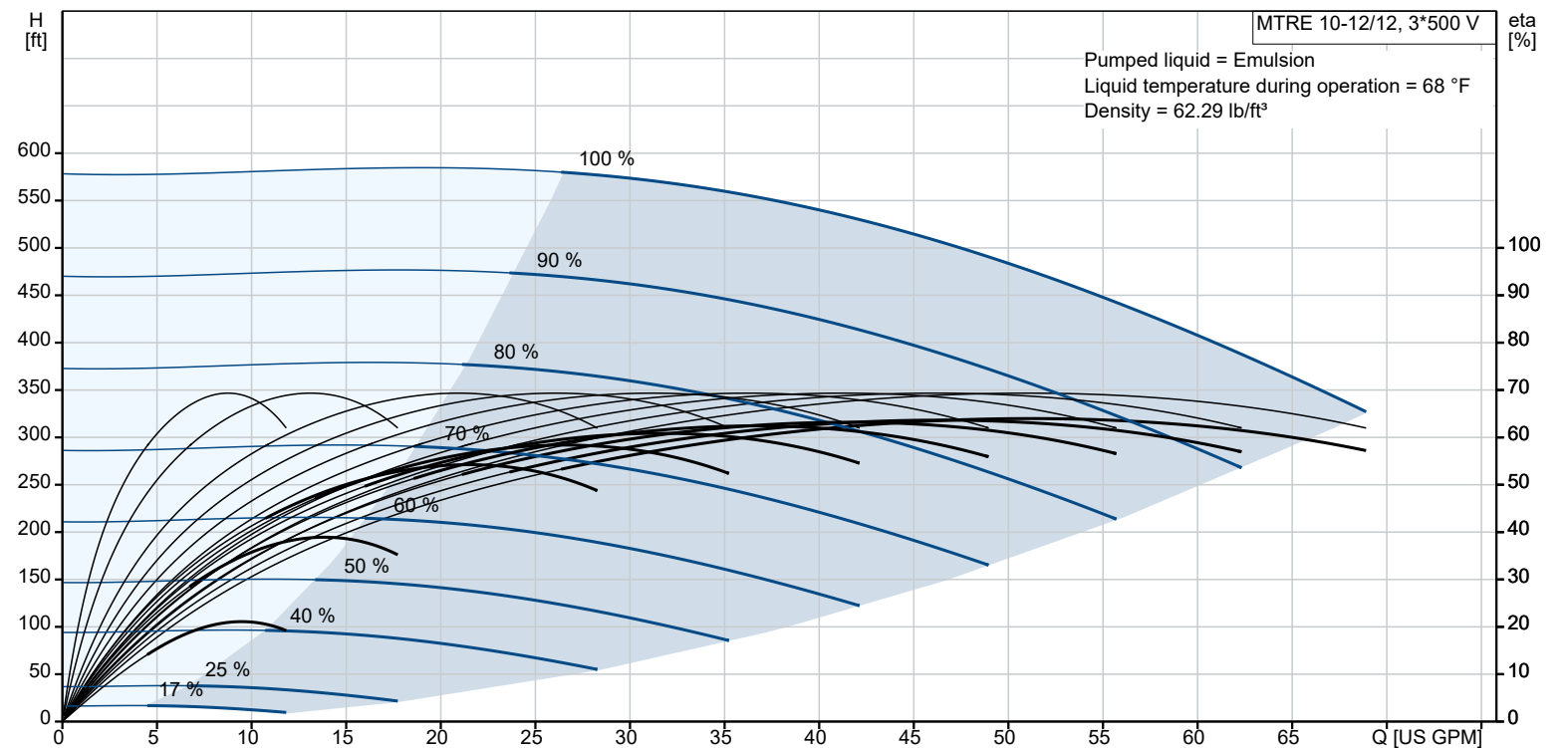

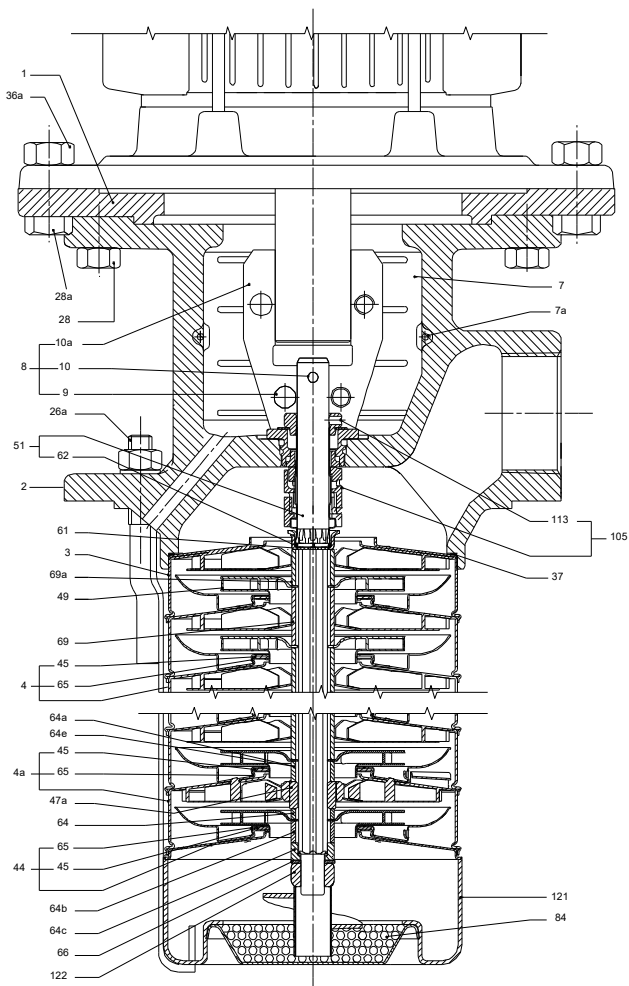
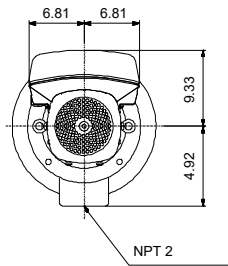
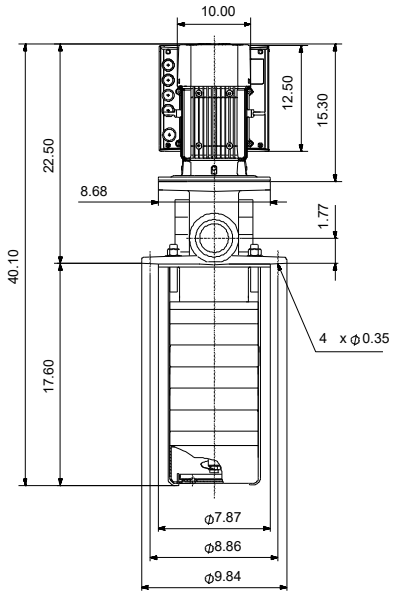

Materials:

Impeller: Stainless steel
 Impeller: AISI 304
 Impeller: EN 1.4301
 Material code: A

Qty.	Description
1	<p data-bbox="87 224 446 257">MTRE 10-12/12 A-WB-A-HUUV</p>  <p data-bbox="87 548 359 582">Product No.: 99077587</p> <p data-bbox="87 604 1037 672">Multistage, immersible, self-priming, centrifugal pump for vertical installation in tanks etc. The pump head and base are in cast iron – all other wetted parts are in stainless steel.</p> <p data-bbox="87 672 638 705">The pump TEST has the following characteristics:</p> <ul data-bbox="127 705 1005 817" style="list-style-type: none"> • Dimensions according to DIN 5440. • Impellers, intermediate chambers and spline shaft are made of Stainless steel. • Mechanical shaft seal according to EN 12756. • Power transmission via sintered metal split coupling. <p data-bbox="87 851 1053 884">A cartridge shaft seal ensures high reliability, safe handling, and easy access and service.</p> <p data-bbox="87 884 1021 918">The pump is fitted with a 3-phase, fan-cooled, permanent-magnet, synchronous motor.</p> <p data-bbox="87 918 1548 996">The motor includes a frequency converter and PI controller in the motor terminal box. This enables continuously variable control of the motor speed, which again enables adaptation of the performance to a given requirement. The operating panel on the motor terminal box features a four-inch TFT display, push-buttons and the Grundfos Eye indicator.</p> <p data-bbox="87 996 861 1030">The display gives an intuitive and user-friendly interface to all functions.</p> <p data-bbox="87 1030 1532 1086">The push-buttons are used to navigate through the menu structure to access pump and performance data on site and enable setting of required setpoint as well as setting of pump to "Min." or "Max." operation or to "Stop".</p> <p data-bbox="87 1086 1085 1120">The Grundfos Eye indicator on the operating panel provides visual indication of pump status:</p> <ul data-bbox="127 1120 1404 1209" style="list-style-type: none"> • "Power on": Motor is running (rotating green indicator lights) or not running (permanently green indicator lights) • "Warning": Motor is still running (rotating yellow indicator lights) or has stopped (permanently yellow indicator lights) • "Alarm": Motor has stopped (flashing red indicator lights). <p data-bbox="87 1209 1556 1265">Communication with the pump is also possible by means of Grundfos GO Remote (accessory). The remote control enables further settings as well as reading out of a number of parameters such as "Actual value", "Speed", "Power input" and total "Power consumption".</p> <p data-bbox="87 1288 1516 1344">The terminal box has a number of inputs and outputs enabling the motor to be used in advanced applications where many inputs and outputs are required:</p> <ul data-bbox="127 1344 782 1713" style="list-style-type: none"> • two dedicated digital inputs • three analog inputs, 0(4)-20 mA, 0-5 V, 0-10 V, 0.5-3.5 V • 5 V voltage supply to potentiometer and sensor • one analog output, 0-10 V, 0(4)-20 mA • two configurable digital inputs or open-collector outputs • two Pt100/Pt1000 inputs • LiqTec, dry-running protection sensor input • Grundfos Digital Sensor input and output • 24 V voltage supply for sensors • two signal-relay outputs (potential-free contacts) • GENIbus connection • interface for Grundfos CIM fieldbus module. <p data-bbox="87 1736 534 1769">Immersion depth: 17.6 in</p> <p data-bbox="87 1792 534 1859">Controls: Frequency converter: Built-in</p> <p data-bbox="87 1881 582 2038">Liquid: Pumped liquid: Emulsion Liquid temperature range: 14 .. 194 °F Selected liquid temperature: 68 °F Density: 62.29 lb/ft³</p> <p data-bbox="87 2060 718 2195">Technical: Pump speed on which pump data are based: 3470 rpm Rated flow: 53.3 US GPM Rated head: 446.5 ft</p>

Qty.	Description
1	<p>Chambers: 12</p> <p>Drainage back to tank: N</p> <p>Pump orientation: Vertical</p> <p>Code for shaft seal: HUUUV</p> <p>Approvals: CE,UKCA,RCM,cURus/cCSAus</p> <p>Approvals for motor: CE, RCM, cURus, IE5, IES2,UKCA, SEPRO</p> <p>Energy approvals for motor: CE</p> <p>Curve tolerance: ISO9906:2012 3B</p> <p>Cable gland entry: 1 x NPT 3/4" + 5 x NPT 1/2"</p> <p>Materials:</p> <p>Pump head: Cast iron EN 1561 EN-GJL-200 ASTM A48-25B</p> <p>Impeller: Stainless steel EN 1.4301 AISI 304</p> <p>Installation:</p> <p>Maximum ambient temperature: 122 °F</p> <p>Maximum operating pressure: 362.59 psi</p> <p>Max pressure at stated temp: 363 psi / 194 °F</p> <p>Type of connection: NPT(F)</p> <p>Size of outlet connection: 2 inch</p> <p>Immersion depth: 17.6 in</p> <p>Flange size for motor: 213TC</p> <p>Electrical data:</p> <p>Motor standard: NEMA</p> <p>Motor type: 132F</p> <p>Rated power - P2: 10 HP</p> <p>Mains frequency: 60 Hz</p> <p>Suitable for 50/60 Hz: Y</p> <p>Rated voltage: 3 x 440-480 V</p> <p>Service factor: 1.15</p> <p>Rated current: 12.4-11.5 A</p> <p>Cos phi - power factor: 0.91-0.90</p> <p>Rated speed: 360-4000 rpm</p> <p>IE Efficiency class: IE5</p> <p>Motor efficiency at full load: 92.5 %</p> <p>Enclosure class (IEC 34-5): IP55</p> <p>Insulation class (IEC 85): F</p> <p>Motor No: 99256776</p> <p>Others:</p> <p>Terminal box position: 6</p> <p>Minimum efficiency index, MEI ≥: 0.70</p> <p>Net weight: 156 lb</p> <p>Gross weight: 220 lb</p> <p>Shipping volume: 16.9 ft³</p>

99077587 MTRE 10-12/12 A-WB-A-HUUV 60 Hz

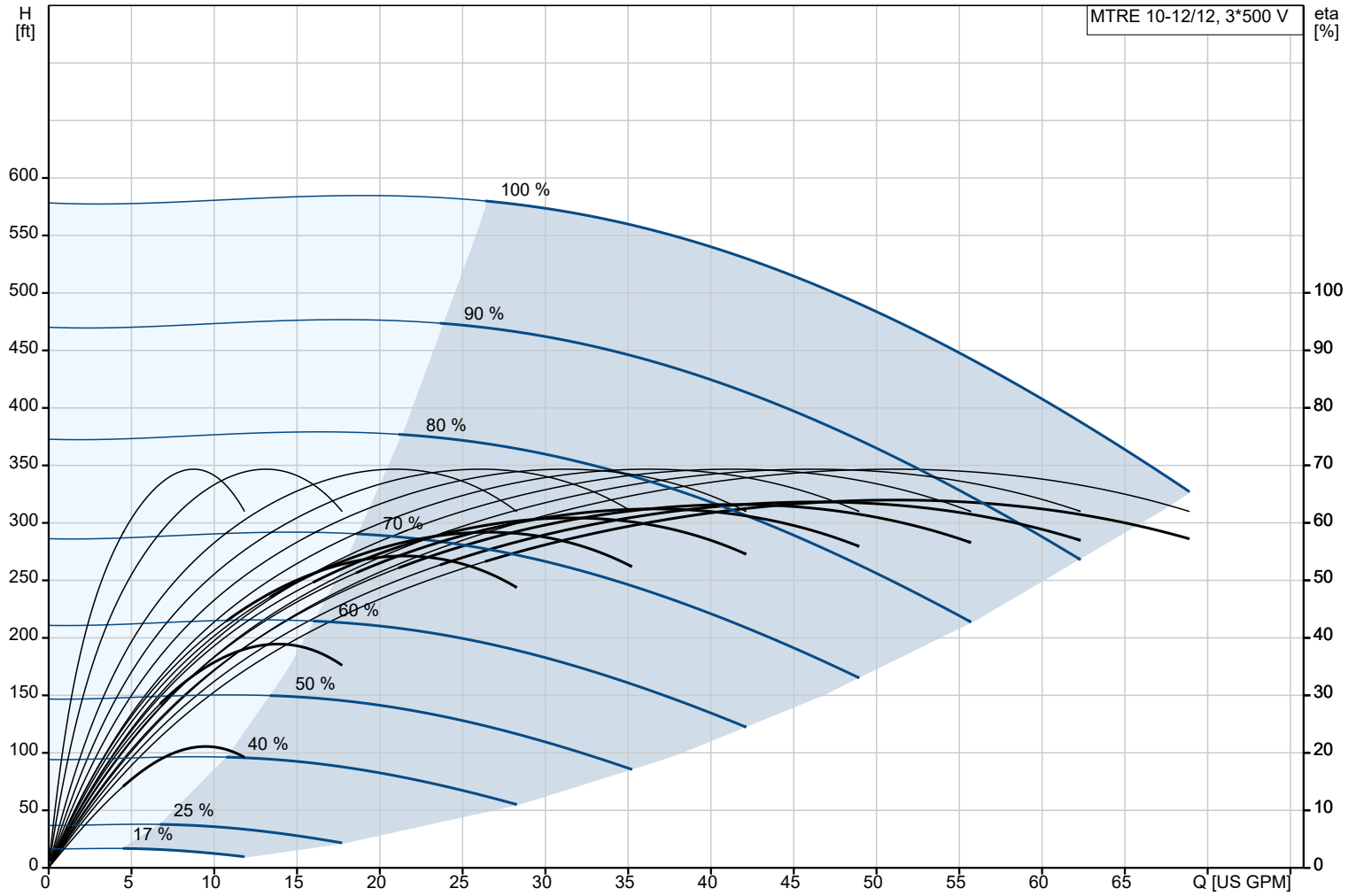

Pumped liquid = Emulsion
Liquid temperature during operation = 68 °F
Density = 62.29 lb/ft³

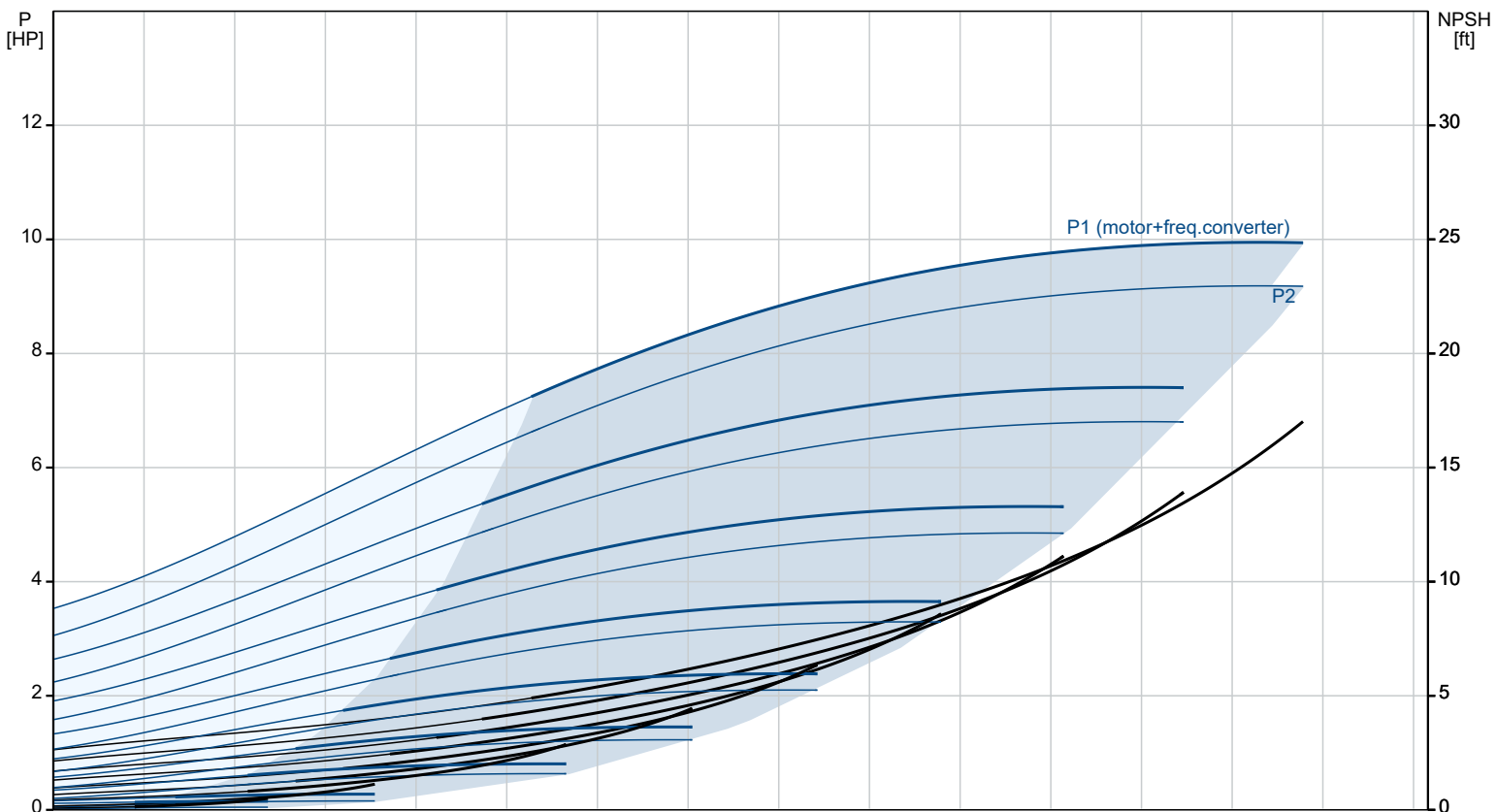

eta [%]

0
10
20
30
40
50
60
70
80
90
100

NPSH [ft]

0
5
10
15
20
25
30

Description	Value
General information:	
Product name:	MTRE 10-12/12 A-WB-A-HUUV
Product No:	99077587
EAN number:	5712606311736
Technical:	
Pump speed on which pump data are based:	3470 rpm
Rated flow:	53.3 US GPM
Rated head:	446.5 ft
Chambers:	12
Impellers:	12
Number of reduced-diameter impellers:	0
Drainage back to tank:	N
Pump orientation:	Vertical
Code for shaft seal:	HUUV
Approvals:	CE, UKCA, RCM, cURus/cCSAus
Approvals for motor:	CE, RCM, cURus, IE5, IES2, UKCA, SEPRO
Energy approvals for motor:	CE
Curve tolerance:	ISO9906:2012 3B
Pump version:	A
Model:	A
Cable gland entry:	1 x NPT 3/4" + 5 x NPT 1/2"
Materials:	
Pump head:	Cast iron
Pump head:	EN 1561 EN-GJL-200
Pump head:	ASTM A48-25B
Impeller:	Stainless steel
Impeller:	EN 1.4301
Impeller:	AISI 304
Material code:	A
Installation:	
Maximum ambient temperature:	122 °F
Maximum operating pressure:	362.59 psi
Max pressure at stated temp:	363 psi / 194 °F
Type of connection:	NPT(F)
Size of outlet connection:	2 inch
Immersion depth:	17.6 in
Flange size for motor:	213TC
Connect code:	WB
Liquid:	
Pumped liquid:	Emulsion
Liquid temperature range:	14 .. 194 °F
Selected liquid temperature:	68 °F
Density:	62.29 lb/ft³
Electrical data:	
Motor standard:	NEMA
Motor type:	132F
Rated power - P2:	10 HP
Mains frequency:	60 Hz
Suitable for 50/60 Hz:	Y
Rated voltage:	3 x 440-480 V
Service factor:	1.15
Rated current:	12.4-11.5 A
Cos phi - power factor:	0.91-0.90
Rated speed:	360-4000 rpm
IE Efficiency class:	IE5
Motor efficiency at full load:	92.5 %
Enclosure class (IEC 34-5):	IP55
Insulation class (IEC 85):	F
Built-in motor protection:	ELEC
Motor No:	99256776
Controls:	
Control panel:	Graphical
Function Module:	FM300 - Advanced

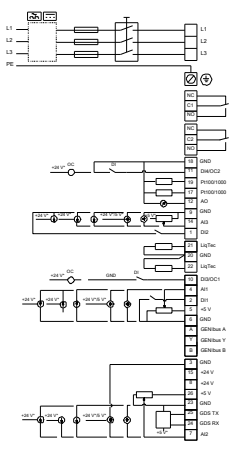
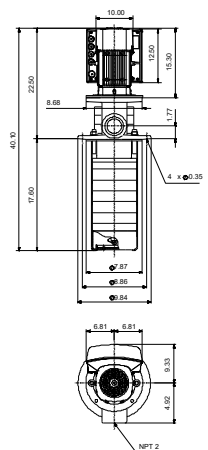
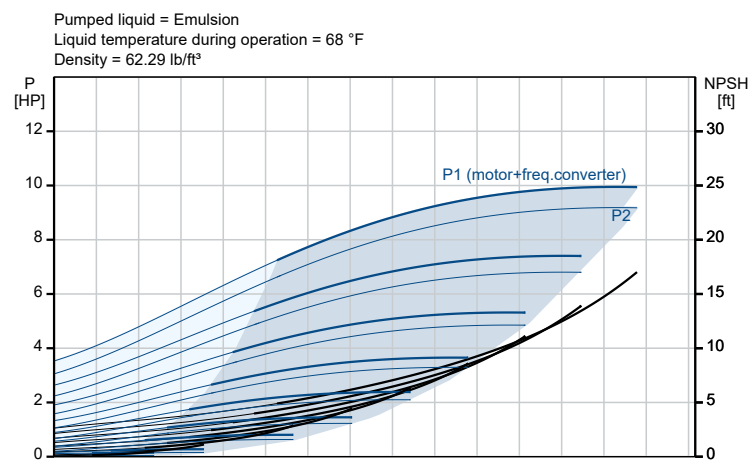
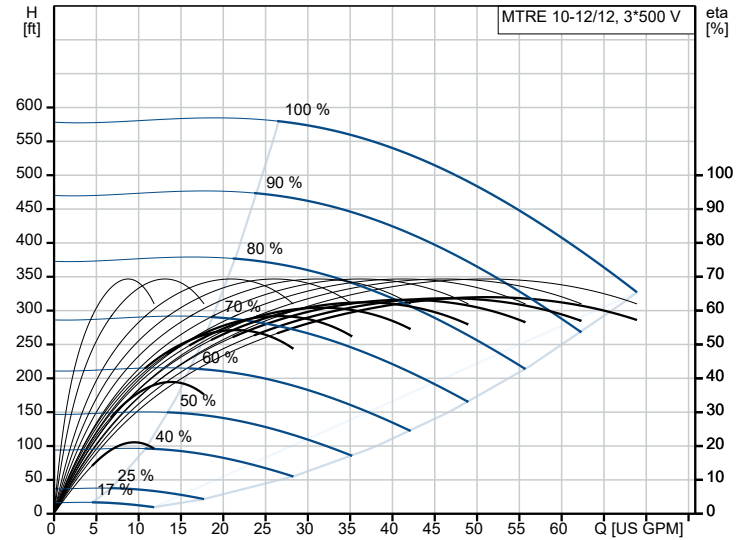



Company name:

Created by:

Phone:

Date:

24/04/2024

Description	Value
Frequency converter:	Built-in
Others:	
Terminal box position:	6
Minimum efficiency index, MEI ≥:	0.70
Net weight:	156 lb
Gross weight:	220 lb
Shipping volume:	16.9 ft ³

99077587 MTRE 10-12/12 A-WB-A-HUUV 60 Hz

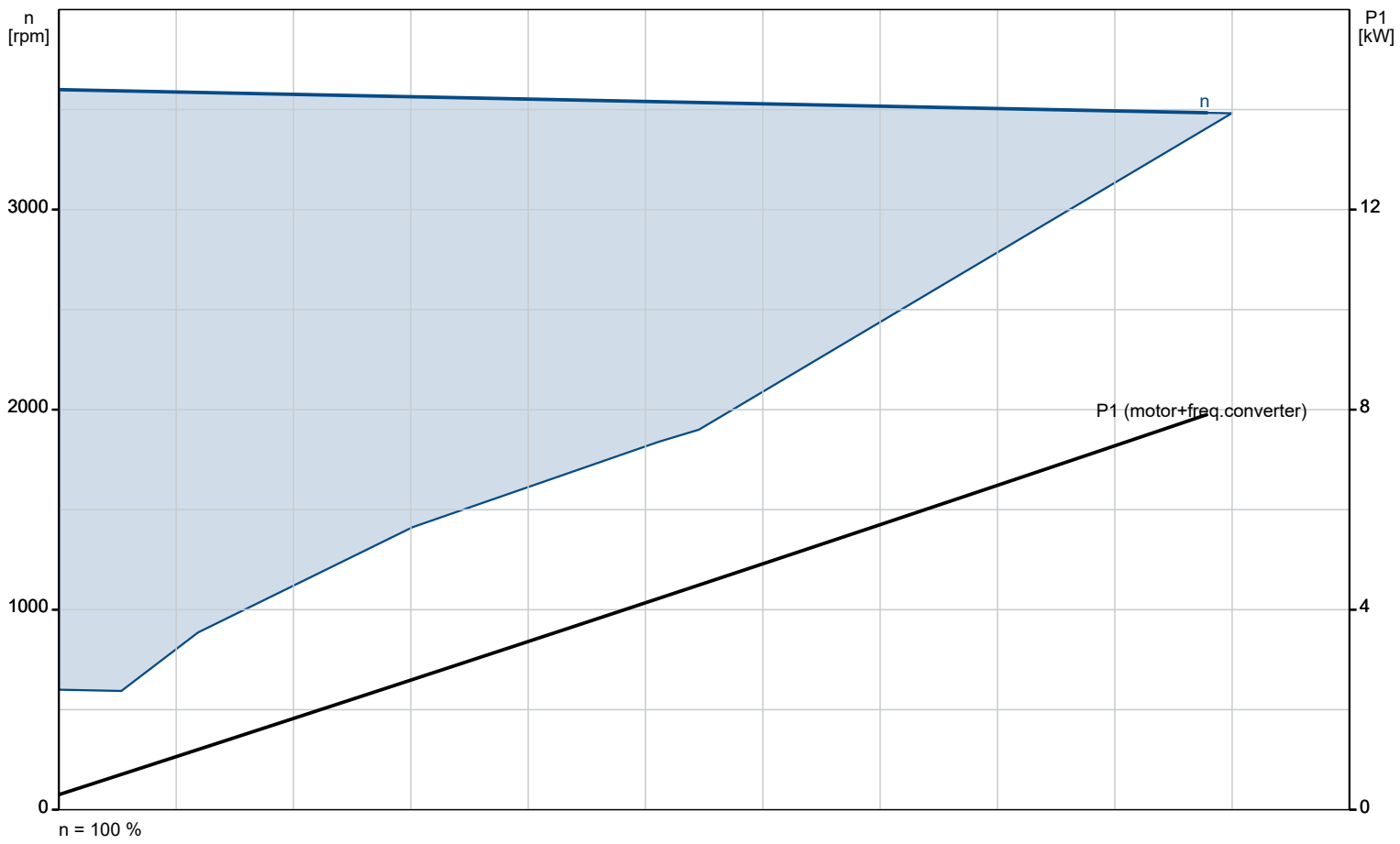
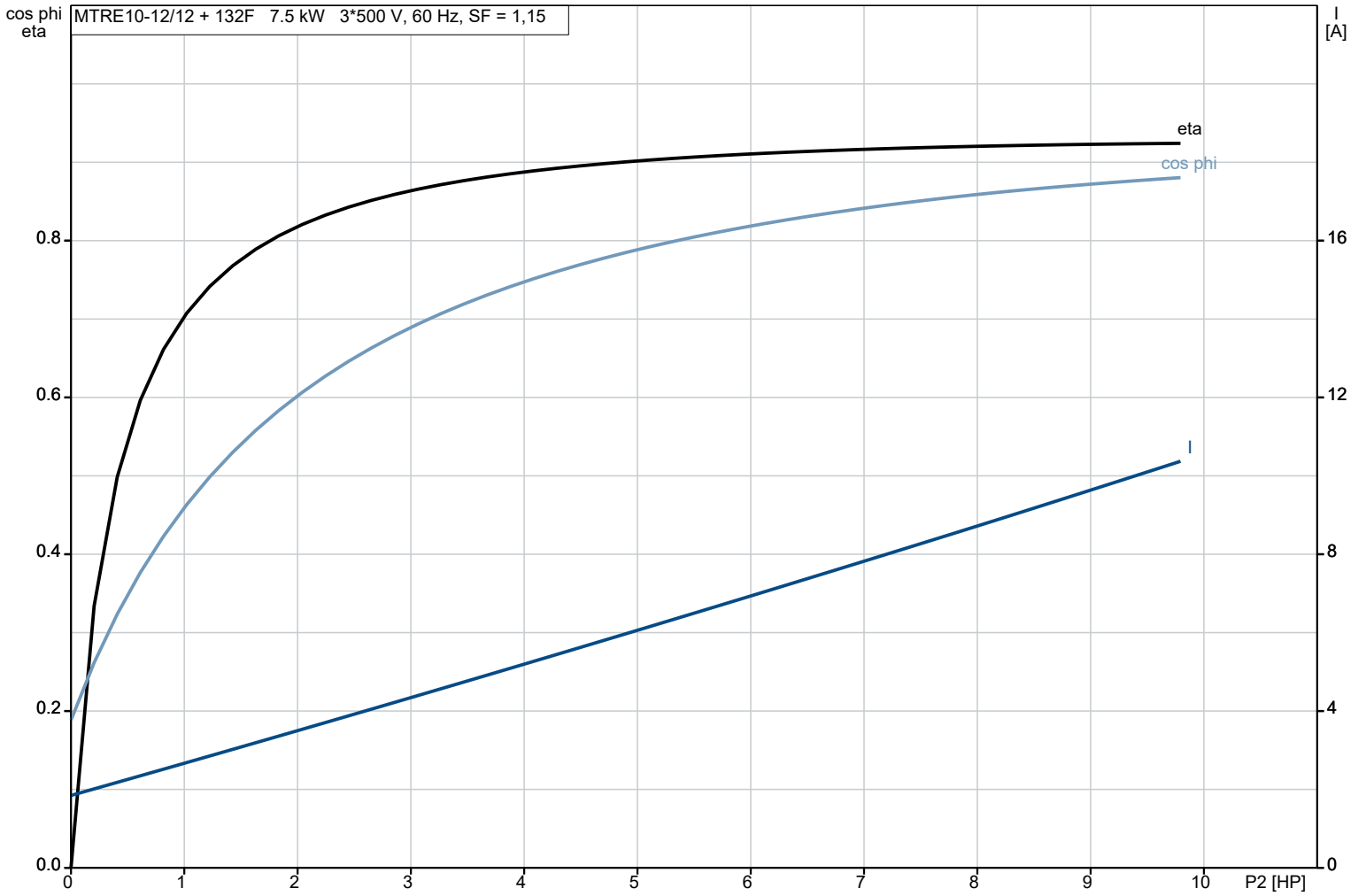

99077587 MTRE 10-12/12 A-WB-A-HUUV 60 Hz

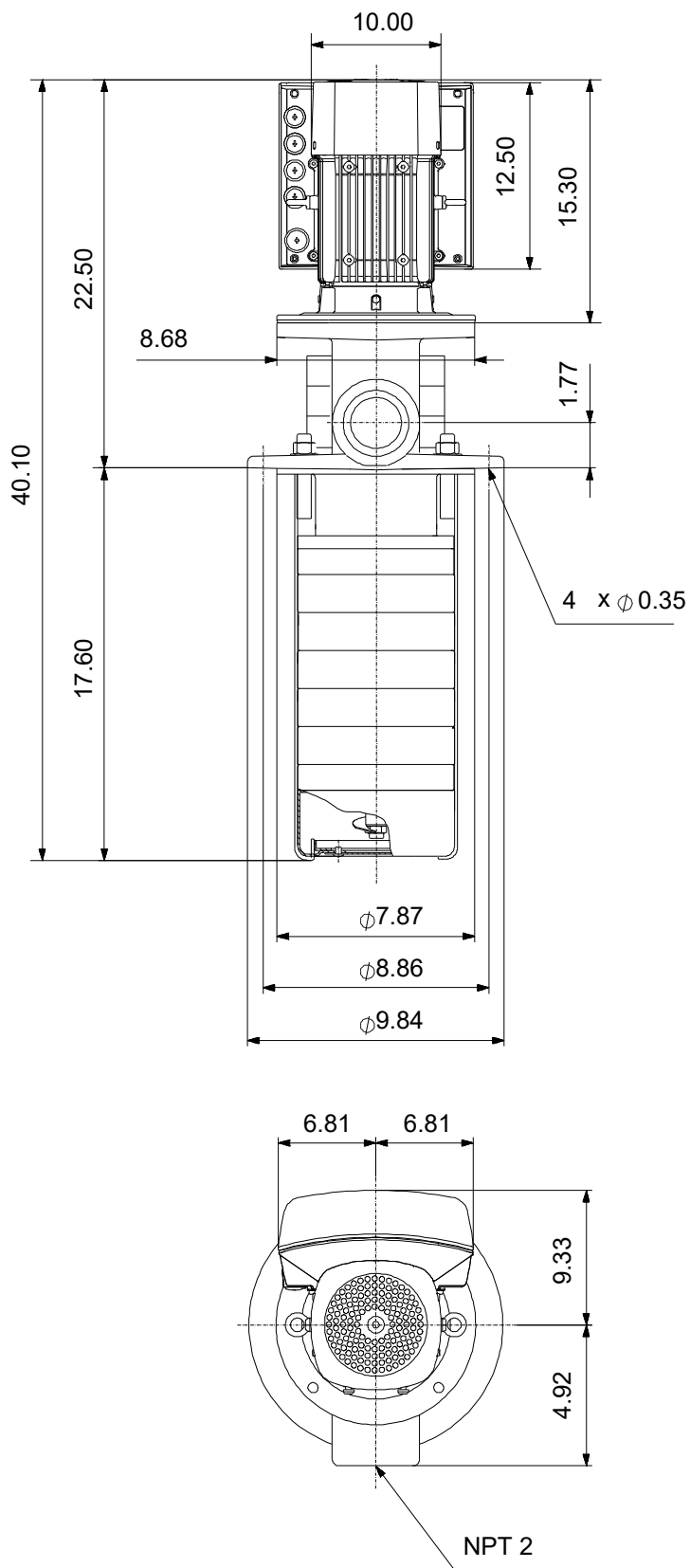

99077587 MTRE 10-12/12 A-WB-A-HUUV 60 Hz

