

EWP-L SERIES SPECIFICATIONS



Engineered for both reliability and versatility, the **EWP-L** features external analog and simple digital pulse input control as well as manual control with an 1800:1 turndown ratio. Its high-speed 360 strokes-per-minute operation ensures consistent performance, while its robust priming capability and durable construction make it the optimal choice for any cost-effective, high-precision chemical injection applications.

Simple operation and adjustment with two control knobs, flowrates up to 6.7 GPH (25 l/h) and pressure capability to 175 psi (12 bar) enable the EWP-L to easily fit into most applications.

Flexible Installation

An optional quick-access mounting base enables the EWP-L to be easily wall mounted or quickly removed from an installation without the need for tools.

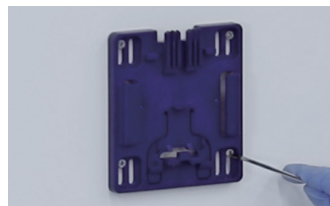

Rugged Housing

The EWP Series pumps are sealed and rated to an IP66 protection class (water and dust-proof) even without the chemical splash guard.



WALCHEM

IWAKI America Inc.

EWP MODEL IDENTIFICATION

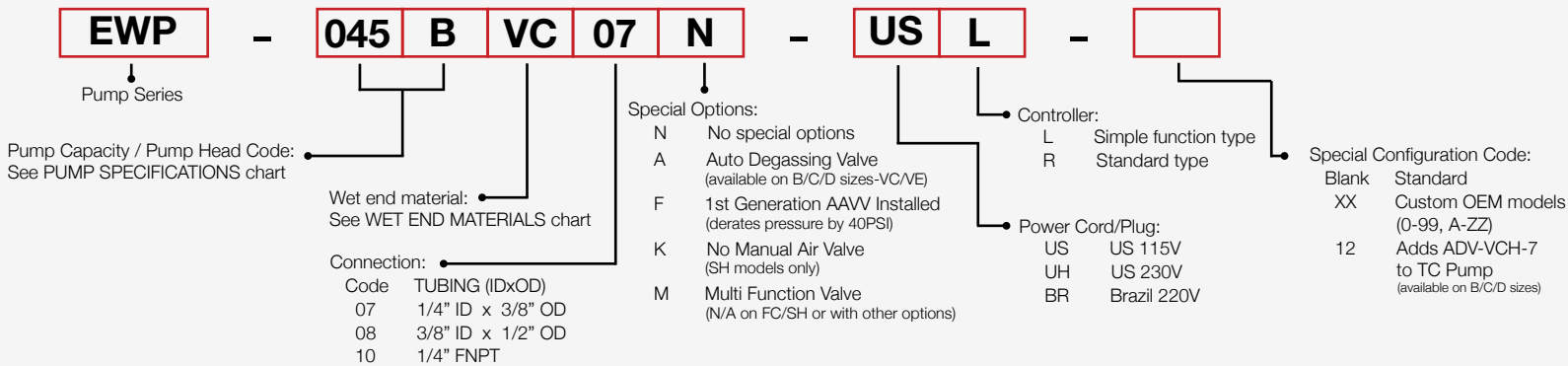

PUMP SPECIFICATIONS

	Pump Capacity	Pump Head Code	Capacity		Pressure		Special Options	MAX SPM	Wet End
			mL/Min	GPH	MPa	PSI			
Standard Models	025	A	25	0.4	1.2	175	N	360	VC/VE/VF
	045	B	45	0.7	1.0	150	N/F	360	VC/VE/VF/PC/PA PE/FC/TC/SH
	075	C	75	1.2	0.7	105	N/F	360	
	125	D	125	2.0	0.4	60	N/F	360	
	265	E	265	4.2	0.2	30	N	360	
	080	C	80	1.3	1.0	150	N/F	360	
	130	D	130	2.0	0.7	105	N/F	360	
	270	E	270	4.3	0.35	50	N	360	
	420	F	420	6.7	0.2	30	N	360	VC/VE/VF/PC/PA/PE
	420	F	410	6.5	0.2	30	N	360	TC/FC/SH
Auto-Degassing Valve	035	B	35	0.6	1.0	150	A	360	VC/VE
	055	C	55	0.9	0.7	105	A	360	
	085	D	85	1.4	0.4	60	A	360	
	064	C	64	1.0	1.0	150	A	360	
	110	D	110	1.7	0.7	105	A	360	

WET END MATERIALS

Code	Pump Head	Valve Balls	Valve Seat	O-ring	Gasket	Diaphragm
VC	PVC	CE	FKM	FKM	PTFE	PCTFE (bonded to EPDM)
VE			EPDM	EPDM		
VF		PTFE				
PC	GFRPP	CE	FKM	FKM		
PE			EPDM	EPDM		
PA			PCTFE	AFLAS		
TC			FKM	FKM		
TA	PVDF	CE	PCTFE	AFLAS		
FC						
SH				316SS		

CE	Alumina ceramic	GFRPP	Glass Fiber Reinforced Polypropylene
FKM	Fluoroelastomer	PVC	Polyvinylchloride (translucent)
PTFE	Polytetrafluoroethylene	HC	Hastelloy C276
PVDF	Polyvinylidene Fluoride	316SS	Stainless Steel
EPDM	Ethylene propylene diene monomer	AFLAS	Ethylene propylene diene monomer



The EWP metering pumps are tested by Intertek to UL and CSA standards.

ELECTRICAL SPECIFICATIONS

EWP-L	EWP-L (B)	EWP-L (C-F)
50/60 Hz, single phase	13 Watt avg.	23 Watt avg.
115 VAC \pm 10%	0.8 Amp max.	1.1 Amp max.
230 VAC \pm 10%	0.4 Amp max	0.5 Amp max.

SHIPPING WEIGHT	Approx. 9 lbs. (4.1 kg) (Plastic liquid ends)	Approx. 11 lbs. (5 kg) (Stainless Steel liquid ends)
-----------------	--	---

OPERATING CONDITIONS

Ambient Temperature:	32 to 122°F (0 to 50°C)	
Liquid Temperature:	PVC liquid ends:	32 to 104°F (0 to 40°C)
	PP, PVDF, SS liquid ends:	32 to 140°F (0 to 60°C)
	Below 32°F (0°C), pump is limited to 70% of maximum pressure.	
	Liquid cannot freeze.	
Relative Humidity:	30% to 90% non-condensing	

Pumps should always be shielded from direct exposure to the elements.

CONTROLLER SPECIFICATIONS

Controller Type		EWP-L
Operation mode	MAN	0-100% stroke rate ^{Note1} (Max. 360spm)
	EXT	4-20 mA in proportion to 0-360 spm
		0-6 Hz in synchronous with 0-360 spm
	Status LED	Red LED: Flashes when in EXT mode.
	LED	Green LED: Blinks synchronously with stroke when the pump is running. Red LED: Lights when a STOP signal is input.
Dial	Simple function dial (Stroke rate. PLS/ANA mode selector)	
Control functions	STOP	Pump stops when STOP signal input.
Input	Pulse	Dry contact or open collector ^{Note2}
	Analogue	4-20 mADC (Input resistance 220 Ω)
	STOP	Dry contact or open collector ^{Note2}
Power Voltage		100 240 VAC 50/60 Hz ^{Note3}

Note 1: Use the stroke rate adjusting dial to change the operation functions.
Dial scale is approximate for reference only.

Note 2: The maximum applied voltage to the contact is 5 VDC at 2.3 mA.
The minimum application load of the relay or switch should be 1 mA or below.

Note 3: Observe the specified power voltage range or failure may result.
The allowable power voltage range is 90–264 VAC.



EWP-L
Dimensions in mm

(VC/VS/VE/PC/PS/PE/TC)

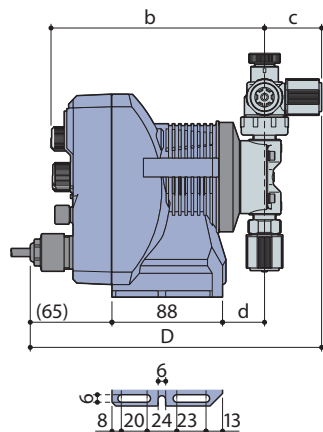

(FC)

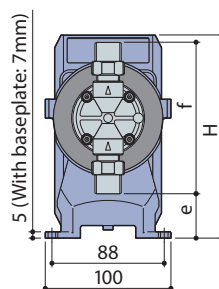
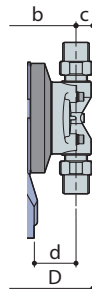
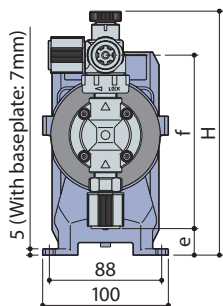

(SH)

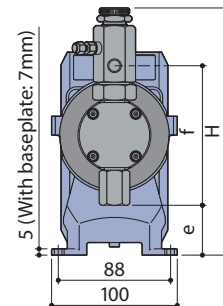
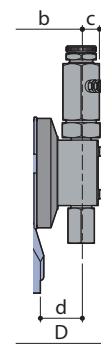

- Illustration shows 038B, 080C, 130D
- The EWP-SH type is heavy, so a base plate is used. With baseplate: 7mm

(VC/VS/VE/PC/PS/PE/TC)

Model	(H)	(D)	(a)	(b)	(c)	(d)	(e)	(f)
EWP-038B								
EWP-080C	194	233		170	47	33	20	139
EWP-130D			—					
EWP-270E	207	235		172	47	35	4	168
EWP-420F	206		5	166				

(FC)

Model	(H)	(D)	(a)	(b)	(c)	(d)	(e)	(f)
EWP-038B								
EWP-080C	162	199		170	13	33	35	121
EWP-130D			—					
EWP-270E	173	204		172	16	35	19	154
EWP-410F			171					

(SH)

Model	(H)	(D)	(a)	(b)	(c)	(d)	(e)	(f)
EWP-038B								
EWP-080C	197	204		170	15	32	40	111
EWP-130D			—					
EWP-270E	209	205		170	15	34	30	133
EWP-410F	211	207					27	138

Notes:

1. The Multifunction valve increases the overall length (D) by 2.5mm, the discharge height (f) by 66.5mm, and the overall height (H) by 31.8mm.
2. The Auto-Degassing valve increases the overall height (H) and the discharge height (f) by 45.9mm