

Iwaki

Electromagnetic Metering Pump

EWP-R (North America)

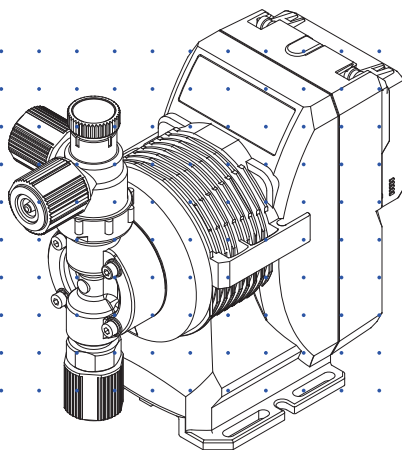

Instruction manual

Thank you for choosing our product.



Please read through this instruction manual before use.

This instruction manual describes important precautions and instructions for the product. Always keep it on hand for quick reference.



Veuillez lire attentivement ce mode d'emploi avant toute utilisation.

Ce manuel d'instructions décrit les précautions et instructions importantes pour le produit. Gardez-le toujours à portée de main pour consultation rapide.

Order confirmation

Open the package and check that the product conforms to your order. If any problem or inconsistency is found, immediately contact your distributor.

a. Check if the delivery is correct

Check the nameplate to see if the information such as model codes, discharge capacity and discharge pressure are as ordered.

Iwaki Metering Pump		FREQUENCY	Hz
MODEL		MFG.No.	
PRESSURE	PSI	Year	
CAPACITY	GPH	Thermal Protected	
		Acceptable for indoor use only	
VOLTAGE	V	Enclosure type 2	
CURRENT	A	Utilization in indoor use only	
		Nonsubmersible Pump	
IWAKI CO., LTD. (INCORPORATED IN JAPAN) 1-1-1, Nishiku, Tokyo, Japan		IP66	Intertek 3111327
		Certified to CAN/CSA S52.22 No.108	PM16-2

b. Check accessories are complete

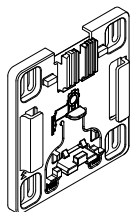

A detachable pump base

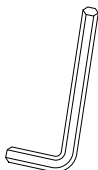

A 3mm or 4mm hex wrench



Two baseplates
(SH type)

c. Check if the delivery is damaged or deformed

Check for transit damage and loose bolts.

Contents

Order confirmation.....	2
-------------------------	---

Safety instructions/Consignes de sécurité	8
--	----------

WARNING / AVERTISSEMENT	10
-------------------------------	----

CAUTION / ATTENTION.....	12
--------------------------	----

Precautions for use / Précautions d'utilisation	16
---	----

Overview.....	20
----------------------	-----------

Introduction	20
---------------------------	-----------

Pump structure & Operating principle	20
--	----

Features.....	21
---------------	----

Part names	22
-------------------------	-----------

Pump.....	22
-----------	----

Operational panel	23
-------------------------	----

■ Display	23
-----------------	----

■ Basic displays & Pump states.....	24
-------------------------------------	----

Identification codes	26
-----------------------------------	-----------

Pump.....	26
-----------	----

Operational functions	28
------------------------------------	-----------

Manual mode	28
-------------------	----

EXT mode.....	28
---------------	----

■ ANA.P (analog preset) control.....	28
--------------------------------------	----

■ ANA.V (analog variable) control.....	29
--	----

■ PLS.V (pulse variable) control	30
--	----

■ DIV (divisor) control	31
-------------------------------	----

■ MULTI (multiplier) control.....	31
-----------------------------------	----

■ BATCH control	32
-----------------------	----

■ INT.B (interval batch) control	34
--	----

AUX function.....	34
Priming function.....	35
Control functions.....	35
■ STOP function	35
■ Pre-STOP function	36
■ Interlock function	37
Output functions	37
■ Pump out.....	37
■ Alarm out	37
■ State out.....	37
Other functions	38
■ Calibration.....	38
■ Keypad lock	38
■ Factory default setting	38
■ Anti-chattering factor	38
■ Input/Output logic	38

Installation **39**

Pump mounting	39
Floor mount.....	39
■ Mounting on the detachable pump base	39
■ Mounting on the floor (without pump base)	41
Wall mount.....	42
Plumbing	44
Tube connection	44
Thread connection.....	46
Check valve/Back pressure valve mounting.....	47
Wiring	49
End terminals.....	49
Power voltage/Earthing	50
■ Pump with the "US" or "UH" power plug codes.....	50
Signal wire connection.....	52
■ EXT IN/OUT	54

■ EXT IN	55
----------------	----

Operation.....56

Before operation.....	56
Points to be checked	56
Retightening of head bolts	56
■ Use of hex wrench instead of a torque wrench	57
Degassing.....	58
■ EWP VC/VS/VE/PC/PS/PE/TC/SH with the MAN air vent port.....	58
■ EWP FC with no MAN air vent port	61
Flow rate adjustment	64
■ Stroke rate adjustment.....	66
■ Stroke length adjustment	67
Perform a calibration	68
Before a long period of stoppage (one month or more).....	69
Operation programming.....	70
Programming flow.....	72
Manual operation.....	73
EXT operation.....	74
■ EXT control mode.....	74
AUX function.....	76
Priming function.....	76
Keypad lock	76
■ Keypad lock activation	76
■ Keypad lock release	77
■ Emergency stop with keypads locked.....	77
Unit change.....	78
■ Stroke rate unit.....	78
■ Flow rate unit	78
Menu mode.....	79

EXT mode setting	80
■ Flow chart	80
■ EXT mode setting	82
Calibration.....	92
Input setting	93
Output setting (photocoupler: open collector)	94
■ Target setting	95
■ Alarm setting.....	96
Data logging.....	97
Other setting	98
■ Flow chart	98
■ Other setting	100

Maintenance..... 107

Troubleshooting	108
Inspection	109
Daily inspection	109
Periodic inspection	109
Wear part replacement	110
Wear part list.....	110
Before replacement	111
Valve set replacement	111
■ Discharge valve set disassembly/assembly	111
■ Suction valve set disassembly/assembly	116
Diaphragm replacement	117
Exploded view	120
Pump head, Drive unit & Control unit	120
Pump head	121
■ EWP-038B/-130D/-270E/-410F/-420F VC/VS/VE/PC/PS/PE/TC.....	121
■ EWP-038B/-080C/-130D/-270E/-410F FC	122
■ EWP-038B/-080C/-130D/-270E/-410F SH.....	123
Specifications/Outer dimensions.....	124

Specifications	124
■ Pump unit.....	124
■ Control unit	125
■ Power cable	126
■ Pump color.....	126
Outer dimensions.....	127
■ EWP-038B/-080C/-130D/-270E/-410F/-420F VC/VS/VE/PC/PS/PE/TC	127
■ EWP-038B/-080C/-130D/-270E/-410F FC	128
■ EWP-038B/-080C/-130D/-270E/-410F SH.....	129
Anchorage points guide (Wall-mount use of the pump base)	130

Safety instructions/Consignes de sécurité

Read through this section before use. This section describes important information for you to prevent personal injury or property damage.

Veillez lire attentivement cette section avant toute utilisation. Elle fournit d'importantes informations visant à empêcher toute blessure corporelle ou tout dommage matériel.

■ Symbols / Symboles

In this instruction manual, the degree of risk caused by incorrect use is noted with the following symbols. Please pay attention to the information associated with the symbols.

Dans le présent manuel d'instructions, le degré de risque lié à une utilisation incorrecte de l'équipement est indiqué par les symboles suivants. Veuillez prêter attention aux informations associées à chaque symbole.

WARNING

Indicates mishandling could lead to a fatal or serious injury accident.

AVERTISSEMENT

Indique que toute erreur de manipulation peut conduire à un accident entraînant de graves blessures corporelles ou la mort.

CAUTION







Indicates mishandling could lead to personal injury or property damage.

ATTENTION

Indique que toute erreur de manipulation peut conduire à des blessures corporelles ou à des dommages matériels.

A symbol accompanies each precaution, suggesting the use of "Caution", "Prohibited actions" or specific "Requirements".

Chaque mesure de sécurité est accompagnée d'un symbole, qui indique un "Avertissement", des "Actions interdites" ou une "Exigence" particulière.

Caution marks / Symbole d'avertissement		Prohibited marks / Symbole d'interdiction		Requirement marks / Symbole d'exigence		
						
Caution	Electrical shock	Prohibition	Do not remodel	Requirement	Wear protectors	Grounding
Attention	Électrocution	Interdiction	Ne pas remanier	Exigence	Porter des EPI	Mise à la terre

Export Restrictions / Restrictions à l'exportation

Technical information contained in this instruction manual might be treated as controlled technology in your countries, due to agreements in international regime for export control.

Please be reminded that export license/permission could be required when this manual is provided, due to export control regulations of your country.

Les informations techniques contenues dans le présent manuel d'instructions peuvent être considérées dans vos pays comme une technologie contrôlée, en raison d'accords dans le cadre du régime international pour le contrôle des exportations.

Veuillez garder à l'esprit qu'un permis/une licence d'exportation peut être nécessaire pour la fourniture du présent manuel d'instructions, en raison de la réglementation relative au contrôle des exportations de votre pays.

WARNING / AVERTISSEMENT

Turn off power before service

Risk of electrical shock. Be sure to turn off power to stop the pump and related devices before service is performed.

Couper l'alimentation électrique de la pompe avant intervention

Intervenir sur la pompe sans avoir au préalable coupé l'alimentation électrique peut déclencher des décharges électriques. Avant d'entreprendre n'importe quel type d'intervention, veillez à mettre la pompe et tout dispositif connexe hors tension à l'aide de l'interrupteur prévu à cet effet.



Stop operation

If you notice any abnormal or dangerous conditions, suspend operation immediately and inspect/solve problems.

Arrêter le fonctionnement

Si vous détectez une anomalie ou des signes suspects et inhabituels pendant le fonctionnement, interrompez immédiatement les opérations et inspectez, résolvez les problèmes.



Do not use the pump in any condition other than its intended purpose

The use of the pump in any conditions other than those clearly specified may result in failure or injury. Use this product in specified conditions only.

Se conformer uniquement aux applications prévues

La pompe doit être utilisée conformément à l'usage pour lequel elle a été prévue et dans le respect de ses caractéristiques techniques. Toute utilisation non conforme peut entraîner un incident ou endommager le dispositif.



Do not modify the pump

Alterations to the pump carries a high degree of risk. It is not the manufacturer's responsibility for any failure or injury resulting from alterations to the pump.

Ne pas modifier la pompe

Ne jamais modifier une pompe sous peine de causer un incident grave. Iwaki ne pourra en aucun cas être tenu responsable d'un incident ou de dégâts survenus à la suite d'une modification du dispositif.



Wear protective clothing

Always wear protective clothing such as an eye protection, chemical resistant gloves, a mask and a face shield during disassembly, assembly or maintenance work. The specific solution will dictate the degree of protection. Refer to SDS precautions from the solution supplier.



Wear protectors
Porter des EPI

Porter un équipement de protection

Toujours porter un équipement de protection (lunettes, gants résistants aux produits chimiques, masque, casque) durant le démontage, l'assemblage et la maintenance.

Le travail effectué dictera le degré de protection. Référez-vous au SDS de la solution proposée par le fournisseur.

Do not damage the power cable

Do not pull, knot, or crush the power cable. Damage to the power cable could lead to a fire or electrical shock if cut or broken.



Prohibition
Interdiction

Ne pas endommager le câble électrique

Ne pas tirer ou faire un nœud avec le câble électrique. Endommager un câble électrique peut provoquer un incendie ou une décharge électrique.

Do not operate the pump in a flammable atmosphere

Do not place explosive or flammable material near the pump.



Prohibition
Interdiction

Ne pas utiliser la pompe dans une atmosphère explosive

Pour votre sécurité, du matériel dangereux ou inflammable ne doit pas être placé près de la pompe.

Risk of electric shock

This pump is supplied with a grounding conductor and ground-ing-type attachment plug. To reduce the risk of electric shock, be certain that it is connected only to a properly grounded, grounding type receptacle.



Prohibition
Interdiction

Risque de choc électrique

La pompe est fournie avec un conducteur pour mise à la terre et une prise courant. Afin de réduire le risque de choc électrique, veillez à ce que la terre soit correctement raccordée.

Qualified personnel only

The pump should be handled or operated by qualified personnel with a full understanding of the pump. Any person not familiar with the product should not take part in the operation or maintenance of the pump.

Opérateur qualifié uniquement

La pompe doit être manipulée ou utilisée par du personnel qualifié connaissant parfaitement la pompe. Tout autre personne étrangère ne doit pas prendre part à l'utilisation ou à la maintenance de la pompe.



Requirement
Exigence

Use specified power only

Do not apply power other than that specified on the nameplate. Otherwise, failure or fire may result. Ensure the pump is properly grounded.

Utilisez une tension appropriée uniquement

Ne pas appliquer une autre tension que celle spécifiée sur la plaque signalétique sinon, il peut en résulter une panne ou une incendie. Assurez-vous également de la mise à la terre de la pompe.



Prohibition
Interdiction

Do not run pump dry

Do not run pump dry for more than 30 minutes (even when the pump runs for degassing). Otherwise, the pump head fixing screws may loosen and liquid may leak. Optimize your system. If the pump runs dry for a long period (for more than 30 minutes), the pump head and the valve cases may deform by friction heat and consequently leakage results.

Ne faite pas fonctionner la pompe à sec

Ne faite pas fonctionner la pompe à sec plus de 30 minutes (même lorsque la pompe fonctionne pour dégazer). Sinon, les visse de fixation de la tête peuvent se dévisser et il peut y avoir une fuite de liquide. Optimalisez l'installation de façon à ce que la pompe ne fonctionne pas à sec. Si la pompe fonctionne à sec pour une longue période (plus de 30 minutes), la tête de la pompe et le guide de clapets peuvent être déformés par friction causée par la chaleur et il en résulterait des fuites.



Caution
Attention

Keep electric parts and wiring dry

Risk of fire or electric shock. Install the pump where it can be kept dry.

Ne mouillez pas les parties électriques ou les câbles

Risque d'incendie ou de décharge électrique. Installez la pompe dans un endroit sec.



Prohibition
Interdiction

Ventilation

Fumes or vapors can be hazardous with certain solutions. Ensure proper ventilation at the operation site.

Ventilation

Manipuler un produit toxique ou odorant peut provoquer une intoxication. Prévoyez une ventilation suffisante à l'endroit de la manipulation.



Caution
Attention

Do not install or store the pump:

- In a flammable atmosphere.
- In a dusty/humid environment.
- Where ambient temperature can exceed 32-104°F (0-40°C).
- In direct sunlight or wind & rain.

N'installez ou ne stockez pas la pompe dans les endroits suivantes:

- Dans une atmosphère inflammable
- Dans un endroit poussiéreux ou humide.
- Dans une place où la température n'est pas comprise entre 0 et 40 °C.
- Directement sous le soleil, le vent ou la pluie.



Prohibition
Interdiction

Spill precautions

Ensure protection and containment of solution in the event of plumbing or pump damage (secondary containment).

Déversement accidentel

Prenez des mesures protectrices contre tout incident résultant d'un débit trop important de la pompe ou d'une casse de tuyauterie.



Requirement
Exigence

Do not use the pump in a wet location

The pump is not waterproof. Use of the pump in wet or extremely humid locations could lead to electric shock or short circuit.



Prohibition
Interdiction

N'utilisez pas la pompe sous l'eau

La pompe n'est pas complètement étanche. Utiliser la pompe dans l'eau ou dans un endroit très humide peut créer une décharge électrique ou un court-circuit.

Grounding

Risk of electrical shock! Always properly ground the pump. Conform to local electric codes.



Grounding
Mise à la terre

Mise à la terre

Veillez à ne pas faire fonctionner la pompe sans avoir au préalable prévu une mise à la terre. Celle-ci permettra d'éviter d'éventuelles décharges électriques. Vérifiez que le câble de mise à la terre est bien branché.

Install a GFCI (earth leakage breaker)

An electrical failure of the pump may adversely affect other devices on the same line. Purchase and install a GFCI (earth leakage breaker) separately.



Electrical
shock
Électrocution

Détecteur de fuites à la terre

Un problème électrique peut affecter défavorablement le dispositif. Achetez et installez un détecteur de fuites à la terre.

Preventative maintenance

Follow instructions in this manual for replacement of wear parts. Do not disassemble the pump beyond the extent of the instructions.



Requirement
Exigence

Remplacement des pièces usées

Suivez les instructions de ce manuel pour remplacer les pièces usées. Ne démontez pas la pompe au-delà des instructions.

Do not use a damaged pump

Use of a damaged pump could lead to an electric shock or death.



Prohibition
Interdiction

N'utilisez pas une pompe endommagée

Utiliser une pompe endommagée peut provoquer une décharge électrique ou la mort.

Disposal of a used pump

Dispose of any used or damaged pump in accordance with local rules and regulations. If necessary, consult a licensed industrial waste disposal company.



Requirement
Exigence

Elimination des pompes usées

Elle doit se faire en conformité avec les règles locales en vigueur (consultez une entreprise certifiée et spécialisée).

Check pump head bolts

Liquid may leak if any of the pump head bolts become loose. Tighten the bolts evenly to the following torque in diagonal order before initial operation and at regular intervals.

Tightening torque

EWP-038B/-080C/-130D/-270E:	19 lb-in	M4 hex socket bolt
EWP-410F/-420F	: 22.6 lb-in	M5 hex socket bolt



Caution
Attention

Serrez la tête de pompe

La pompe peut fuiter si les boulons sont desserrés. Resserrez les boulons diagonalement et uniformément avant la première utilisation Resserrez les boulons régulièrement pour éviter tout fuite.

Couple de serrage

EWP-038B/-080C/-130D/-270E :	19 lb-in	M4 boulon à tête hexagonale
EWP-410F/-420F	: 22.6 lb-in	M5 boulon à tête hexagonale

Install a relief valve

Install a relief valve on a discharge line near the pump so as to automatically release the discharge pressure when it exceeds the maximum level.

Installer une soupape de décharge

Installez une soupape de décharge sur la conduite de refoulement à proximité de la pompe de manière à relâcher automatiquement la pression au refoulement lorsqu'elle dépasse le seuil maximal.



Requirement
Exigence

Precautions for use / Précautions d'utilisation

- Electrical work should be performed by a qualified electrician. Otherwise, personal injury or property damage could result.

Le raccordement électrique de la pompe doit être effectué par du personnel qualifié sinon, il pourrait y avoir un dommage corporel ou incorporel.



Caution
Attention

- Do not install the pump:
 - In a flammable atmosphere.
 - In a dusty/humid place.
 - In direct sunlight or wind & rain.
 - Where ambient temperature can exceed 32-104°F (0-40°C).

Protect the pump with a cover when installing it out of doors.

Ne pas installer la pompe dans les endroits suivants:

- Dans une atmosphère inflammable
- Dans une atmosphère poussiéreuse ou humide.
- Sous les rayonnements du soleil, dans le vent ou sous la pluie.
- La température ambiante doit être comprise entre 0 et 40°C.

Protégez la pompe par un capot si vous l'installez dehors.



Caution
Attention

- Select a level location, free from vibration, that won't hold liquid. Anchor the pump with four M5 bolts so it doesn't vibrate. If the pump is not installed level, output may be affected.

Choisissez un endroit où il n'y a pas de vibrations et où le liquide peut s'évacuer. Fixez la pompe à l'aide de vis M5 de façon à ne pas avoir de vibrations. Si la pompe est inclinée, le débit peut être réduit.



Requirement
Exigence

- When two or more pumps are installed together, vibration may be significant, resulting in poor performance or failure. Select a solid foundation (concrete) and fasten anchor bolts securely to prevent vibration during operation.

Si plusieurs pompes sont installées ensemble, elles interagissent et les vibrations peuvent devenir importantes, ce qui engendre des performances médiocres ou des ratures. Choisissez un endroit solide et fixez les boulons correctement pour éviter les vibrations pendant le fonctionnement.



Requirement
Exigence

- Allow sufficient space around the pump for easy access and maintenance.

Prévoyez de l'espace autour de la pompe pour faciliter l'accès et la maintenance.



Caution
Attention

- Install the pump as close to the supply tank as possible.

Installez la pompe le plus près possible du tank de produit.



Requirement
Exigence

- When handling liquids that generate gas bubbles (sodium hypochlorite or hydrazine solution), install the pump in a cool and dark place. Flooded suction installation is strongly recommended.

Installez la pompe dans une place froide à l'abri du soleil lorsqu'il s'agit du dosage de produits dégazant tels que l'hypochlorite de sodium ou l'hydrazine. Mettre la pompe en charge est vivement recommandé.



Requirement
Exigence

- Use care handling the pump. Do not drop. An impact may affect pump performance. Do not use a pump that has been damaged to avoid the risk of electrical damage or shock.

Veillez à ne pas laisser tomber la pompe sur le sol. Un impact important pourrait réduire les performances de la pompe. Ne pas utiliser une pompe endommagée sinon il pourrait y avoir un courant de fuite ou une décharge électrique.



Prohibition
Interdiction

- The pump has a rating of IP66, but is not waterproof. Do not operate the pump while wet with solution or water. Failure or injury may result. Immediately dry off the pump if it gets wet.

Le pompe est IP66 mais n'est pas complètement étanche. Ne pas laisser la pompe couverte de liquide pompé ou sous la pluie. Il pourrait y avoir des ratés ou préjudices. Si la pompe a été mouillée, sechez-la directement.



Caution
Attention

- Do not close discharge line during operation. Solution may leak or piping may break. Install a relief valve to ensure safety and prevent damaged plumbing.

Ne fermez pas la ligne de refoulement lorsque la pompe est en fonctionnement sinon il pourrait y avoir des fuites de liquide ou la tuyauterie pourrait céder. Installez une soupape de sécurité pour des raisons de sécurité et pour éviter tout dommage de la tuyauterie.



Caution
Attention

- Solution in the discharge line may be under pressure.
Release the pressure from the discharge line before disconnecting plumbing or disassembly of the pump to avoid solution spray.

Le liquide au refoulement peut être sous pression.
Relâchez la pression du refoulement avant de démonter la pompe ou d'enlevez le tubage pour éviter tout jet de liquide.



Requirement
Exigence

- Wear protective clothing when handling or working with pumps. Consult solution SDS for appropriate precautions. Do not come into contact with residual solution.

Portez un équipement de sécurité lorsque vous manipulez la pompe. Consultez le SDS pour utilisez les précautions appropriées. Evitez tout contact avec le liquide chimique.



Caution
Attention

- Do not clean the pump or nameplate with a solvent such as benzine or thinner. This may discolor the pump or erase printing. Use a dry or damp cloth or a neutral detergent.

Ne nettoyez pas la pompe ni la plaque signalétique à l'aide d'un solvant comme du benzine ou du diluant. Cela risque de décolorer la pompe ou d'effacer des données inscrites dessus. Utilisez un chiffon sec ou humide, ou un détergent neutre.



Prohibition
Interdiction

- This pump has been evaluated for use with water only.

Cette pompe a été testée uniquement avec de l'eau.



Caution
Attention

Overview

Pump characteristics, features and part names are described in this section.

Introduction

Pump structure & Operating principle

The EWP series is a diaphragm metering pump which consists of a pump head, a drive unit, and a control unit. A diaphragm is directly driven by electro-magnetic force.

Principle of operation

The pulse signal via the control unit generates the electromagnetic force to make reciprocating motion with the assistance of the spring force. The reciprocating motion is transferred to the diaphragm through the shaft and then volumetric change occurs in the pump head. This action transfers liquid along with pump head valve action.

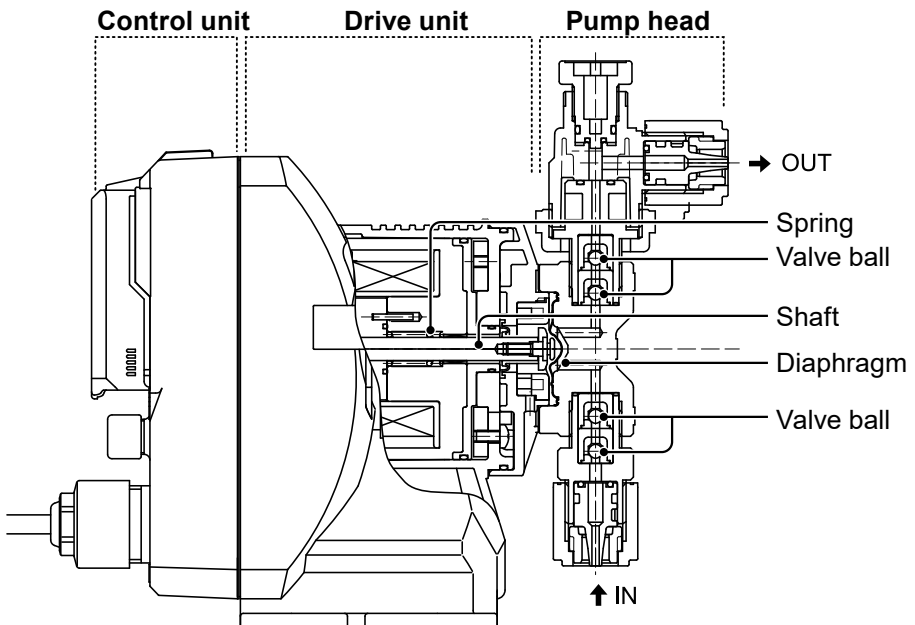

Features

- **Multivoltage operation**

The EWP series is a multivoltage type (100-240VAC) and can be selected without local power limitations.

- **High resolution flow adjustment**

A wide range, digitally-controlled, stroke rate adjustment of 0.1 to 100.0% with fine flow tuning (stroke length adjustment).

- **Waterproof and dustproof structure**

The sealed unit design assures a rating of IP66.

*Protect the pump with a cover when installing it out of doors.

- **Good visibility**

Offered with the negative backlight LCD. The auto-sleep display contributes to energy saving.

- **Status LED**

The Status LED on the controller tells you whether the pump is running, paused, or alarming.

- **Three proportional control modes**

The ANA.P (analog preset) control mode, ANA.V (analog variable), and PLS.V (pulse variable) regulate your pump corresponding to the internal pre-set/user patterns of the pump.

- **Four pulse control modes**

The DIV (divisor) control mode, MULTI (multiplier), BATCH (batch), and INT.B (interval batch) regulate your pump corresponding to the external signal from your device (e.g. paddlewheel flowmeter).

- **Highly-efficient solenoid**

Realizes higher energy saving and downsizing than ever before.

- **Wall-mountable design**

If necessary, use the separate pump base to mount the pump on the wall. (except the SH type that is too heavy to be mounted on the wall)

Part names

Pump

Spec label _____

Adjusting screw _____

Air vent port _____

Always connect a tube. Be sure to return the tube end to a supply tank or a container.

Outlet _____

Air vent body _____

Caution label _____

Pump head _____

Inlet _____

Base _____

Always fix with bolts.

Control unit _____

Used for the start/stop of the pump and stroke rate adjustment/programming.

Stroke length adjusting knob _____

Splash shield _____

Pumps with SH/FC wet ends _____

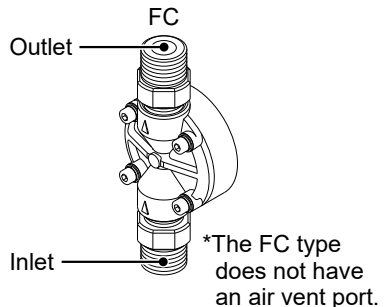
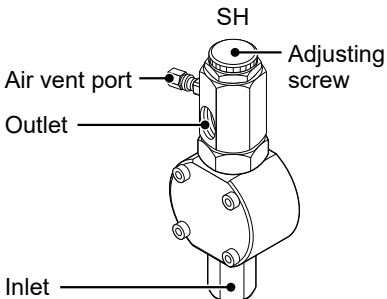

Operational panel

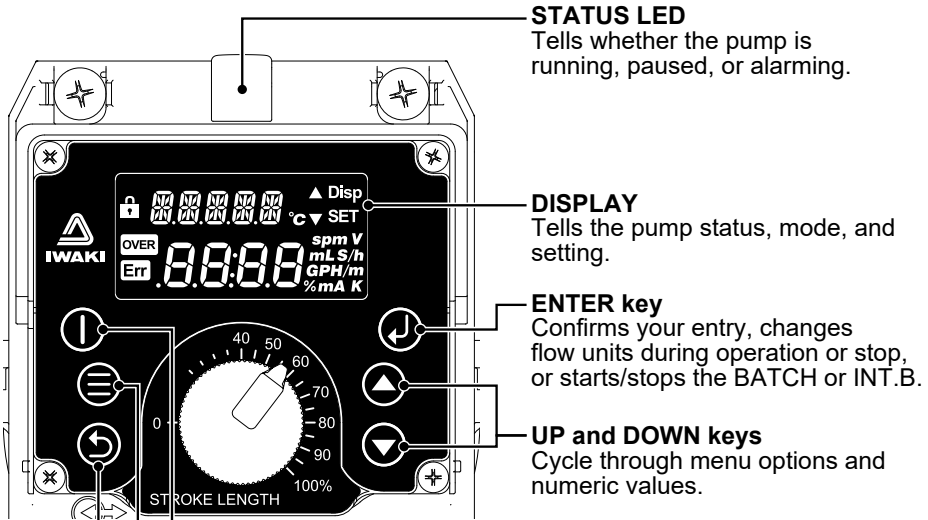

START/STOP key
Enters the MANUAL mode or the EXTERNAL mode. Pressing this key for 3 sec runs the pump at the priming speed only while the key is depressed (max 1 min).
*Pressing this key for 3 sec also stops the pump that has locked keypads.







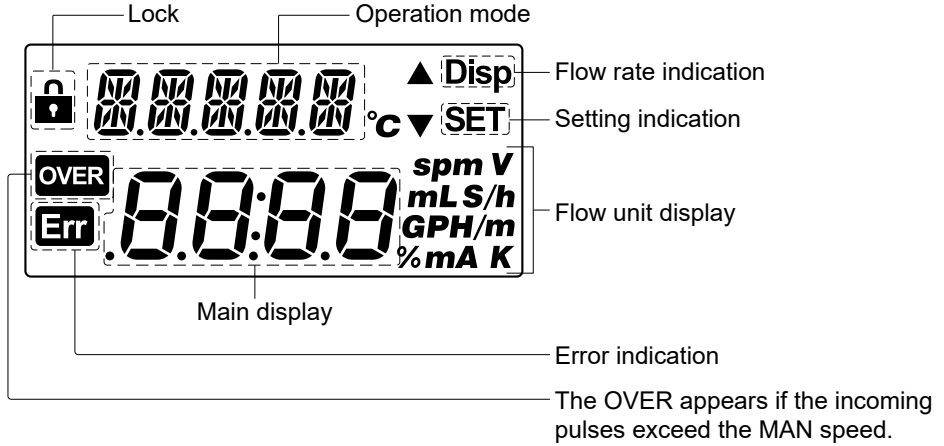



MENU key
Moves from the MAN/EXT selection mode to the Menu mode. Pressing this key for 3 sec in the MAN or EXT mode during operation or stop, the keypads are locked.
*However, keypads won't be locked in the Menu mode.





ESCAPE key
Moves back to the previous page.

■ Display



■ Basic displays & Pump states

Display	Status LED			
	Red	Green	Orange	White
	—	Blinks in the MAN RUN mode.	—	—
	—	Blinks in the EXT RUN. Lights in EXT WAIT mode.	—	—
	—	Blinks in AUX RUN mode.	—	—
	—	Blinks in PRIME RUN mode.	—	—
 ↑ Appears in turn 	—	—	When PreSTOP signal is input: -Blinks in MAN/EXT RUN. -Lights in MAN/EXT WAIT.	—
	—	—	—	Lights in MAN/EXT selection mode.
	—	—	—	Lights in MAN WAIT mode.
	—	—	—	Lights with the EXT WAIT mode.
	—	—	—	Lights in the MENU mode.

Display	Status LED			
	Red	Green	Orange	Purple
 <p>↑ Appears in turn</p> 	—	—	—	Lights whenever the STOP signal is input. (except prime mode)
 <p>↑ Appears in turn</p> 	Lights whenever the I.LOCK signal is input. (except prime mode)	—	—	—

Identification codes

The model codes of the pump represents the following information.

Pump

EWP - 038B VC 01 N - US R

a b c d e f g

a. Series name

EWP: Multivoltage electromagnetic metering pump

b. Pump unit

	Pump Capacity	Pump Head Code	Capacity		Pressure	
			mL/Min	GPH	MPa	PSI
Standard Models	025	A	25	0.4	1.2	175
	045	B	45	0.7	1.0	150
	075	C	75	1.2	0.7	105
	125	D	125	2.0	0.4	60
	265	E	265	4.2	0.2	30
	080	C	80	1.3	1.0	150
	130	D	130	2.0	0.7	105
	270	E	270	4.3	0.35	50
	420	F	420	6.7	0.2	30
	420*1	F	410	6.5	0.2	30
High Compression (with ADV)	020	B	20	0.3	1.0	150
	043	C	43	0.7	1.0	150
	062	D	62	1.0	0.7	105
High Pressure	038	B	38	0.6	2.0	290
Auto-Degassing Valve	035	B	35	0.6	1.0	150
	055	C	55	0.9	0.7	105
	085	D	85	1.4	0.4	60
	064	C	64	1.0	1.0	150
	110	D	110	1.7	0.7	105

*1 TA/TC/FC/SH only

c. Wet end materials

Code	Pump Head	Valve Balls	Valve Seat	O-ring	Gasket	Diaphragm
VC	PVC	CE	FKM	FKM	PTFE	PCTFE (bonded to EPDM)
VE			EPDM	EPDM		
VF		PTFE				
PC	GFRPP	CE	FKM	FKM		
PE			EPDM	EPDM		
PA			PCTFE	AFLAS		
TC	PVDF		FKM	FKM		
TA			PCTFE	AFLAS		
FC				—		
SH		316SS	HC	316SS		

Material code

CE	Alumina ceramic	GFRPP	Glass Fiber Reinforced Polypropylene
FKM	Fluoroelastomer	PVC	Polyvinylchloride (translucent)
PTFE	Polytetrafluoroethylene	HC	Hastelloy C-276
PVDF	Polyvinylidene difluoride	316SS	Stainless Steel
EPDM	Ethylene propylene diene monomer	AFLAS	Ethylene propylene diene monomer

d. Connection

Code	Tube I.D. × O.D.	Wet ends	Pump type
07	ø1/4"×ø3/8"	VC/VE/PC/PA/PE/TC/TA/FC	A/B/C/D
08	ø3/8"×ø1/2"		E/F
10	1/4" FNPT	SH	B/C/D/E/F
11	1/2" MNPT	PC/PS (HV only)	E

e. Special Options

N: No special options

C: High Compression (w/ADV)

A: Auto Degassing Valve (available on B/C/D sizes-VC/VE)

F: 1st Generation AAVV Installed (derates pressure by 40PSI)

H: High Pressure (290PSI) (available on 038B-PC/PE/PA/SH)

K: No Manual Air Valve (SH models only)

W: High Pressure & No Manual Air Valve (SH models only)

M: Multi Function Valve (N/A on FC/SH or with other options)

f. Voltage/Power Cord/Plug

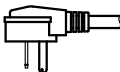
Code	Area	Power plug	Cable length
US	USA (115VAC)		78.74" (2000mm)
UH	USA (230VAC)		

g. Controller

R: Standard

- LCD Display & Keypad
- Multi-function and programmable control
- Output feedback/Alarm relay (programmable)

Operational functions

Manual mode

Run/stop the pump with the **ⓘ** key. A stroke rate (MAN speed) can be changed with the **⬆** and **⬇** keys at any time during operation or stop.

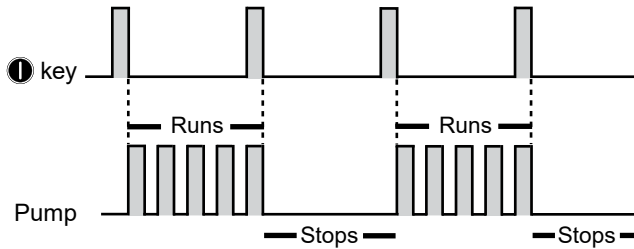

EXT mode

■ ANA.P (analog preset) control

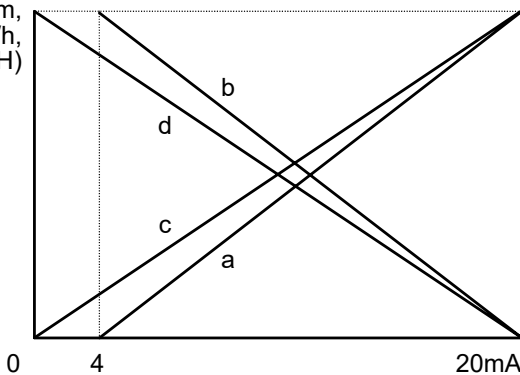

The pump increases/decreases a stroke/flow rate (between 0 and the maximum stroke rate of the pump that is user-settable) in proportion to 0-20mA current input. Four preset patterns (4-20mA, 20-4mA, 0-20mA, and 20-0mA) are provided. See page 82 for detail. To show the input current value (mA IN) during operation, push the **⬇** key. To return to the stroke rate or the flow rate display, push the **⬆** key.

100%/spm,
(mL/m, L/h,
or GPH)



Condition:
a. 4-20mA (default)
b. 20-4mA
c. 0-20mA
d. 20-0mA

■ ANA.V (analog variable) control

The pump increases/decreases a stroke/flow rate (between 0 and the maximum stroke rate of the pump that is user-settable) in proportion to 0-20mA. Determine the SP1 (setpoint 1) and SP2 (setpoint 2) and choose one of the LINE, BOX and LIMIT patterns. See page 84 for detail. To show the input current value (mA.IN) during operation, push the  key. To return to the stroke rate (spm) or the flow rate (%) display, push the  key.

<LINE>

A stroke/flow rate changes with a current value by a set line.

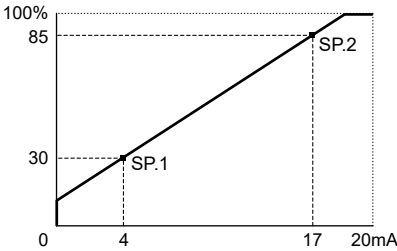

Condition:
 SP.1 = 4 mA, 30%
 SP.2 = 17 mA, 85%

<BOX>

A stroke/flow rate changes with a current value by a set line. The rate does not exceed the Set Point 2 but then falls to 0 before the Set Point 1.

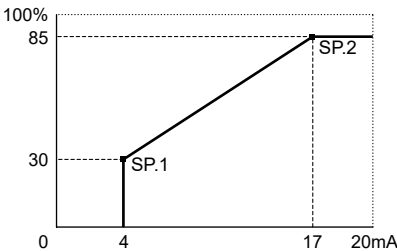

Condition:
 SP.1 = 4 mA, 30%
 SP.2 = 17 mA, 85%

<LIMIT>

A stroke/flow rate changes with a current value by a set line. The rate does not fall below the Set Point 1 or exceed the Set Point 2.

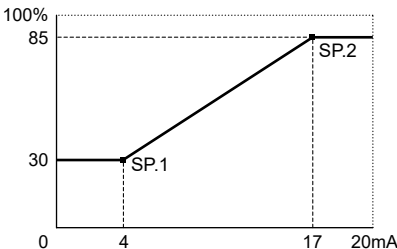

Condition:
 SP.1 = 4 mA, 30%
 SP.2 = 17 mA, 85%

■ PLS.V (pulse variable) control

The pump increases/decreases a stroke/flow rate (between 0 and the maximum stroke rate of the pump that is user-settable) in proportion to 0-100Hz (or 0-500Hz, user selectable). Determine the SP1 (setpoint 1) and SP2 (setpoint 2) and choose one of the LINE, BOX and LIMIT patterns. See page 86 as well.

<LINE>

A stroke/flow rate changes with a pulse rate by a set line.

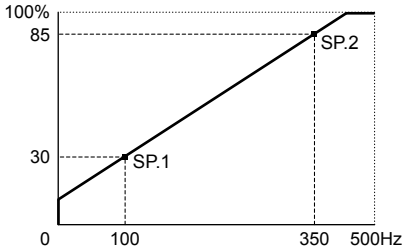

Condition:

SP.1 = 100Hz, 30%

SP.2 = 350Hz, 85%

<BOX>

A stroke/flow rate changes with a pulse rate by a set line. The rate does not exceed the Set Point 2 but then falls to 0 before the Set Point 1.

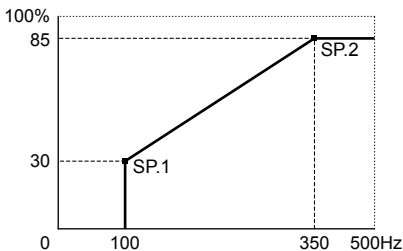

Condition:

SP.1 = 100Hz, 30%

SP.2 = 350Hz, 85%

<LIMIT>

A stroke/flow rate changes with a pulse rate by a set line. The rate does not fall below the Set Point 1 or exceed the Set Point 2.

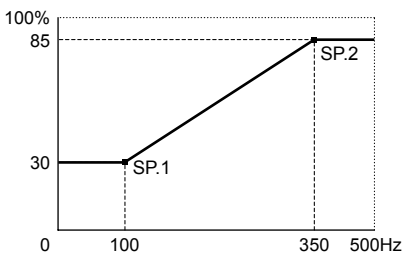

Condition:

SP.1 = 100Hz, 30%

SP.2 = 350Hz, 85%

■ DIV (divisor) control

The pump can accept a non-powered (dry contact) pulse signal from a flowmeter or other similar instrument. The pump can be set to divide pulses by a factor of 1 to 9999.

*The pump does not run exceeding the MAN speed at any pulse rate.

*The pump makes one stroke per pulse when the divisor is set to 1.

Example) When the divisor is set to 5, the pump makes one stroke every 5 signals.

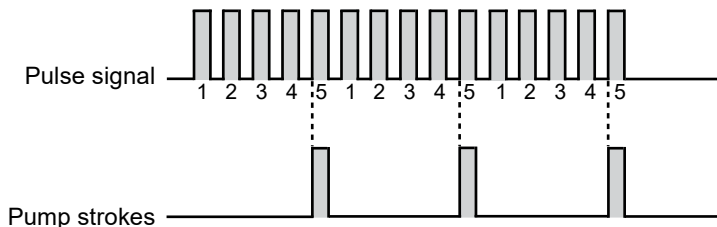

Buffer (Pulse Input Memory): As digital pulses come into the pump, internal memory can be set to store these pulses if they come in too fast for the pump to keep up. Once the incoming pulses slow or stop, the pump will work off the excess pulses. The factory default settings are that the memory is OFF for the divide mode.

*The buffer stores the external signals for up to 65535 strokes.

■ MULTI (multiplier) control

The pump can accept a non-powered (dry contact) pulse signal from a flowmeter or other similar instrument. In multiply mode, 1 input pulse can produce 1 to 9999 pump strokes.

*In the EXT operation, the pump runs at the MAN speed at any pulse rate.

*The pump makes one stroke per pulse when the multiplier is set to 1.

Example) When the multiplier is set to 5, the pump makes five strokes per signal.

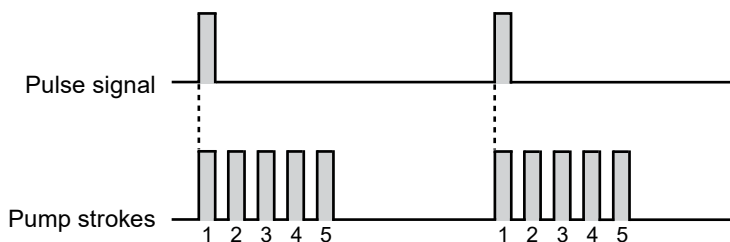

Buffer (Pulse Input Memory): As digital pulses come into the pump, internal memory can be set to store these pulses if they come in too fast for the pump to keep up. Once the incoming pulses slow or stop, the pump will work off the excess pulses. The factory default settings are that the memory is OFF for the multiply mode.

*The buffer stores the external signals for up to 65535 strokes.

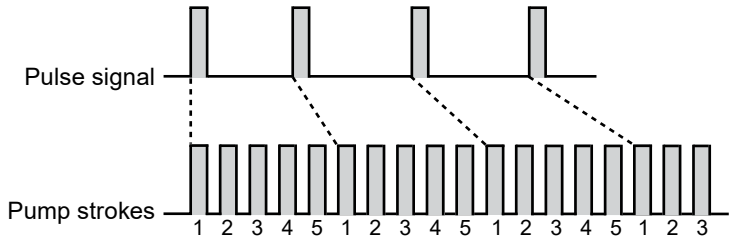

■ BATCH control

In the batch control, the pump runs until the set volume per pulse is completed and stops afterward. The batch volume shown on the pump screen is getting lower as feeding advances.

*The pump runs at the MAN speed.

*The alarm signal that lets you know of the completion of the batch feed can be set to the OUT 1 terminal. See page 94.

When "bF.MEM" is OFF:

Any input of the external pulse signal will be canceled when the pump is activated for the earlier pulse input. The next dosing becomes ready after the preset flow volume has been completed.

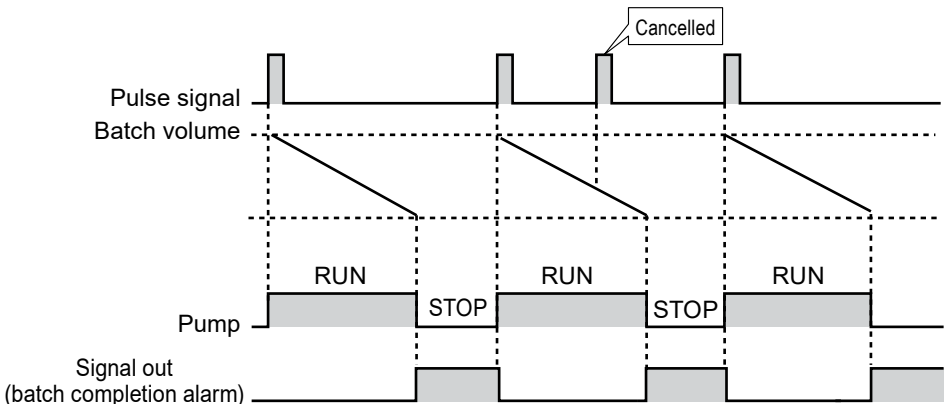

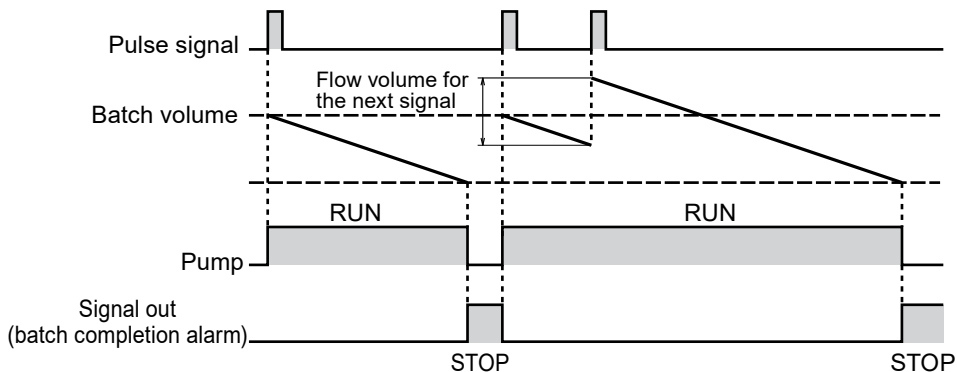

When "bF.MEM" is on:

Every time the external pulse signal is input, the preset flow volume per pulse is added to the earlier volume for the earlier pulse input (added up to 65535 pulses or 99.9999 liter (or 26.4199 gal), whichever reached first).



Pulse input with the Enter key:

Instead of the pulse signal input, pushing the  key can start the batch control.

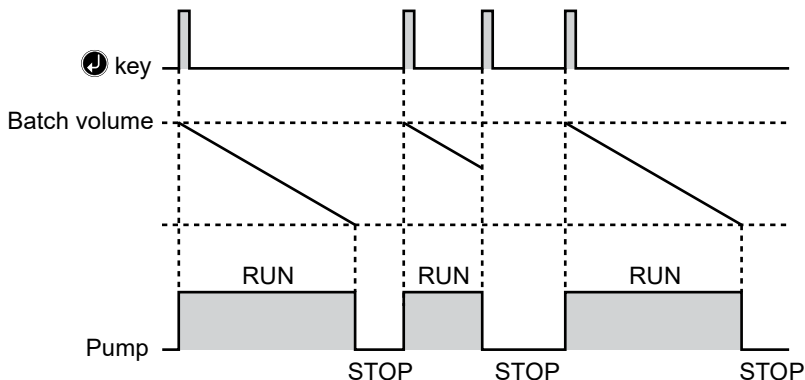

*If the  key is pushed before the batch volume is finished, that volume is canceled and the pump stops. No matter whether the buffer is turned ON or OFF.



■ INT.B (interval batch) control

To make an interval batch control, set a date and time interval and the batch volume. The EWP produces the preset batch volume at a set interval. In the diagram below, the interval is set to 1 hour.

*The pump runs at the MAN speed.

*The control is triggered by either the external pulse signal or the push of the  key. Push the  key to stop the control.

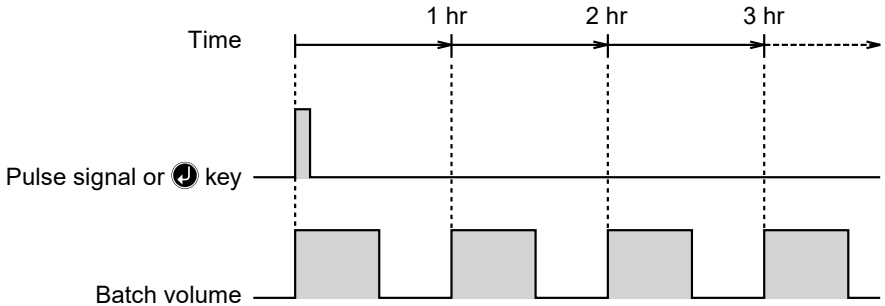

AUX function

The pump runs at the AUX speed while receiving the external signal via the AUX terminal. See page 76. Use this function to prime the pump or to remove entrained air in operation.

*Set the AUX speed in advance.

*This function is enabled during the MAN RUN mode or the EXT RUN mode. Once the AUX signal is stopped, the mode returns to the MAN speed or restarts the programmed EXT mode.

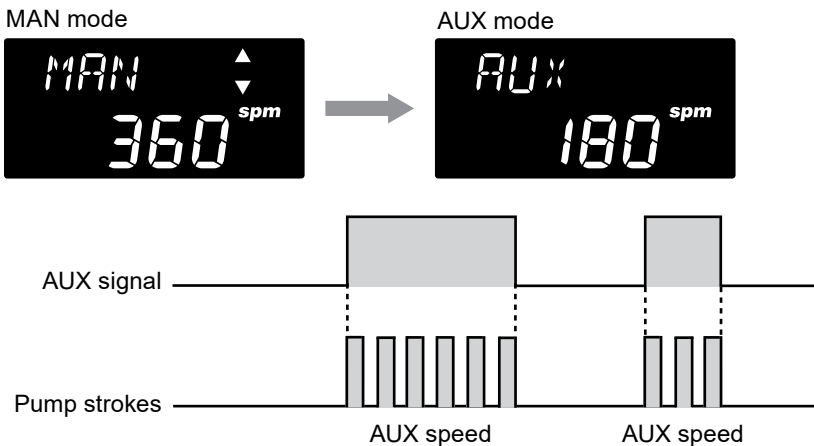

Priming function

The pump runs at the maximum stroke rate while the **ⓘ** key is depressed. Use this function for priming or degassing. The pump returns to the MAN speed after this key is released. See page 76 for detail.

*This function is enabled in the MAN mode or EXT mode.

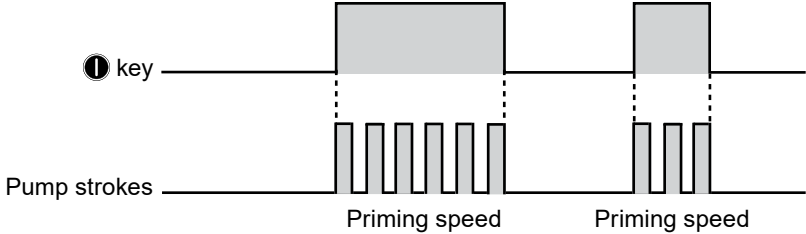

Control functions

■ STOP function

The start/stop of the pump can be controlled by external devices such as a level sensor. The I.LOCK function dominates this function.

*You can relate this input to the alarm output. See page 94 as well.

MAN mode

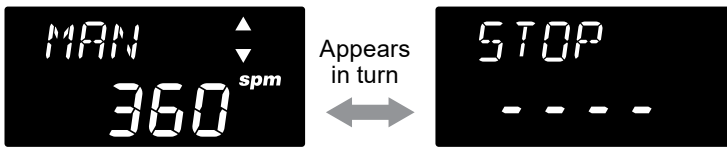

When the "n.o" logic option is selected (page 103):

The pump stops while receiving the external signal via the STOP terminal (normally-open contact). The status LED lights purple.

*Opening the STOP circuit resumes pump operation.

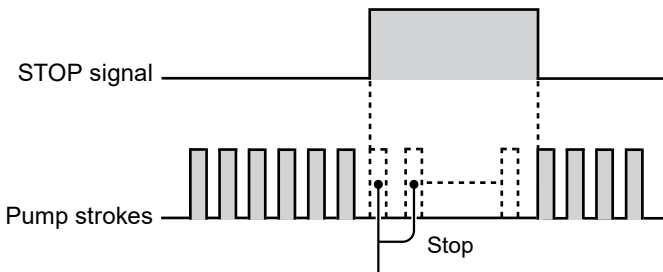

The pump stops running while the STOP signal is inputted.

When the "n.c" logic option is selected (page 103):

The pump stops while NOT receiving the external signal via the STOP terminal (normally-closed contact). The status LED lights purple.

*Closing the STOP circuit resumes pump operation.

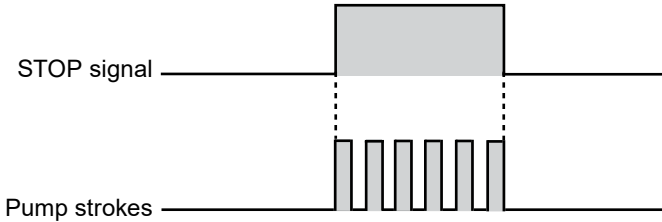

■ Pre-STOP function

The Pre-STOP signal has nothing to do with pausing or resuming the pump operation but reminds you of a low liquid level or empty tank. The status LED blinks orange.

*You can relate this input to the alarm output.

MAN mode



Appears in turn



When the "n.o" option is selected (page 103):

The status LED blinks/lights orange while the pump is receiving the external signal via the Pre-STOP terminal (normally-open contact).

When the "n.c" option is selected (page 103):

The status LED blinks/lights orange while the pump is NOT receiving the external signal via the Pre-STOP terminal (normally-closed contact).

■ Interlock function

The interlock switch can be tied directly into the pumps to stop or start operation. A typical example is emergency stop of the pump as this signal dominates any other external signal. See page 94 as well.

*You can relate this input to the alarm output.

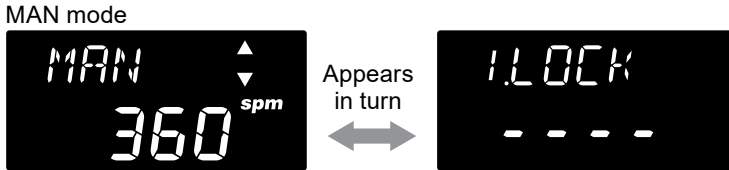

Output functions

The pump has the following outputs with different functions.

■ Pump out

The pump transmits the signals to another pump or your equipment in synchronous with strokes.

■ Alarm out

The pump transmits the signal when:

- the STOP signal is input (e.g. Low-Low alarm output from the level sensor),
- the Pre-STOP signal is input (e.g. Low alarm output from the level sensor),
- the Interlock signal is input, or
- the batch control is finished.

■ State out

The pump transmits the signal while the pump is running. The signal stops at the wait state or when the pump is stopped by the STOP/I.LOCK signal. This signal can be used as an answer-back signal to an operating command.

Other functions

■ Calibration



Calculate the output capacity per stroke by dividing the delivered liquid volume by the number of strokes. Calibration should be made in the actual piping system with the adjusted stroke rate/length, or the accuracy may decrease. See page 68 as well.

■ Keypad lock

This pump is shipped with the access codes of default values (0000). In order to prevent unauthorized tampering, you will need to change the access codes to your own values. See page 76 and 105 for detail.

■ Factory default setting

Power on the pump while depressing the  key and hold it for 3 seconds to get it back to the factory default setting besides the logging data.

Turn on the pump while pressing  key 

Restoring the factory default



■ Anti-chattering factor

Set the bounce threshold based on the actual pulse width (ON time) in order to prevent the adverse effect of chattering (contact bounce) and electrical noise. This pump is designed to receive the external signal of the 50% duty cycle. The factory default threshold is 5 msec (100Hz ON time). With this value, the control unit recognizes the signal of 5 msec or wider ON time (or OFF time). Selecting the smaller 3 msec will allow shorter duration pulses to be recognized (typical for Hall Effect input), while the 20 or 50 msec setting will help to reduce erroneous pulses from noise (as from a reed switch).

Glossary

Chattering

The rapid, repetitive noises made from contact bounce of the mechanical relay or switch. Chattering can cause malfunction to electric devices or parts.

■ Input/Output logic

Select “normally open” or “normally closed” for the INPUT 1, 2, and 3 as well as the signal OUTPUT 1. See page 103 as well.

Installation

This section describes the installation of the pump, tubing and wiring. Read through this section before work.

! Points to be Observed

- Risk of electrical shock. Be sure to turn off power to stop the pump and related devices before service is performed.
- If you notice any abnormal or dangerous conditions, suspend operation immediately and inspect/solve problems.
- Do not place explosive or flammable material near the pump.
- Do not use a damaged pump. Use of a damaged pump could lead to an electric shock or death.
- Do not mount the pump in an area with mechanical vibration. Ensure that the pump base does not experience vibration while it is being transported.
- Do not reuse the old pump base for holding the new pump.

Pump mounting

Select an installation location and mount the pump.

Floor mount

There are two ways to mount the pump on a level floor.

■ Mounting on the detachable pump base

A pre-installed pump base will help easy installation and maintenance. A tubed, wired, and programmed pump can be mounted in place on the pump base, and removed as it is, also.

Necessary tools

- Four M5 cap bolts (purchase separately)
- 4mm hex wrench

1 Select a suitable place

Always select a flat floor free of vibration. See page 16 as well.

*Flooded suction is strongly recommended, especially when pumping liquids that readily generate gas bubbles. Sodium hypochlorite and hydrogen peroxide are common examples of such liquids.

2 Use the four M5 head bolts and fix the pump base

Be sure to fix the pump base at four points.

NOTE

If the pump is not installed level, output may be affected.

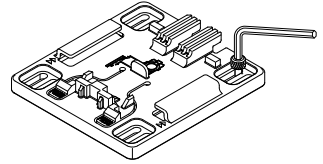

3 Slide the pump onto the pump base

All the way until the pump clicks into the PRESS hooks of the separate pump base.

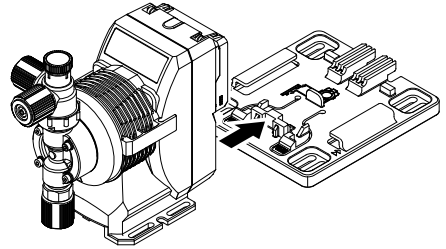

To remove the pump from the pump base, slide forward the pump while depressing the "PRESS" hooks.

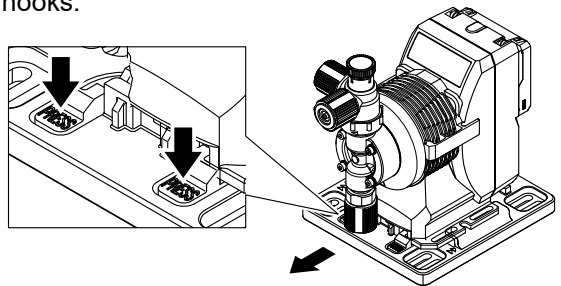

NOTE

Be careful not to catch your finger in the PRESS hooks.

■ **Mounting on the floor (without pump base)**

Necessary tools

- Four M5 bolts (purchase separately)
- Adjustable wrench
- Two baseplates (pumps with SH wet end code)

1 Select a suitable place

Always select a flat floor free of vibration. See page 16 as well.

*Flooded suction is strongly recommended, especially when pumping liquids that readily generate gas bubbles. Sodium hypochlorite and hydrogen peroxide are common examples of such liquids.

2 Place two baseplates on the pump (SH only)

The pump with the SH wet end code is heavier than other models. It is recommended to use the optional metal baseplates (supplied separately) to reinforce the pump's base.

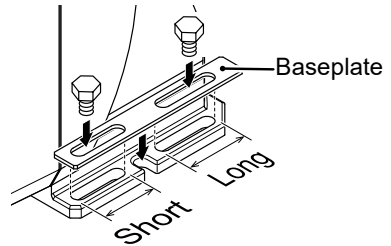

3 Use the four M5 bolts and fix the pump

Be sure to fix the base at four points.

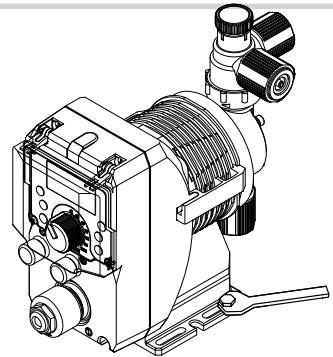

Wall mount

The pump can be mounted on the wall also (except the pump with SH wet end code).

Necessary tools

- Four M5 cap bolts (purchase separately)
- 4mm hex wrench

1 Select a suitable place

The pump should be mounted on a vertical wall that is firm, vibration-free surface, and easily-accessible.

2 Use the M5 anchors to create vertical mounting holes

Use the copy of the mounting hole dimensions on page 130 to locate the mounting hole positions.

3 Use the M5 cap bolts to mount the pump base using the holes

The pump base has a mounting direction. See below.

*Always check that the cap bolts are caught by the upper end of the mounting slots of the pump base.

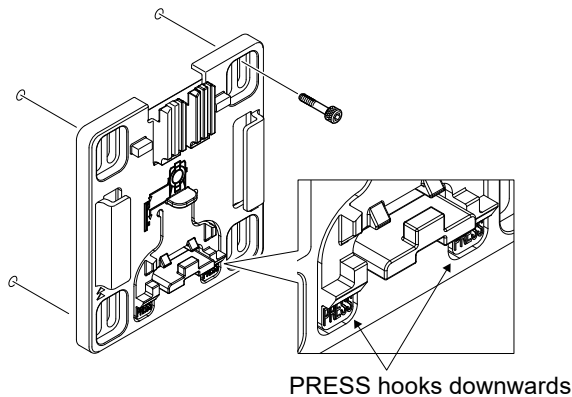

4 Slide the pump into the pump base

All the way until the pump clicks into the PRESS hooks of the pump base.

*The pump can be mounted from both the right side and the left side.

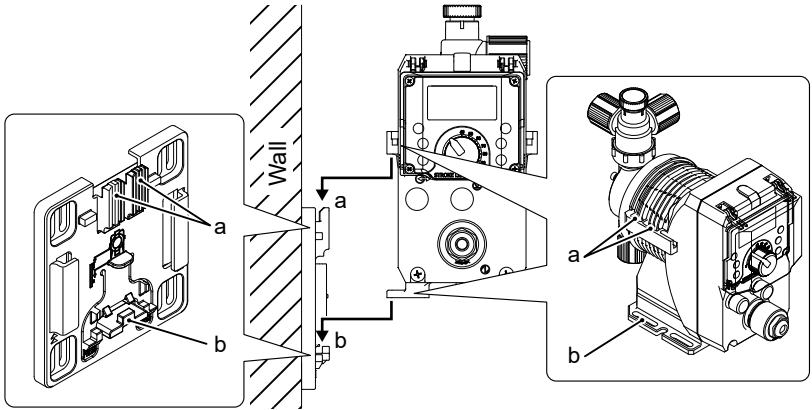

5 Check that:

- The PRESS hooks hold the pump securely.
- The pump stays horizontal.

To remove the pump from the pump base, slide out the pump while depressing the PRESS hooks.

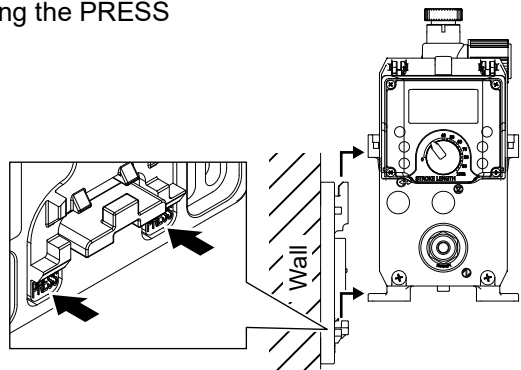

NOTE

Be careful not to drop the pump.

Plumbing

Connect tubes to the pump and install a check valve.

Before operation

- Cut the tube ends flat.

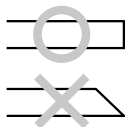

Tube end (side view)

Necessary tools

- An 1.5" (38mm) or wider adjustable wrench

Tube connection

- Pass the tube through the fitting nut and stopper, and then slide it down onto the adaptor as far as it will go.
- Put the tube end (adaptor) onto the fitting. Then hand tighten the fitting nut.
- Retighten the fitting nut by turning it further 180 degrees with an adjustable wrench so it crushes into the tube a little.

*Do not use excessive force when tightening the plastic fitting nut.

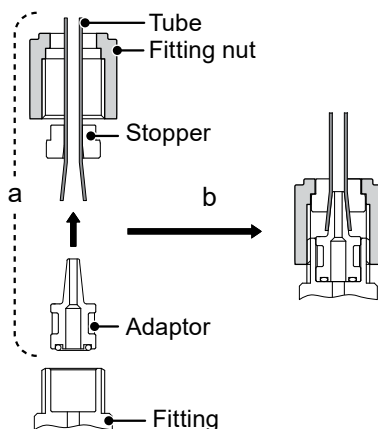

When the tube is removed and then reconnected

- If the fitting nut, stopper, adaptor, fitting, or tube surface is wet with a chemical liquid, flush with tap water and then dry off. Wet parts won't bite into the tube successfully, and the tube may slip out of the connection with a chemical spill.
- When removing the connection, if the adaptor has become stuck in the crushed tube and stopper and those parts can not be separated, contact us for a new adaptor/stopper set.
- Do not reuse the same crushed tube end to reseal the tubing. Cut off the end and start with new tubing to ensure a new seal is established.
- Use a new tube if the old tube is hardened, swollen, discolored, cracked, worn, or sticky.

1 Connect tubes into the pump inlet and outlet

*Use the proper tube size depending on wet end materials and the pump type. See page 27.

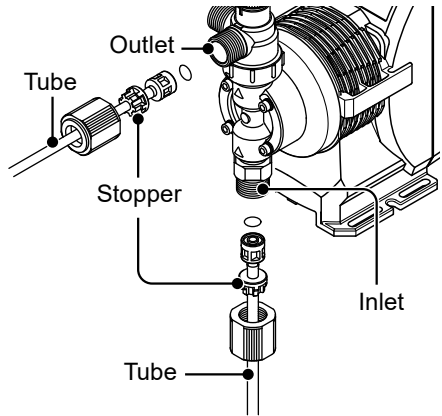

2 Connect a tube to establish the air vent line

Route back the other tube end line to a supply tank or a container.

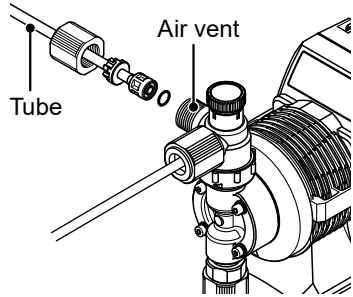

3 Determine the air vent body A direction

- a. Loosen the lock nut.
- b. Turn the air vent body A to the optimal direction.
- c. Hand-tighten the lock nut, holding the air vent body A.
- d. Use an adjustable wrench to turn the lock nut 90° further from the hand-tightened point.

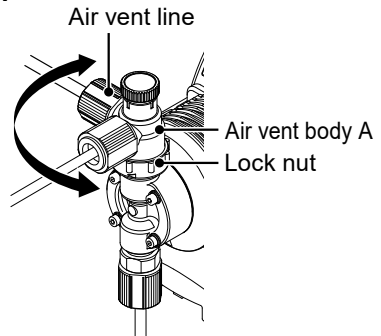

Thread connection

- 1** Wrap a sealing tape around the threads of the discharge/ suction pipe and tighten them

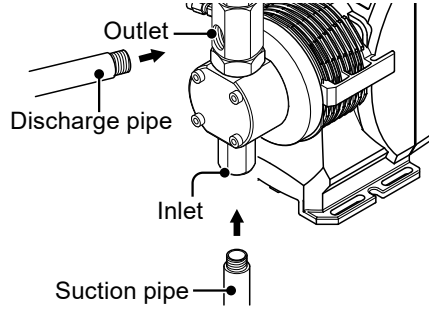

- 2** Establish the air vent line

- Loosen the nut. Pass the air vent tube through the nut.
- Slide the air vent tube down into the male thread connector as far as it will go.
- Hand-tighten the nut.
- Use an adjustable wrench to turn the nut 45° further from the hand-tightened point.
- Route back the other tube end to a supply tank or a container.

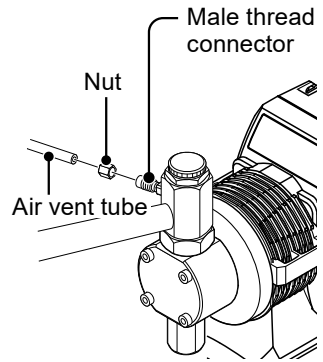

Tubing layout

Flooded suction application

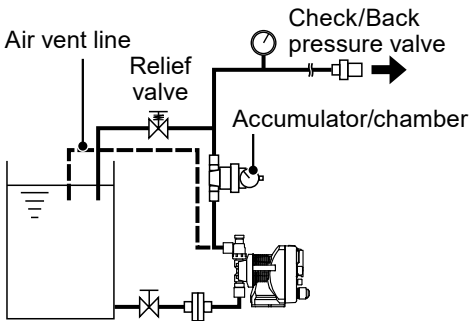

Suction lift application

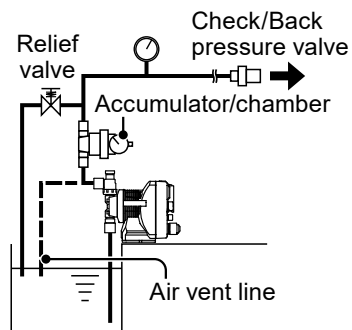

*Flooded suction is strongly recommended, especially when pumping liquids that readily generate gas bubbles. Sodium hypochlorite and hydrogen peroxide are common examples of such liquids.

NOTE

The air vent port is not provided to the EWP with FC wet ends. Purchase separately and install an external air vent valve to your piping as the right diagram shows.

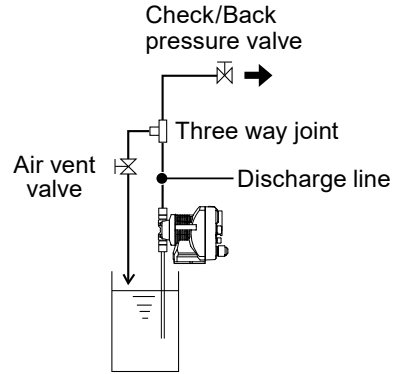

Check valve/Back pressure valve mounting

Install an optional check valve or a back pressure valve to the pump for the prevention of a back flow, siphon and overfeeding. In the following cases be sure to install the check valve.

- A suction side liquid level is higher than the discharge side.

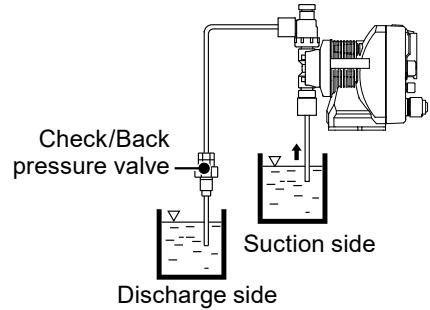

- A suction side liquid level is lower than the discharge side but the height distance is 16.4ft (5m) or below.

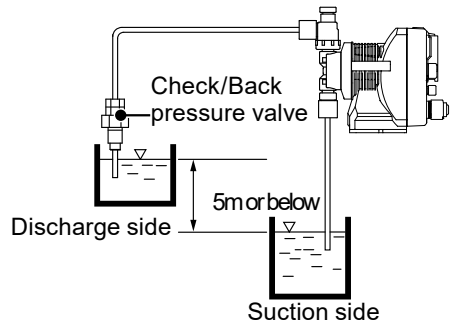

- A suction line pressure is higher than a discharge line pressure.

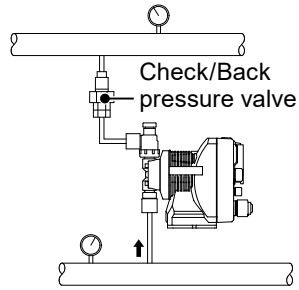

- The back pressure to the pump (including pipe resistance and discharge head) is below 18.9PSI or 0.13MPa. (below 7.1PSI or 0.049MPa for the EWP-410F/-420F).

1

Mount an optional check valve at the discharge tube end

*The CAN check valve has the R $\frac{1}{2}$ and R $\frac{3}{8}$ thread connections as well as an O.D.9mm tube connection. If required, trim off an amount of the extension tip until it fits your fitting or tee.

NOTE

The maximum allowable tightening torque of the R $\frac{1}{2}$ and R $\frac{3}{8}$ thread connections are 88.51 lb-in (10 N·m). Do not use excessive force when tightening into a pipe.

CAN check valve

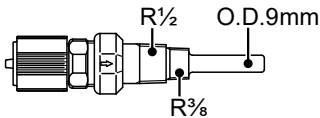

*The CBN check valve (both ends tube connections) and the BVC back pressure valve are optionally available. Contact us or your nearest distributor.

CBN check valve



BVC back pressure valve

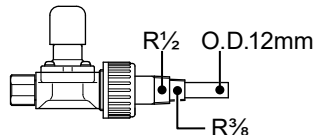

NOTE

- Install a relief valve on a discharge line near the pump so as to automatically release the discharge pressure when it exceeds the maximum level.
- If the set pressure of the check valve plus the injection point pressure to your system is lower than the maximum discharge pressure of the pump, the pump output can exceed the specified point. See page 64 and adjust the output capacity.

Wiring for a power voltage, earthing and an external signal.

! Points to be observed

- Electrical work should be performed by a qualified electrician. Always observe applicable codes or regulations.
- Observe the rated voltage range, or the electrical circuit in the control unit may fail.
- Risk of electrical shock. Be sure to turn off power to stop the pump and related devices before service is performed.
- Risk of electric shock. Replacement of the power cable should be conducted by a manufacturer, his agency or a skilled person.

End terminals

See the following diagram for detail.

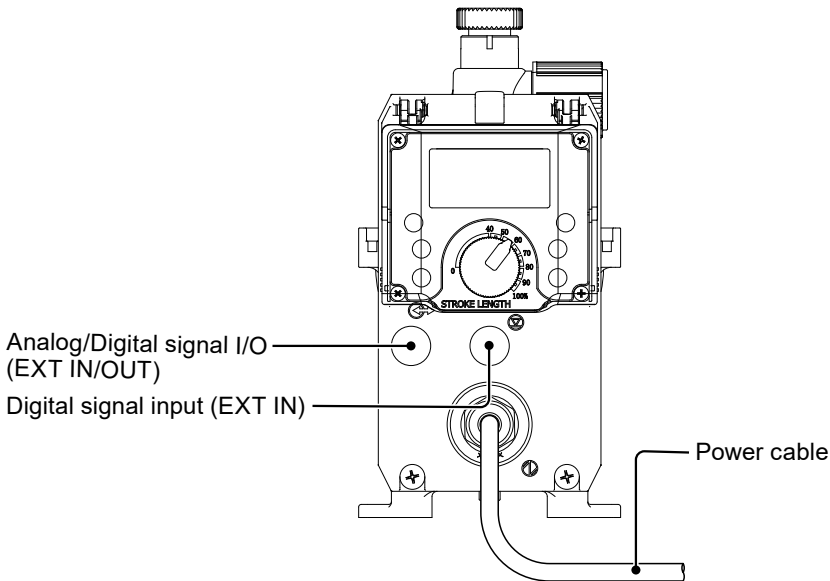

Power voltage/Earthing

Check that the main power is turned off.

■ Pump with the "US" or "UH" power plug codes

1 Insert the plug all the way seated in a socket

This product has two power wires and one earth wire, and is classified as class I.

*This pump is supplied with a grounding-type attachment plug. To reduce the risk of electrical shock, be certain that it is connected only to a properly grounded, grounding type receptacle.

NOTE

- Do not share a power source with a high power device which may generate surge voltage. Otherwise an electronic circuit may fail. The conductive noise caused by an inverter also affects the circuit.
- Energize the pump with a power voltage via a mechanical relay or switch. Do not fluctuate the voltage, or CPU may malfunction. See page 52 for the precautions for ON-OFF control by cycling power.

Apply power sharply

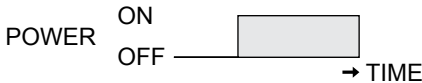

Do not apply gradually

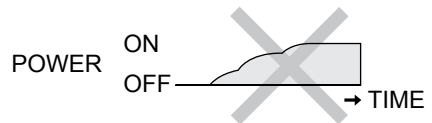

- Use a circuit protector (250VAC, 3A Medium speed) as necessary.
- Do not use a motor thermal relay.

Surge voltage

The electronics within the pump can be damaged by excessive surges in voltage. Do not install the pump near high-power electrical equipment that generates high surge voltages. Avoid branch circuits that also supply power to heavy or other equipment that could generate electrical interference.

If necessary,

- install a surge suppression device (such as a varistor with a resistance greater than 2000A)

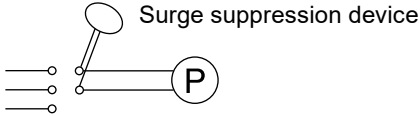

Recommended varistors

Panasonic ERZV14D431

KOA NVD14UCD430

See manufacturer's catalogs for detail.

- or a noise-reducing transformer at the pump's power connection.

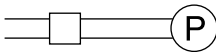

Noise-reducing transformer

Precautions for ON-OFF control by cycling power

The control unit is equipped with a CPU. To ensure the CPU to work properly, always start/stop the pump with the STOP signal for ON-OFF control. Try not to turn on and off the main power. Otherwise, observe the following points:

- Ensure the minimum OFF time of 10 minutes.
- When using a mechanical relay for ON-OFF operation, its contact capacity should be 5A or more. Or a contact point may break.
- If a mechanical relay with the contact capacity of 5A is used, the maximum allowable number of power cycles is limited to 150,000 times. Use the contact capacity of 10A or more when the power cycles exceed that number or when a power source is shared with a large capacity equipment which may cause a surge voltage and damage a contact point.
- Even the large mechanical relay may not last forever. If further longer life is desirable, use a SSR (Solid State Relay) such as the OMRON G3F that does not have a mechanical contact point. Note this product is not designed to be operated with a zero-crossing SSR. See manufacturer's catalogs and make sure a non zero-crossing SSR is selected.

Signal wire connection

Points to be checked

- Check that the main power is turned off.

Applicable cables

Use our optional connector cables below or purchase DIN 4- and 5-pin female connector cables when using signal input and output.

Optional DIN connector cables for:

- The EXT IN/OUT signal (or Binder 99-0436-10-05 Series 713)
- The EXT IN signal (or Binder 99-0430-15-04 Series 715)

NOTE

- Do not install these signal cables in parallel with a power cable. Otherwise the electromagnetic induction noise is generated and malfunction or failure may result.
- When using an external SSR for signal input, such a semiconductor relay must be capable of handling the maximum applied voltage from the pump (5V with 2.3mA). Also, its leak current must be 0.1mA or below.
See specs of the selected SSR. The following SSRs at least meet the requirements:
- OMRON G3TA-IDZR02S-US or G3TA-IDZR02SM-US
- When using an external mechanical relay for signal input, such a relay must be capable of handling the maximum applied voltage from the pump (5V with 2.3mA). Its minimum application load should be 1mA or less.
- Insert the DIN 4- or 5-pin female connector as far as it will go and then tighten the locking collar to make a secure connection.
- Connect the signal cables to external devices which are protected by double or reinforced insulation.

*Use either an external no-voltage contact or an external open collector for the signal line wiring.

■ EXT IN/OUT

Wiring diagram

To make the EXT operation, to activate the STOP/P.STOP/I.LOCK/AUX functions, or to output the SPM/ALARM/STATE signal, use the EXT IN/OUT terminal via a DIN 5-pin connector.

- **When using an analog signal from the 4-20 mA signal generator:**

Polarity Sensitive. Connect the 4-20mA line to the ANA IN (positive) and COM. The input resistance is 220Ω.

- **When using an open collector signal from an external device to the pump:**

An open collector signal is polarity sensitive. Use the DIG 1 IN (POSITIVE) and the COM (GND).

- **When using a dry contact signal from an external device to the pump:**

A dry contact signal is generally not polarity sensitive. Use the DIG 1 IN and the COM. Use a mechanical relay or switch designed for an electronic circuit. Its minimum application load should be 1mA or less.

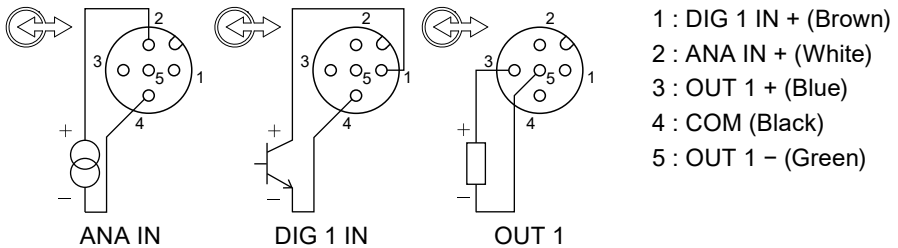

*The OUT 1 is an open collector output (polarity sensitive) capable of handling the maximum applied voltage of 24 VDC at up to 10 mA from an external device.

Pin assignment

You can set an EXT control or a function corresponding to input/output wirings.

Input	Terminals		EXT controls/functions	Parameters	
	+	-		EXT code	Input/Output
ANA IN	PIN 2 (White)	PIN 4 (Black)	Analog preset control	ANA.P	—
			Analog variable control	ANA.V	—
DIG 1 IN	PIN 1 (Brown)	PIN 4 (Black)	Pulse variable control	PLS.V*	PULSE
			Pulse divisor control	DIV*	
			Pulse multiplier control	MULTI*	
			Batch control	BATCH*	
			Interval batch control	INT.B*	
			STOP function	—	STOP
			PreSTOP function	—	P.STOP
OUT 1	PIN 3 (Blue)	PIN 5 (Green)	spm synchronous output	—	SPM
			Alarm output	—	ALARM
			Pump state output	—	STATE
			AUX function	—	AUX
			Interlock function	—	I.LOCK

*If the PLS.V, DIV, MULTI, BATCH, or INT.B control mode is selected over the EXT type, the DIG1.1 input is automatically set to the PULSE option. No matter what input option is being set.

■ EXT IN

Wiring diagram

To activate the STOP/P.STOP/I.LOCK/AUX functions, select the EXT IN terminal via a DIN 5-pin connector.

• **When using an open collector signal from an external device to the pump:**

An open collector signal is polarity sensitive. Use the DIG 2 (or 3) IN (POSITIVE) and the COM (GND).

• **When using a dry contact signal from an external device to the pump:**

A dry contact is generally not polarity sensitive. Use the DIG 2 (or 3) IN and the COM. Use a mechanical relay or switch designed for an electronic circuit. Its minimum application load should be 1mA or less.

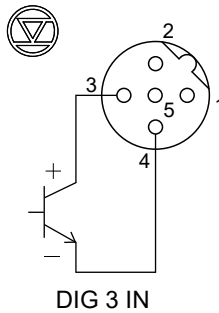
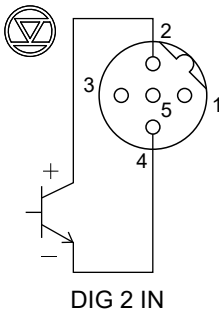

- 1 : 12 VDC + (Brown)
- 2 : DIG 2 IN + (White)
- 3 : DIG 3 IN + (Blue)
- 4 : COM (Black)
- 5 : COM (Green)

*Sensor Power: The control circuit of the EWP series has the ability to provide 12 VDC at up to 2.3 mA to power a Hall effect sensor or similar device. Connect the sensor power leads to terminal 1 (positive) and terminal 4 or 5 (negative) of the terminal.

Pin assignment

You can set an EXT control or a function corresponding to input wirings. Select the DIG 2 or DIG 3 in the input selection menu.

Input	Terminals		EXT functions	Parameters	
	+	-		EXT code	Input
DIG 2 IN or DIG 3 IN	PIN 2 (White)	PIN 4 (Black)	STOP function	–	STOP
		or PIN 3 (Blue)	PreSTOP function	–	P.STOP
	or PIN 3 (Blue)	or PIN 5 (Green)	AUX function	–	AUX
				Interlock function	–

*Always use the PIN 2 and PIN 4 when using the DIG 2 IN, and PIN 3 and 5 when using DIG 3 IN.

Operation

***This section describes pump operation and programming.
Run the pump after pipework and wiring are completed.***

Before operation

First check tubing and wiring are correct. And then perform degassing and flow rate adjustment before starting operation.

Points to be checked

Before operation, check if:

- Liquid level in a supply tank is enough.
- Tubing is securely connected and is free from leakage and clogging.
- Discharge/suction valves are opened.
- A power voltage is in the allowable range.
- Electrical wiring is correct and is free from the risk of short circuit and electrical leakage.

Retightening of head bolts

Important

Head bolts may loosen when plastic parts creep due to temperature change in storage or in transit. This could lead to a chemical leak. Tighten the screws diagonally and evenly by the rated torque at each model before initial operation and at regular intervals (every three months).

Tightening torque

Model code	Torque	Bolts
EWP-038B/-080C/-130D/-270E	19.12 lb-in (2.16 N•m)	M4 hex. socket head bolt
EWP-410F/-420F	22.57 lb-in (2.55 N•m)	M5 hex. socket head bolt

■ Use of hex wrench instead of a torque wrench

- 1** Fasten the four head bolts as tight as can be with the straight long part of a hexagon wrench

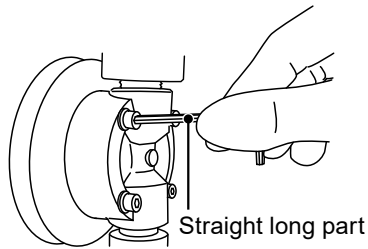

- 2** Further turn the head bolts clockwise 90° with the short part

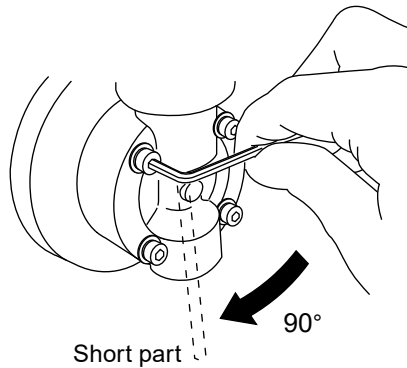

Degassing

The gas in the pump and tubing is the obstacle to liquid delivery and needs to be expelled before the pump is started. Especially:

- When the pump starts to run for the first time
- When a flow rate is too low
- After liquid is replaced in a supply tank
- After a long period of stoppage
- After maintenance and inspection are performed

NOTE

- Both gas and chemical come out together through an air bleed tube. Make sure the end of the tube is located in a supply tank or a container.
 - Some chemicals are harmful or attack non-wetted parts. Wash/wipe chemicals off immediately if getting wet.
-

■ EWP VC/VS/VE/PC/PS/PE/TC/SH with the MAN air vent port

Points to be checked

- An air bleed tube is connected to the pump.

Air bleed tube

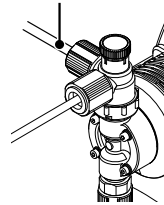

1 Turn on power

The status LED lights up, the display momentarily shows the software version, and the controller goes to whatever mode the pump was in when power was disconnected.

*If being powered for the first time, the pump is in the MAN/EXT selection mode.

MAN/EXT selection mode



2

Run the pump at the maximum stroke rate

Choose one from the following three methods.

Method 1: Set/Run the full MAN speed. See page 66 and 73 as well.

*If the pump boots up in the EXT mode, use the  key to get back to the MAN/EXT selection mode and choose the MAN mode.

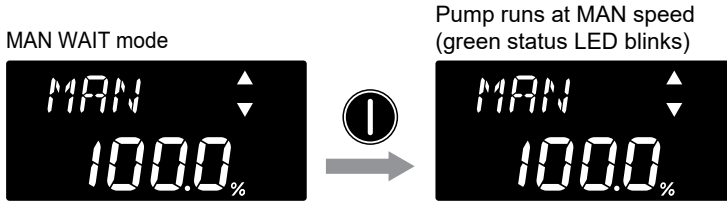

Method 2: Enter the external signal via the AUX terminal. See page 76.

*The pump runs at the AUX speed that is user settable. See page 100.

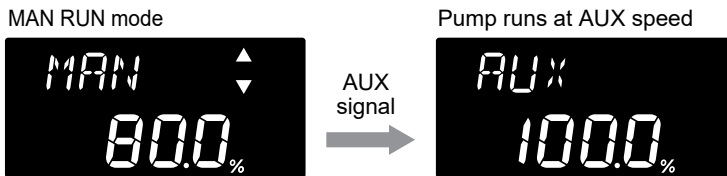

Method 3: Press and hold the  key for more than 3 second. See page 76 for the Priming function section.

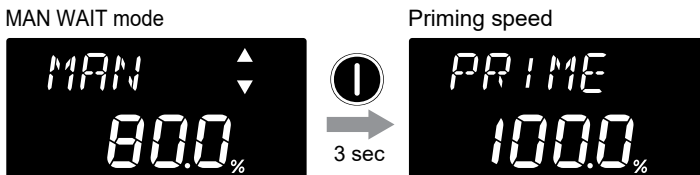

3 Rotate the adjusting screw two revolutions counterclockwise to open the air vent port

*Do not rotate it three revolutions. Otherwise, the adjusting screw may come off with solution spray.

Adjusting screw

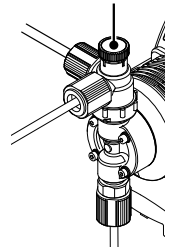

4 Keep the pump running for more than ten minutes for degassing

5 Stop the pump by:

- pushing the **ⓘ** key once (if it's 100% MAN run mode),
- stopping the AUX signal (if it's AUX mode), or
- releasing the **ⓘ** key (if it's priming mode).

6 Rotate the adjusting screw clockwise to close the air vent port

7 Check liquid is delivered to the discharge line

Degassing must be repeated until liquid is outputted from the pump outlet.

8 Check connections for leakage

Degassing has now been completed.

■ EWP FC with no MAN air vent port

No air vent port is provided to the pump with the FC wet end code. Branch the main flow line (discharge side) to establish an open-ended air vent line.

1 Establish an air vent line to your system

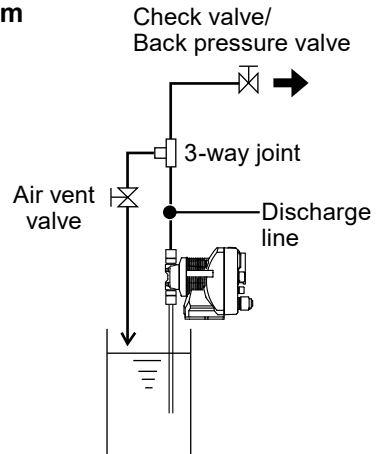

2 Turn on power

The status LED lights up, the display momentarily shows the software version, and the controller goes to whatever mode the pump was in when power was disconnected.

*If being powered for the first time, the pump is in the MAN/EXT selection mode.

MAN/EXT selection mode



3 Open the air vent valve and run the pump at the maximum stroke rate

Choose one from the following three methods.

Method 1: Set/Run the MAN speed 100%. See page 66 and 73 as well.

*If the pump boots up in the EXT mode, use the  key to get back to the MAN/EXT selection mode and choose the MAN mode.

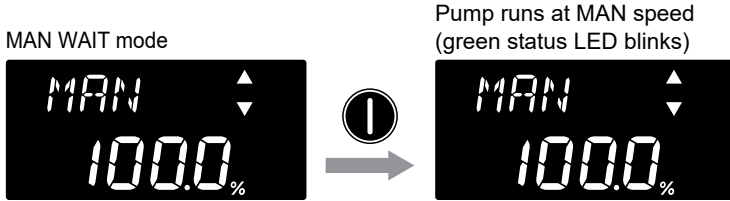

Method 2: Enter the external signal via the AUX terminal. See page 76.

*The pump runs at the AUX max speed. See page 100 as well.

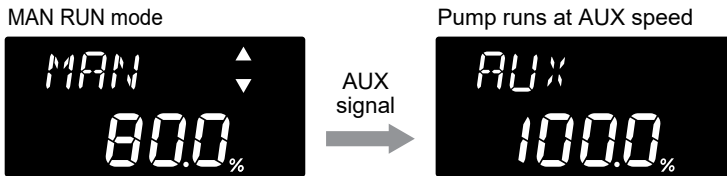

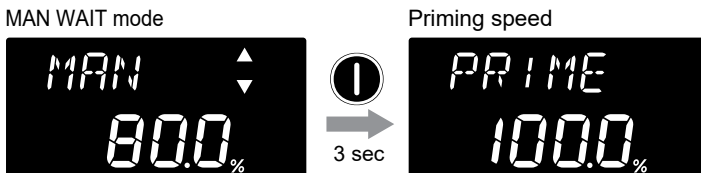

Method 3: Press and hold the  key for more than 3 seconds. See page 76 for the Priming function section.



4 Keep the pump running for more than ten minutes for degassing

5 Stop the pump by:

- pushing the  key once (if it's 100% MAN run mode),
- stopping the AUX signal (if it's AUX mode), or
- releasing the  key (if it's priming mode).

6 Close the air vent valve

7 Check liquid is delivered to the discharge line

Degassing must be repeated until liquid is outputted from the pump outlet.

8 Check connections for leakage

Degassing has now been completed.

Flow rate adjustment

The flow rate can be adjusted by modulating a stroke rate and stroke length. The stroke rate represents the pump speed in %. The stroke rate adjustment is the main way to adjust the flow rate from the pump.

The stroke length represents the moving distance of the shaft. The widest moving distance is defined as 100% stroke length. The stroke length adjustment is used for determining the optimal volume pumped per stroke (fine adjustment of the pump flow).

First adjust the flow rate with the stroke rate adjustment. Use stroke length adjustment for the range where the stroke rate adjustment can not reach. Note the optimal stroke length changes with operating conditions and liquid characteristics.

The following procedure is recommended.

1 With the stroke length 100%, adjust the stroke rate to meet the desired output

See the "Stroke rate adjustment" section (page 66) and the "Stroke length adjustment" section (page 67) for detail.

2 Measure the pump output

3 If the measured output is lower/higher than the desired level, increase/decrease strokes and measure the pump output again

4 Adjust the stroke length for fine adjustment

5 Measure the output again to see if the desired output is obtained

Flow rate, stroke rate and stroke length

EWP-038

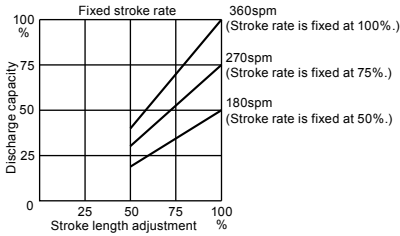

EWP-080/-130/-270/-410/-420

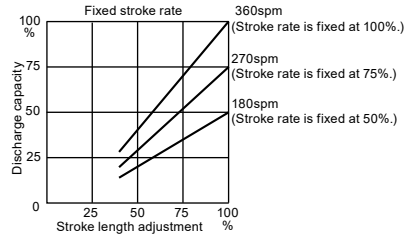

NOTE

- When back pressure is high, set the stroke length to 100% and adjust the pump flow by modulating the stroke rate.
- When each dose greatly affects a chemical reaction in neutralization or titration application, shorten the stroke length to reduce the volume pumped per stroke. And then tune the stroke rate to finalize.
- When handling liquids that readily generate gas bubbles (sodium hypochlorite or hydrazine solution), set the stroke length to 100% and adjust the pump flow by modulating the stroke rate. Note air lock may occur when the stroke length is set too short.

■ Stroke rate adjustment

The stroke rate can be set by keypad operation from 0.1 to 100.0%.

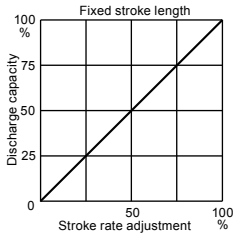

*The nameplate shows the maximum (100%) output with the full stroke rate and length.





1 Turn on power and select the MAN mode

Use the  key to select the % unit.

*If the pump is turned on with the EXT mode, use the  key to return to the MAN/EXT selection mode.

*When either the "STOP", "P.STOP", or "I.LOCK" display appears on the screen, see page 93 and deactivate that input signal.

2 Use the or key to adjust the stroke rate

The stroke rate can be changed by pressing the  and  keys in either the MAN WAIT mode or MAN RUN mode. Press the  to increase the stroke rate and the  key to decrease the rate. Holding the keys down briefly will change the rate slowly, but holding them down for 5 seconds will change the rate rapidly.

3 Push the key to run the pump at the stroke rate

The status LED blinks at each stroke during operation.

■ Stroke length adjustment

The stroke length can be adjusted when the moving distance of the shaft is changed with the stroke length adjusting knob.

Model	Allowable range
EWP-038	50-100%
EWP-080/-130/-270/-410/-420	40-100%

EWP-038

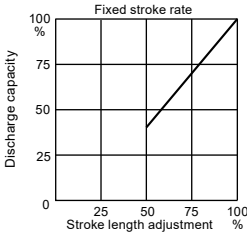

EWP-080/-130/-270/-410/-420

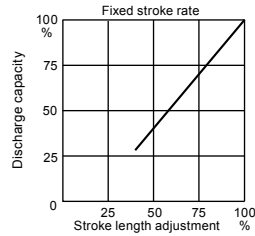

NOTE

- Do not rotate the stroke length adjusting knob when the pump is not running.
- Do not set the stroke length out of the allowable range where the output capacity is not assured.

1 Turn on power and push the key to run the pump

The status LED blinks during operation.

MAN WAIT mode



Pump runs at MAN speed
(green status LED blinks)



2 Rotate the stroke length knob to determine liquid volume per stroke

Stroke length knob

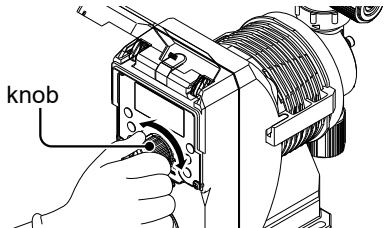

Perform a calibration

Calibrate the pump in your plumbing system with an actual chemical liquid after the flow rate adjustment is done, so that the pump can be operated using a theoretical output capacity. Use a reliable flow meter to measure the flow volume. The pump divides the measured flow volume by strokes to determine the flow volume per stroke. See page 92 for the calibration menu flow.

1 Push the key

MAN/EXT selection mode



Menu mode



2 Push the key once to select the CALIB option



3 Push the key once to confirm the selection

A countdown time shows up.





4 Push the key once again to run the pump

Measure the output capacity from the pump with an reliable flow meter
The pump stops when the countdown is finished .

Countdown time



5 Enter the measured output capacity

Use the  key to move between digits, the  and  keys to change and the  key to confirm the value.

*The  key get back to the CALIB option menu if you don't want to save the new value.

Enter the new value



Before a long period of stoppage (one month or more)

Clean wet ends and the inside of tubing:

- Run the pump with clean water for about 30 minutes to rinse chemicals off from the pump head and piping.

Before unplugging the pump:

- Always stop the pump by key operation and wait for three seconds before unplugging the pump. Otherwise, the last key operation may not be put in memory. In this case the pump unintentionally starts to run as powered on, discharging liquid.

When the pump does not transfer liquid:

- Clean the valve sets and remove foreign matters.
- If gas is in the pump head, expel gas and readjust the output capacity. See the "Degassing" section on page 58 and the "Flow rate adjustment" section on page 64 for detail.

Operation programming

Operation at each mode is individually set and controlled by keypad operation.
Select a proper mode to make optimal operation.

Default setting and Setting range

Control mode	Parameters		Default settings	Setting ranges	STEP
Operation	—		MAN	MAN/EXT	—
	Unit		%	%, spm, mL/m, L/h, GPH	—
MAN RUN/WAIT	Number of strokes	%	100.0	0.1-100.0%	0.1*2
		spm	360	1-360spm	1*2
	Theoretical capacity*5	mL/m	38.01*1	0.01-MAX mL/m*4	0.01*2
		L/h	2.280*1	0.001-MAX L/h*4	0.001*2
GPH	0.6004*1	0.001-MAX GPH*4	0.001*2		
EXT (EXTYP)	Analog rigid (ANA.P)		4-20	4-20, 0-20, 20-4, 20-0	—
	Analog variable (ANA.V)	SP1 (1.mA)	4.0	0.0-20.0mA	0.1*2
		SP1 (1.FL)	0.0%	0.0-100.0%*4, 5	0.1*2
		SP2 (2.mA)	20.0	0.0-20.0mA	0.1*2
		SP2 (2.FL)	100.0%	0.0-100.0%*4, 5	0.1*2
		Patterns (CURVE)	LINE	LINE, BOX, LIMIT	—
	Pulse variable (PLS.V)	Max range (RANGE)	100	100/500Hz	—
		SP1 (1.Hz)	0Hz	0-100 or 0-500Hz	1*2
		SP1 (1.FL)	0.0%	0.0-100.0%*4, 5	0.1*2
		SP 2 (2.Hz)	100Hz	0-100 or 0-500Hz	1*2
		SP2 (2.FL)	100.0%	0.0-100.0%*4, 5	0.1*2
	Patterns (CURVE)	LINE	LINE,BOX,LIMIT	—	
	Divisor (DIV)		1	1-9999	1*2
	Multiplier (MULTI)		1	1-9999	1*2
	Batch control (BATCH)	Capacity (BATCH)	100.0mL 0.0263gal	0.1mL-99.9999L or 0.0001-26.4199 gal	—
	Interval batch control (INT.B)	Day (DAY)	0	0-9	1*3
		Hour (HOUR)	0	0-23	1*3
		Minute (MIN)	1	0-59	1*2
		Capacity (FLOW)	100.0mL 0.0263gal	0.1mL-99.9999L or 0.0001-26.4199 gal	—

Control mode	Parameters		Default settings	Setting ranges	STEP	
Input (INPUT)	Digital input 1 (DIGI.1)		PULSE	PULSE, STOP, P.STOP, I.LOCK, AUX, OFF	—	
	Digital input 1 (DIGI.2)		OFF	STOP, P.STOP, I.LOCK, AUX, OFF	—	
	Digital input 1 (DIGI.3)		OFF	STOP, P.STOP, I.LOCK, AUX, OFF	—	
Output 1 (OUT1)	Trigger (TRIG)		ALARM	OFF, SPM, ALARM, STATE	—	
	Alarm (AL. SET)	STOP signal (STOP)	on	on, oFF	—	
		PreSTOP signal (P.STOP)	oFF	on, oFF	—	
		INTERLOCK setting (I.LOCK)	oFF	on, oFF	—	
		Batch complete (B.COMP)	oFF	on, oFF	—	
Logging (LOG)	Total capacity (T.VOL)		0	—	—	
	Total strokes (SHOT.C)		0×(1K)	—	—	
	OUT1 ON times (OUT1.C)		0	—	—	
	Total power-on time (PW.ON.T)		0	—	—	
	Total operation time (OPER.T)		0	—	—	
Others (OTHER)	Max pump speed (RATE)	Upper limit (MAX)	100.0%	0.3-100.0%	0.1* ²	
		Auxiliary rate(AUX)	100.0%	0.3-100.0%	0.1* ²	
	Buffer memory (bF.MEM)		oFF	on, oFF	—	
	Anti-chattering (ANTI.C)		5	3,5,20,50	—	
	Logic (LOG-IC)	Digital input 1 (DIGI.1)		n.o	n.o, n.c	—
		Digital input 2 (DIGI.2)		n.o	n.o, n.c	—
		Digital input 3 (DIGI.3)		n.o	n.o, n.c	—
		Digital output 1 (OUT 1)		CL	CL, oP	—
	Flow unit (UNIT)	mL/m		on	on, oFF	—
		L/h		on	on, oFF	—
		GPH		on	on, oFF	—
	PIN number to unlock keypads (CODE)			0000	0000-9999	1* ³
Backlight LED ON time (b.LCD)			on	on/1-10	1* ³	

*1 The output capacity is of the EWP-038B and this value changes with pump model.

*2 The parameter increases/decreases step by step every time the up or down key is pushed. Press and hold either key 5 seconds for quick change.

*3 The parameter increases/decreases step by step every time the up or down key is pushed. The quick change does not happen.

*4 The upper limit of programmable values is defined by the calibration results.

*5 The settings can also be done by the spm, L/h, mL/m or GPH.

*6 The value of the lowest place after the decimal point may change due to arithmetic processing.

Programming flow

First set up the menu mode parameters so the pump runs as you desire. Select the MAN or EXT mode and run the pump as programmed.

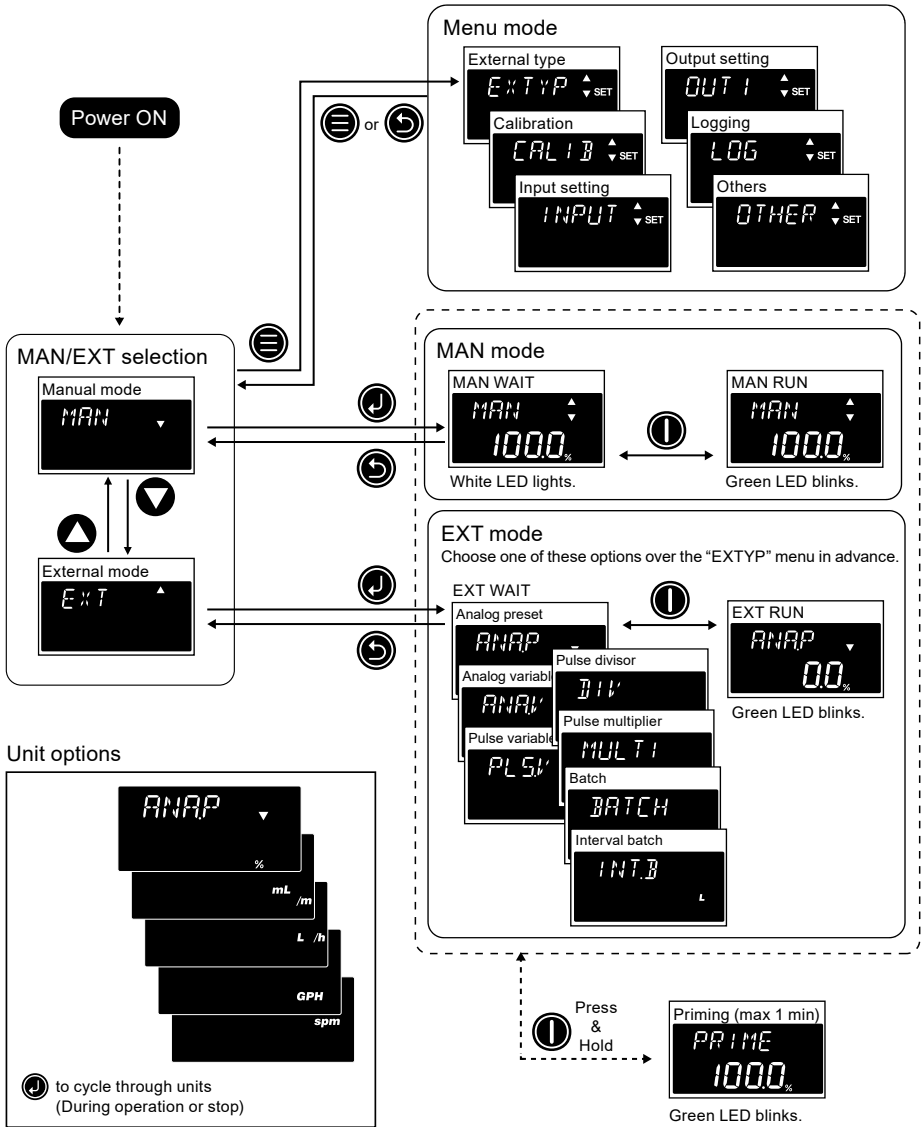

Manual operation

Run or stop the pump with keypad operation.

1 Turn on power

The status LED lights up, the display momentarily shows the software version, and the controller goes to whatever mode the pump was in when power was disconnected.

*If being powered for the first time, the pump is in the MAN/EXT selection mode.

The mode currently selected



2 Push the ⏪ key to enter the MAN/EXT selection mode

If the pump is running in the MAN/EXT RUN mode, push the ⏪ key to stop the pump in the MAN/EXT selection mode in advance.

The mode currently selected



MAN/EXT selection mode



3 Push the ⬆ key to select the MAN mode and then the ⏩ key

In th MAN mode, you can adjust the output capacity with the ⬆ and ⬇ keys during operation or stop.

MAN/EXT selection mode



MAN selected



MAN mode (MAN WAIT)



⏩ key to change units.

4 Push the key

The green LED blinks with every stroke during operation.

*With the  key, you can cycle through the flow unit during operation or stop.

EXT operation

The pump operation is controlled by the external signal. First, see page 54 to hardwire the EXT IN/OUT or EXT IN terminals with your device (e.g. an analog signal generator or a pulse signal generator). And then select the ANA.P, ANA.V, PLS.V, DIV, MULTI, BATCH, or INT.B option over the "EXTYP" menu (page 80). Also see page 28 for how the pump should run corresponding to the external signal.

■ EXT control mode

Set the upper limit spm (MAN speed) and enter EXT mode (except ANA.P/ ANA.V/PLS.V). Note that the pump may start to run as entering EXT RUN mode corresponding to the external signal.

1 Turn on power



The status LED lights up, the display momentarily shows the software version, and the controller goes to whatever mode the pump was in when power was disconnected.

*If being powered for the first time, the pump is in the MAN/EXT selection mode.

The mode currently selected



2 Push the key to enter the MAN/EXT selection mode

If the pump is running in an EXT RUN mode, push the  key to stop the pump and  to move back to the MAN/EXT selection mode.

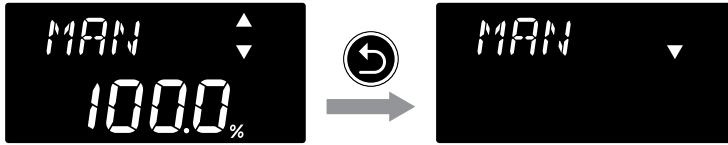

3 Push the key to select the EXT mode and then the key

The pump enters the EXT WAIT mode.

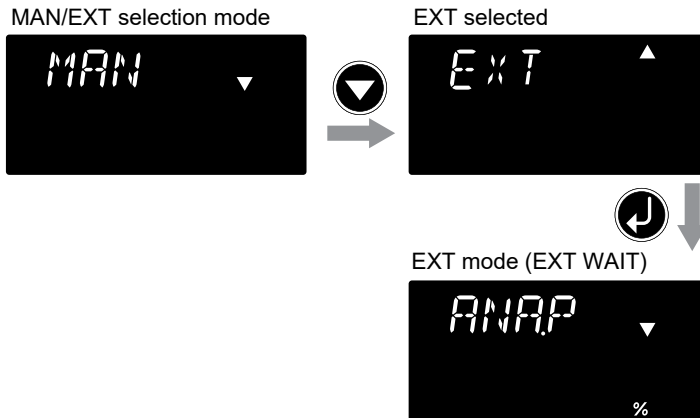

*See page 80 for the EXT mode setting flow chart as well.



4 Push the key to enter the EXT RUN mode

The pump is ready to run with the external analog/pulse signal or the  key (BATCH or INT.B). The green LED bar blinks with every stroke during operation.

*Push the  key to move back to the EXT WAIT mode.

*When the pump is in the ANA.P mode or the ANA.V mode, you can see the amps from the external device with the  key. Get back to the flow unit with the  key.

AUX function

The pump in the MAN RUN mode or the EXT RUN mode operates at the AUX speed while receiving the external signal via the AUX terminal. See page 100. Use this function to prime the pump or to remove entrained air in operation.

*Once the AUX signal is stopped, the mode returns to the MAN speed or continues the programmed EXT mode.

Priming function

This key operation runs the pump at the maximum stroke rate in operation.

1 Press and hold the key more than 3 seconds

The pump runs at the maximum stroke rate while key is pressed in the MAN mode or EXT mode. This function stops automatically in one minute.

MAN WAIT mode



3 sec

Priming speed



Keypad lock

Keypad lock can be active for the prevention of erroneous key operation. The pin code to release the locked keypad is "0000" when shipped from our factory. See page 105 and change the PIN code to your own number.

■ Keypad lock activation

1 Press and hold the key for 3 seconds

The  icon appears on the screen in the MAN mode or EXT mode.

MAN WAIT mode



3 sec

Keypads locked



■ Keypad lock release

1 Push the key to move the PIN code entry screen



Keypads are locked



PIN code entry screen



2 Enter your PIN number

Use the  key to move between digits and  and  keys to change the numeric value.

*The default PIN number is "0000".

3 Push the key

The "PASS" will appear to unlock keypads.

*If the pin number is not correct, "FAIL" will be shown and the lock state will continue.

PIN code entry screen



PASS



■ Emergency stop with keypads locked

1 Press and hold the key for 3 seconds

The pump enters the WAIT mode and stops running with keypad locked. To run the pump again, you will need to enter your PIN code and unlock the keypads.

Unit change

The stroke rate of the pump is shown in % with the factory default setting. Use the  key to cycle through the flow unit from % to *spm*, *mL/min*, *L/h*, or *GPH* based on your application.

■ Stroke rate unit

% indication



Stroke rate shown in between 0.1 and 100.0%.
100.0% is 360spm

spm indication



Stroke rate per minute

■ Flow rate unit

The following flow units are available. See page 68 and perform a calibration in advance.

mL/m indication



Output capacity in milliliter per minute

L/h indication





Output capacity in liter per hour

GPH indication



Output capacity in gallon per hour

Menu mode

Enter the  key to set up the pump. Use the  key to return to the MAN/EXT selection mode to start the operation afterward.

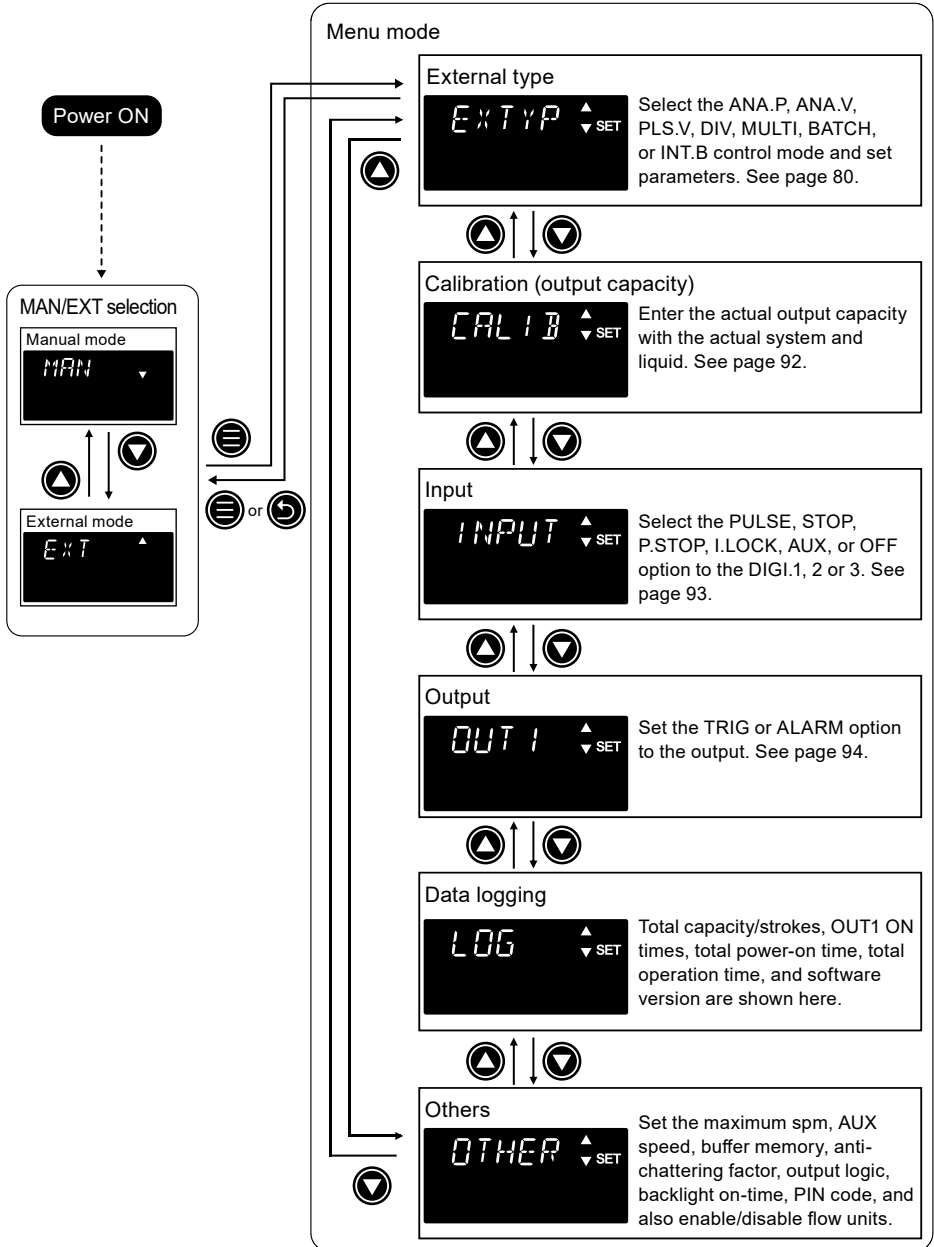

Operation

EXT mode setting

Flow chart

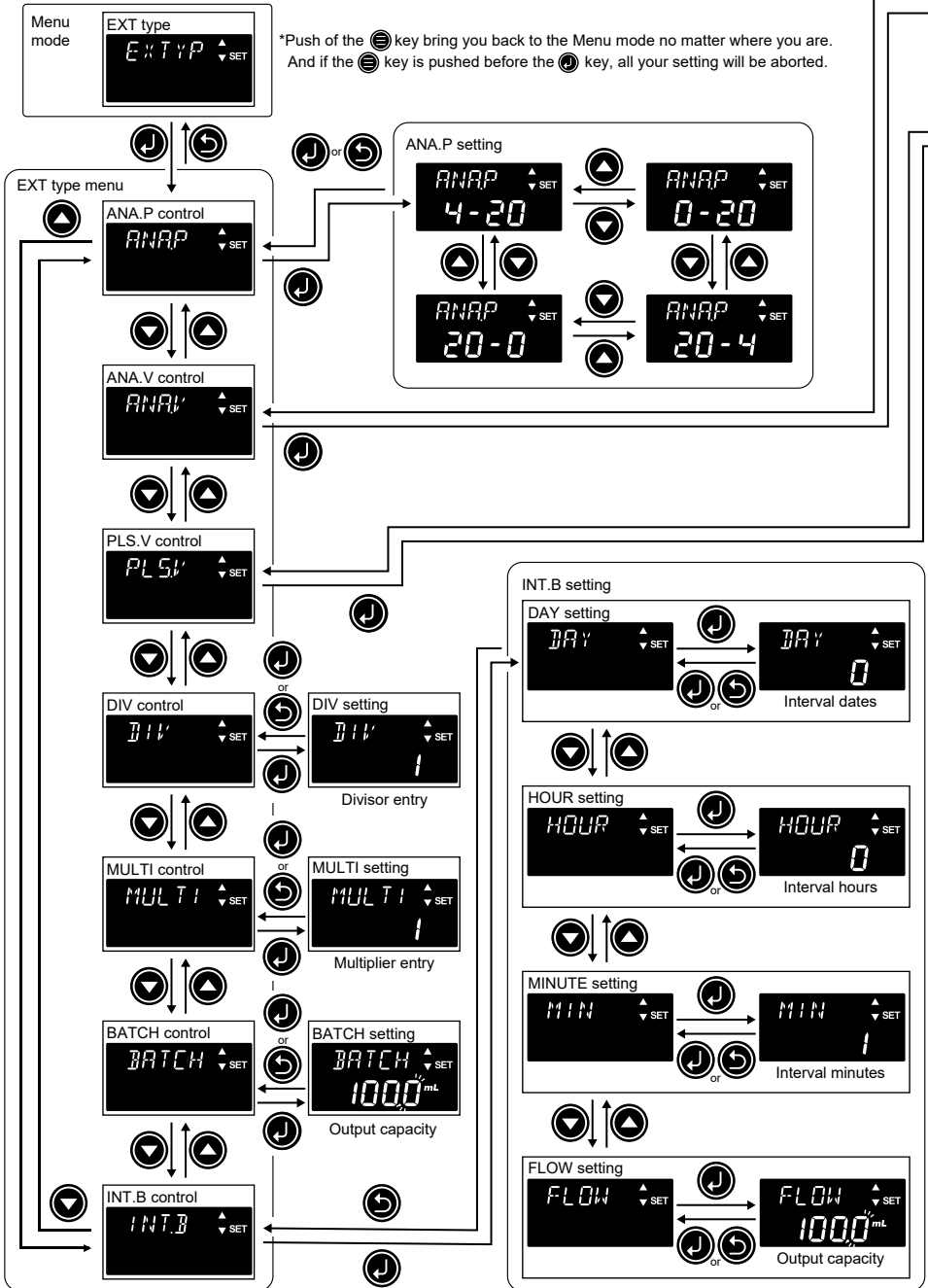

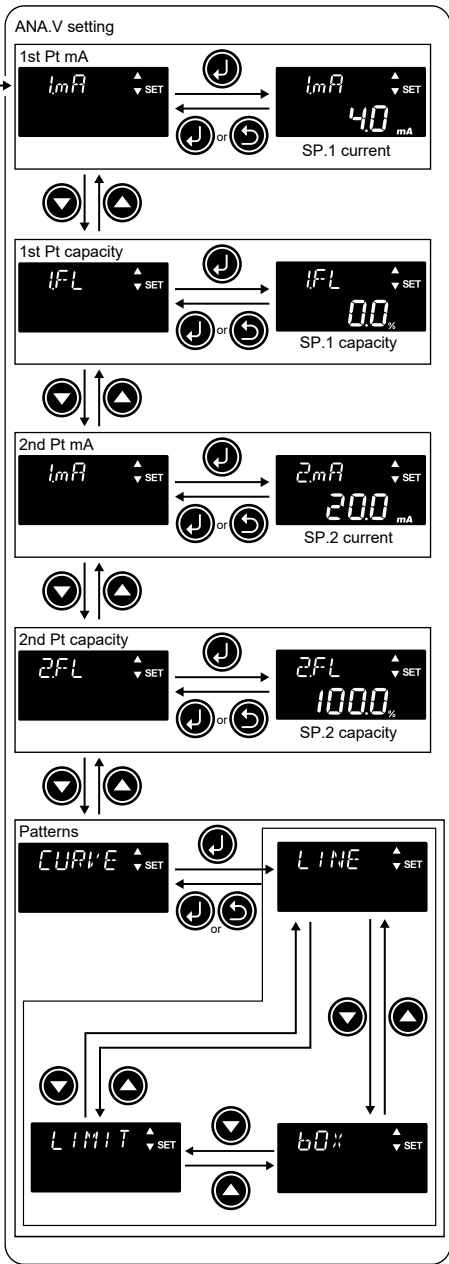
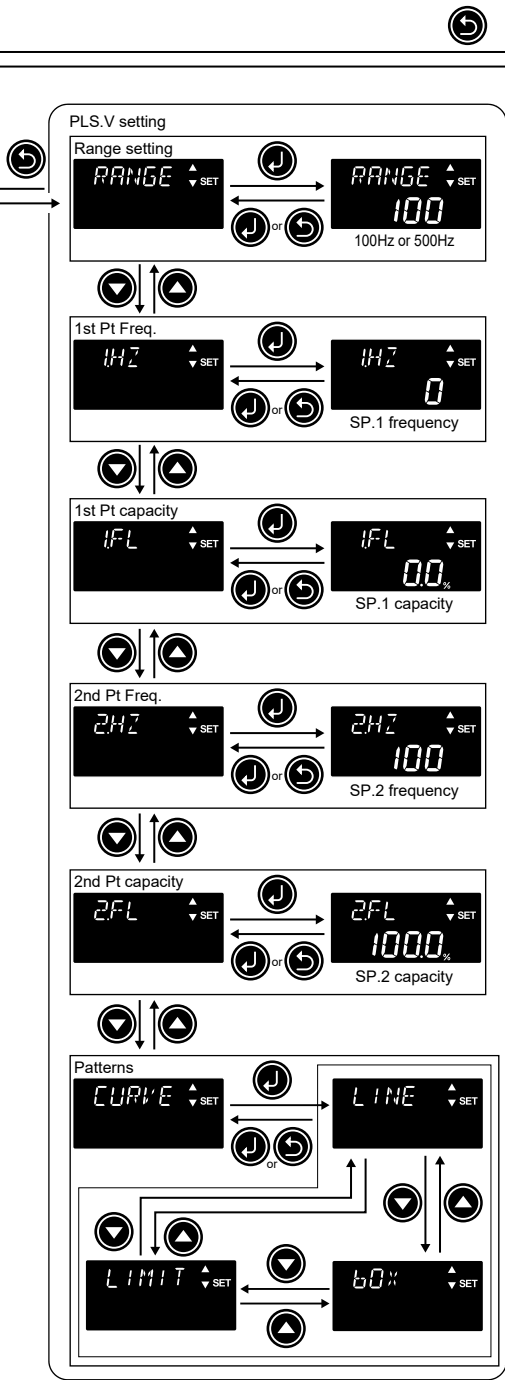



Operation

■ EXT mode setting

Select the control mode from the ANA.P, ANA.V, PLS.V, DIV, MULTI, BATCH, and INT.B, options.

NOTE

Any EXT mode setting will not be entered unless the  key is pushed for confirmation. Also, note if the  key is pushed before the  key, your setting will be aborted.

ANA.P (Analog preset)

1 Enter the menu mode and select the EXTYP option

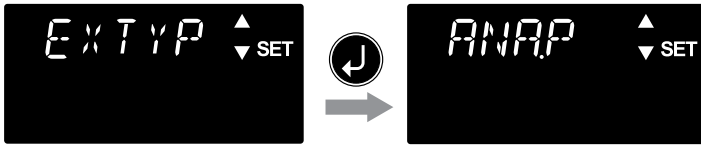

2 Choose the ANA.P option



3 Select a proportional control pattern

Push the  key to confirm your option. See page 28 for the behavior of each pattern.

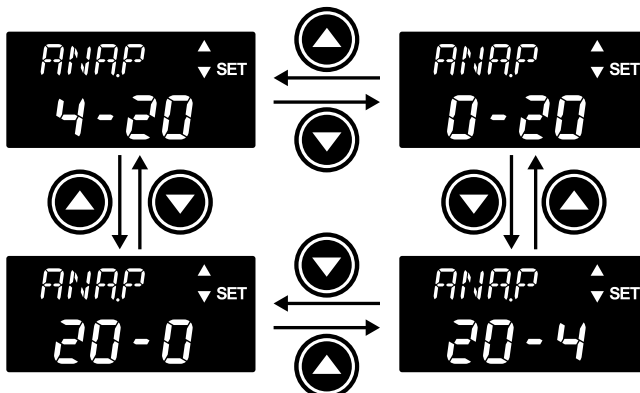

4 Push the  key that brings you back to the Menu mode

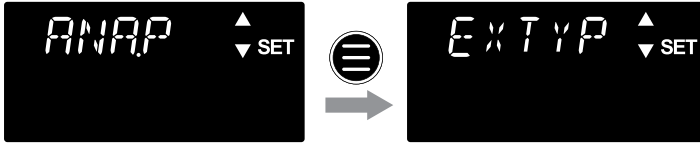

ANA.V (Analog variable)

If you want to use the different flow unit than "%", select the desired flow unit in advance over the MAN WAIT mode or the EXT WAIT mode. Note that the calibration must be performed before selecting the flow unit.

Enter a different value to the setpoint 1 and setpoint 2. If the same value is entered, the display will blink for a few seconds and return to the previous value.

1 Enter the menu mode and select the EXTYP option

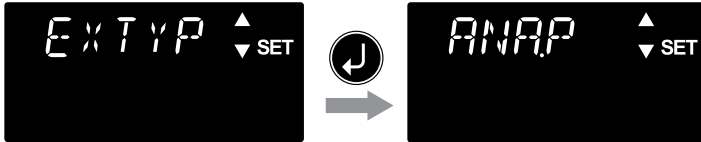

2 Choose the ANA.V option

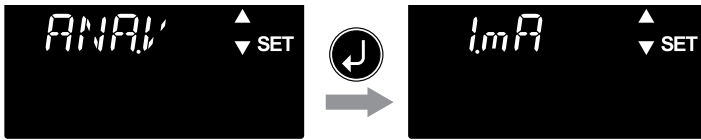

3 Set the 1st input current (mA) to the setpoint 1

Use the ▲ and ▼ keys to adjust and the ⏵ key to confirm the amps. The ⏴ key to move to the next step.

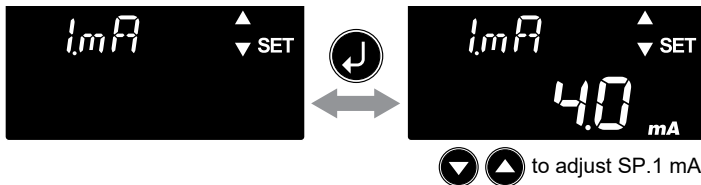

4 Set the 1st stroke rate or output capacity to the setpoint 1

Use the ▲ and ▼ keys to adjust and the ⏵ key to confirm the value. Push the ⏴ key to move to the next step.

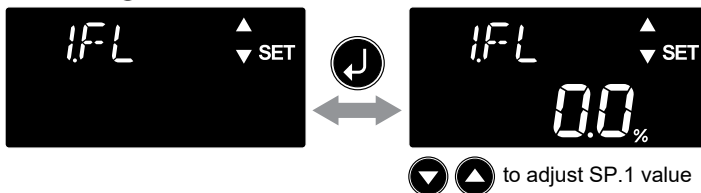

5 Set the 2nd input current and the 2nd stroke rate or output capacity to the setpoint 2 as well

Push the  key to confirm and the  key to move to the next menu.

6 Select the "CURVE" option and determine the operation pattern of the "LINE", "BOX" or "LIMIT"

The  key to confirm your selection. See page 29 for each proportional pattern.

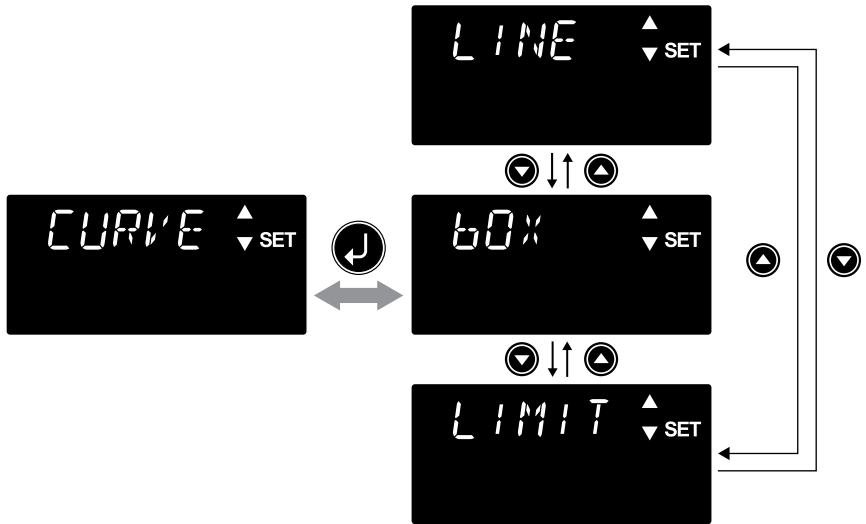

7 Push the  key that brings you back to the Menu mode



Operation

PLS.V (Pulse variable)

If you want to use the different flow unit than "%", select the desired flow unit in advance over the MAN WAIT mode or the EXT WAIT mode. Note that the calibration must be performed before selecting the flow unit.

Enter a different value to the setpoint 1 and setpoint 2. If the same value is entered, the display will blink for a few seconds and return to the previous value.

1 Enter the menu mode and select the EXTYP option



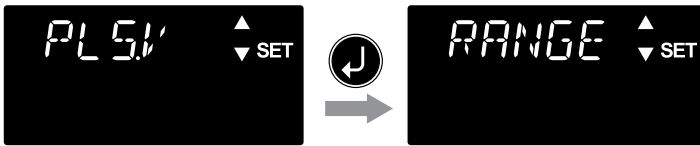

2 Choose the PLS.V option

The PULSE option is automatically selected to the DIGI.1 input.







3 Select the pulse frequency range (Hz) based on the input device

Select the 100Hz range or 500Hz based on the input device you use. Push the  key to confirm the selection and the  key to move to the next step.



4 Set the 1st pulse frequency (Hz) to the setpoint 1

Use the  and  keys to adjust and the  key to confirm the Hz. Push the  key to move to the next step.



5 Set the 1st output capacity to the setpoint 1

Use the ▲ and ▼ keys to adjust and the ↵ key to confirm the capacity. Push the ▶ key to move to the next menu.

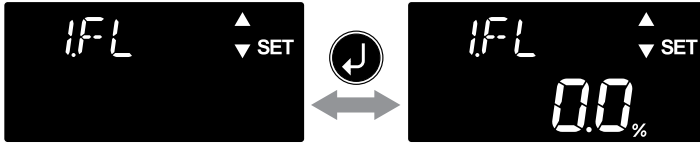

6 Set the 2nd pulse frequency and the 2nd output capacity to the setpoint 2 as well

Push the ↵ key to confirm and the ▶ key to move to the next menu.

7 Select the "CURVE" option and determine the operation pattern of the "LINE", "BOX" or "LIMIT"

The ↵ key to confirm your selection. See page 30 for each proportional pattern.

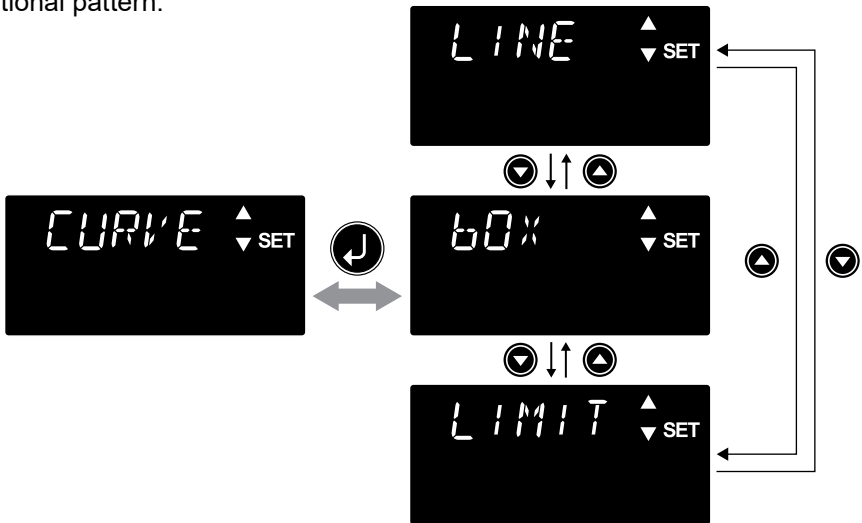

8 Push the ☰ key that brings you back to the Menu mode



DIV (Divisor)

- 1 Enter the menu mode and select the EXTYP option

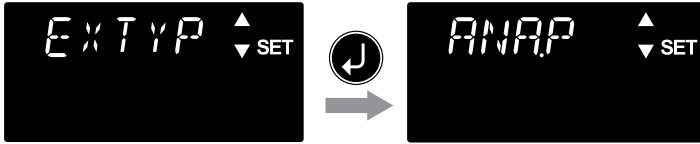

- 2 Choose the DIV option

The PULSE option is automatically selected to the DIGI.1 input here.

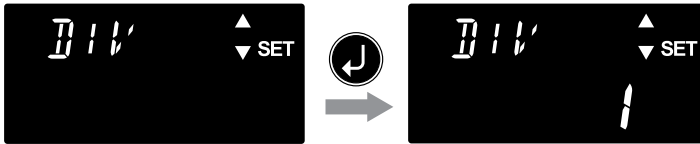

- 3 Set the divisor that corresponds to one stroke

Use the ▲ and ▼ keys to select and the ⏵ key to confirm the divisor.
See page 31 for the setting example.



- 4 Push the ⏴ key that brings you back to the Menu mode



MULTI (Multiplier)

- 1** Enter the menu mode and select the EXTYP option

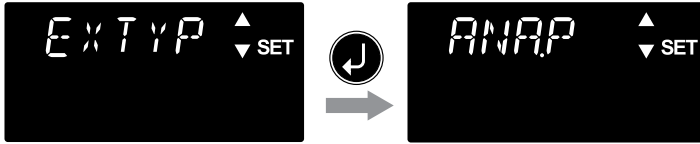

- 2** Choose the MULTI option

The PULSE option is automatically selected to the DIGI.1 input here.



- 3** Set the multiplier that multiplies the pump stroke

Use the ▲ and ▼ keys to select and the ⏵ key to confirm the multiplier.
See page 31 for the setting example.



- 4** Push the ☰ key that brings you back to the Menu mode



BATCH (Batch)

The batch completion alarm can be enabled. See page 94 as well. If you want to use the different flow unit than "%", select the desired flow unit in advance over the MAN WAIT mode or the EXT WAIT mode. Note that the calibration must be performed before selecting the flow unit.

1 Enter the menu mode and select the EXTYP option

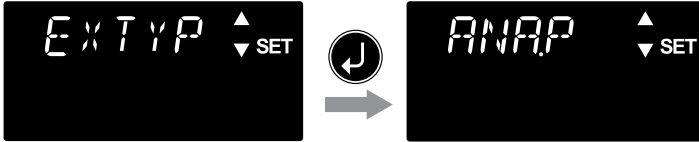





2 Choose the BATCH option

The PULSE option is automatically selected to the DIGI.1 input here.



3 Set the batch volume

Use the  key to move between the digits, the  and  keys to change and the  key to confirm the value. See page 32 for the setting example.



4 Push the key that brings you back to the Menu mode



INT. B (Interval batch)

If you want to use the different flow unit than "%", select the desired flow unit in advance over the MAN WAIT mode or the EXT WAIT mode. Note that the calibration must be performed before selecting the flow unit.

1 Enter the menu mode and select the EXTYP option

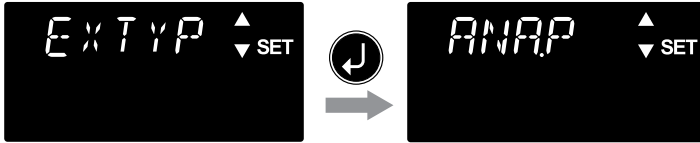

2 Choose the INT. B option

The PULSE option is automatically selected to the DIGI.1 input here.



3 Set the interval between the batch volume

Use the ▲ and ▼ keys to select the DAY (0 to 9 days), HOUR (0 to 23 hours), and MIN (0 to 59 minutes) fields and the ⏵ key to confirm. Use the ▲ and ▼ keys to change and the ⏵ key to confirm the interval. See page 34 for the setting example.



4 Set the batch volume

Use the ▲ and ▼ keys to select the FLOW and the ⏵ key to confirm. Use the ⇄ key to move between the digits, the ▲ and ▼ keys to change and the ⏵ key to confirm the value.

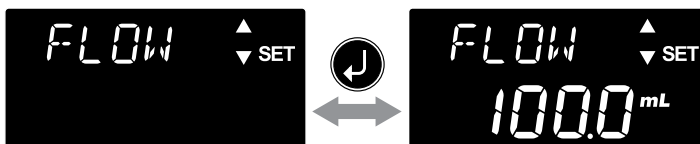

5 Push the  key that brings you back to the Menu mode



Calibration

See the Perform a Calibration section on page 68 as well.

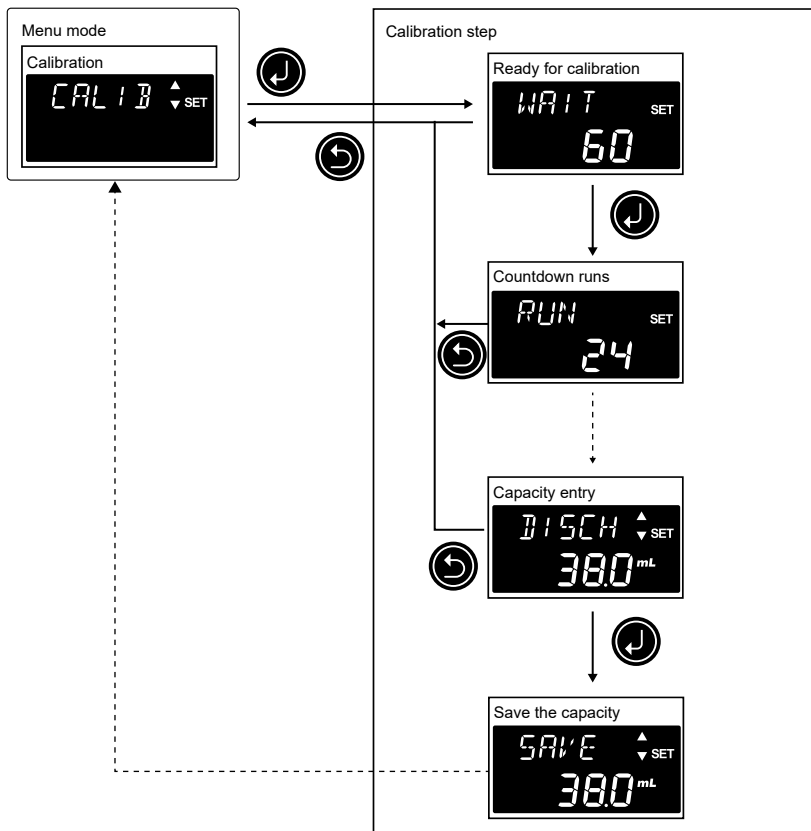

Input setting

Set the PULSE (DIGI.1 only), STOP, PreSTOP, I.LOCK, AUX, or OFF option to the DIGI.1, 2, or 3 input of the menu mode. The digital 1, 2, or 3 input of the pump terminal must be electrically connected with an external device correspondingly to the option you will set here. See page 52 for the Signal wire connection also.

*The PULSE option that is used for the PLS.V, DIV, MULTI, BATCH, and INT.B control modes can be selected only to DIGI.1 input of the menu mode.

*The I.LOCK (Interlock) signal takes precedence over the STOP, AUX, and PreSTOP signals. The STOP takes precedence of the AUX and PreSTOP signals, and the AUX the PreSTOP signal.

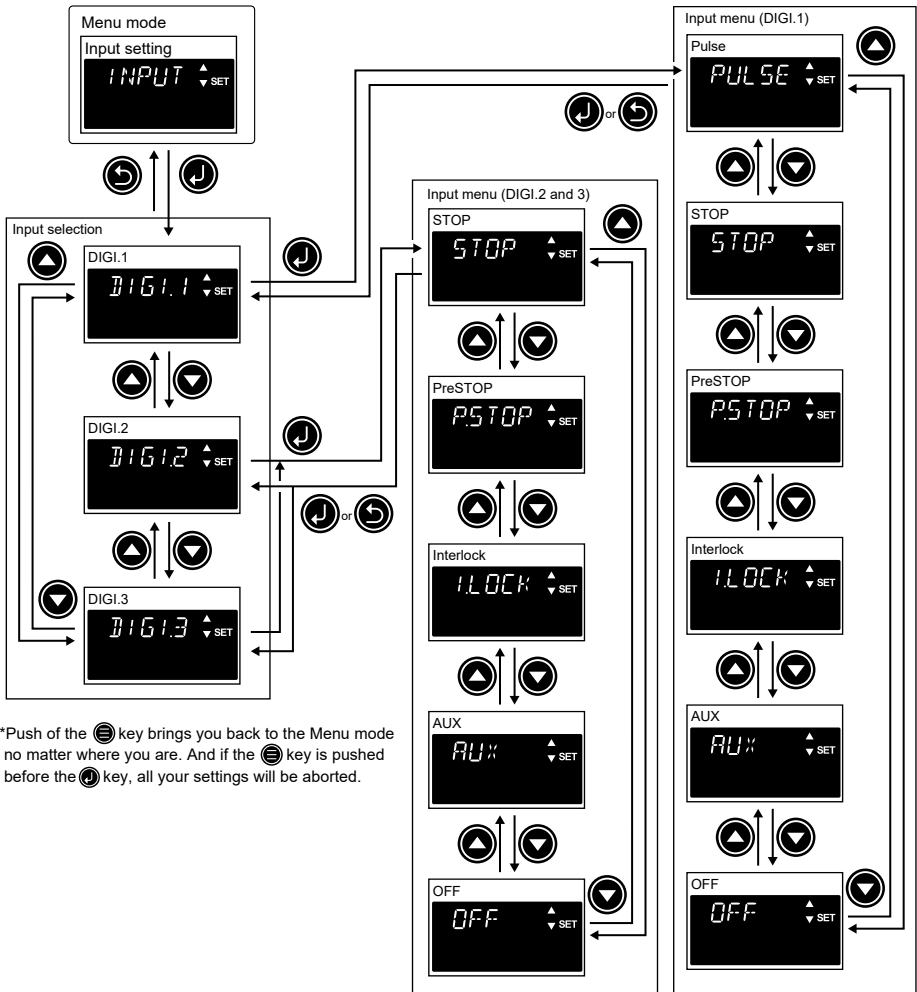

*Push of the key brings you back to the Menu mode no matter where you are. And if the key is pushed before the key, all your settings will be aborted.

Output setting (photocoupler: open collector)

To enable the OUT 1, enter the menu mode and select the trigger option. Select the SPM to output the pulse signal simultaneously with the pump strokes, select the ALARM to output an alarm signal at the STOP, PreSTOP, Interlock, or B.COMP state, or select the STATE to output the signal that lets you know whether the pump is running or not (The STATE signal pauses when the pump is in MAN/EXT selection mode, WAIT mode or when the pump is paused by the STOP and I.LOCK signal.).

Options	Alarm outputs when:
STOP	The pump receives the STOP signal.
P.STOP (Pre-STOP)	The pump receives the Pre-STOP signal.
I.LOCK (Interlock)	The pump receives the interlock signal.
B.COMP (Batch Complete)	The pump has completed the batch volume (BATCH only).

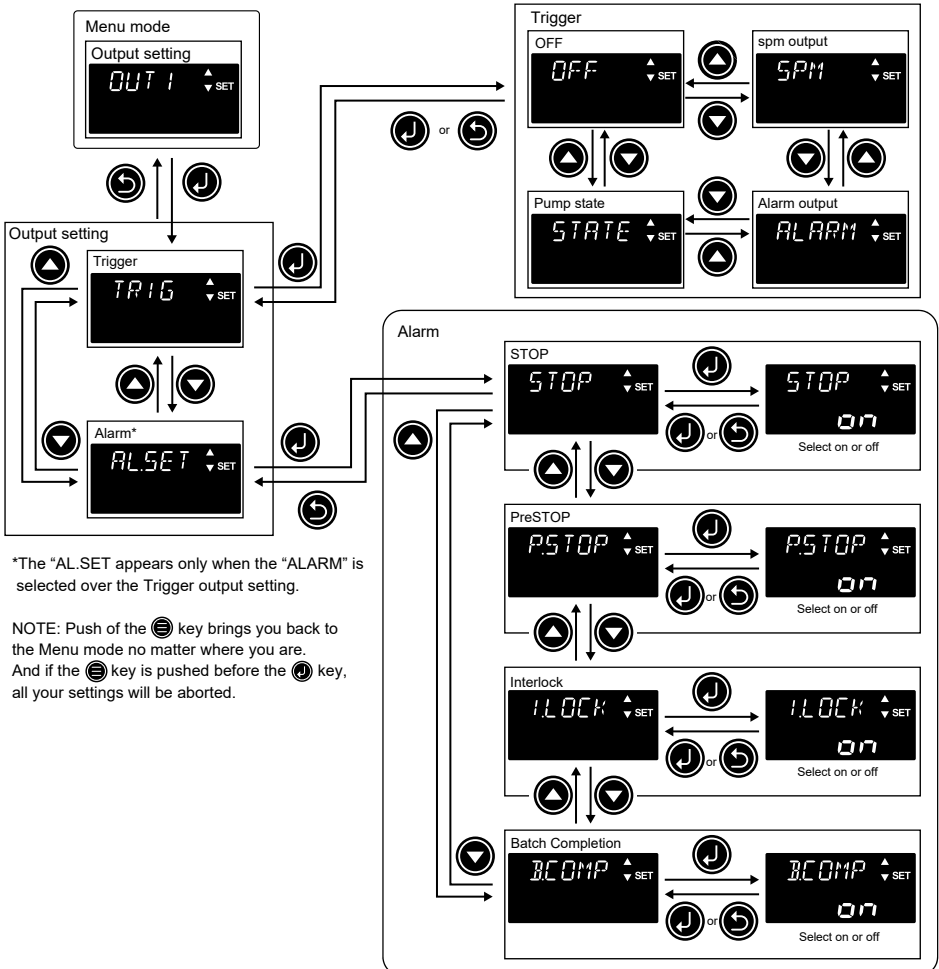

■ Target setting

1 Enter the menu mode and select the OUT 1 option

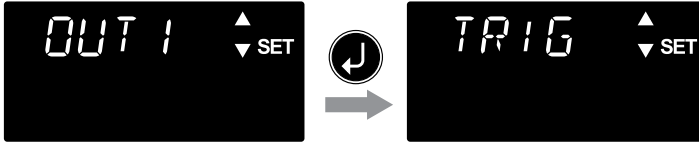

2 Choose the TRIG and then the SPM, ALARM, STATE or OFF option

*Selecting those option will be simply set with the  key. Selecting the OFF option disables the output.

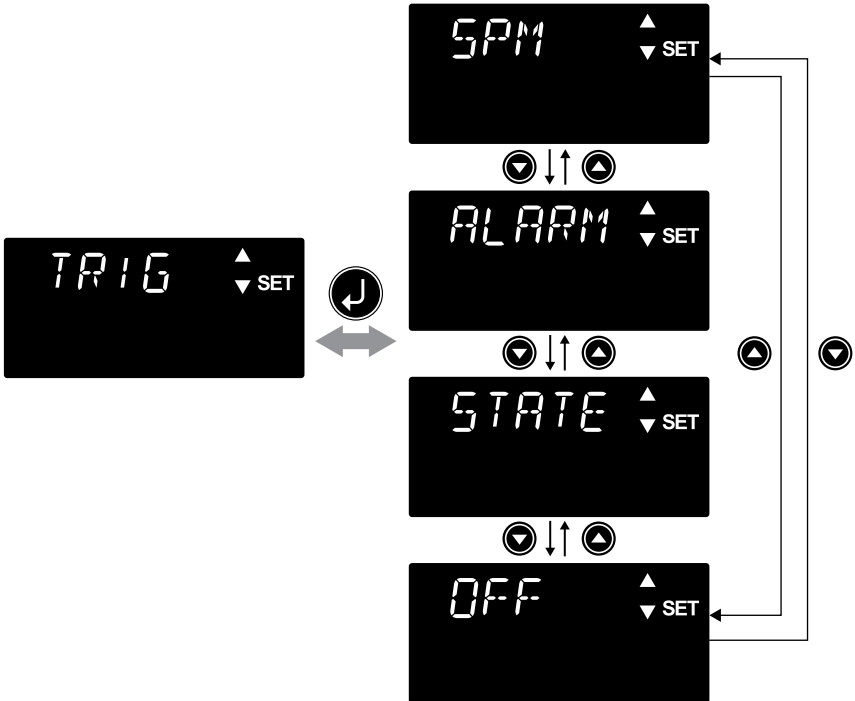

■ Alarm setting

If the ALARM option is selected:

- 1 Use the ▲ and ▼ keys to select the AL.SET and push the ⏵ key

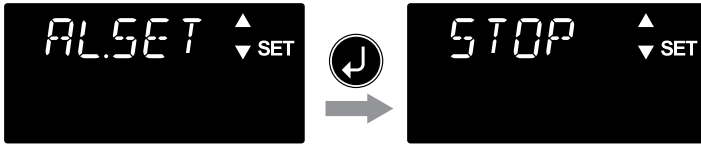

- 2 Enable or disable the STOP, P.STOP, I.LOCK, or B.COMP option
Push the ⏵ key once. Select and enable or disable the signal type that triggers the alarm output. Push the ⏵ key once again to confirm the choice and then the ⏴ key.

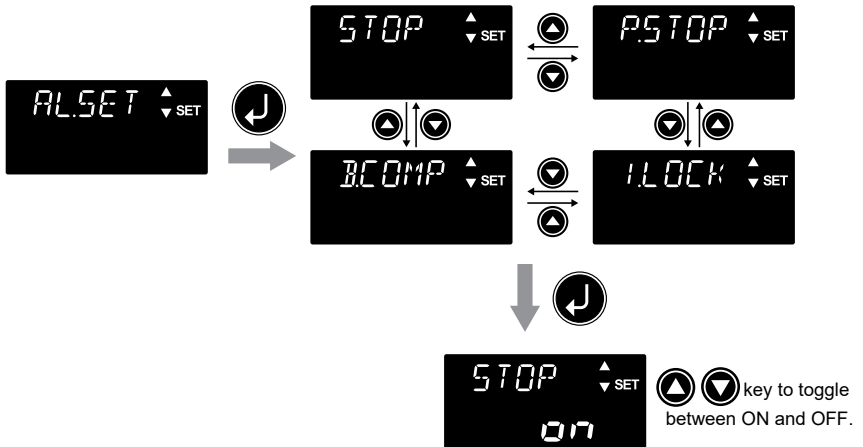

- 3 Push the ≡ key that brings you back to the Menu mode



Data logging

Data logs show the total capacity of the pump, the total strokes of the pump, the OUT1 ON times, the total power-on time, the total operation time, and the software version.

If the  key is depressed for three seconds at any log menu, you can reset that log.

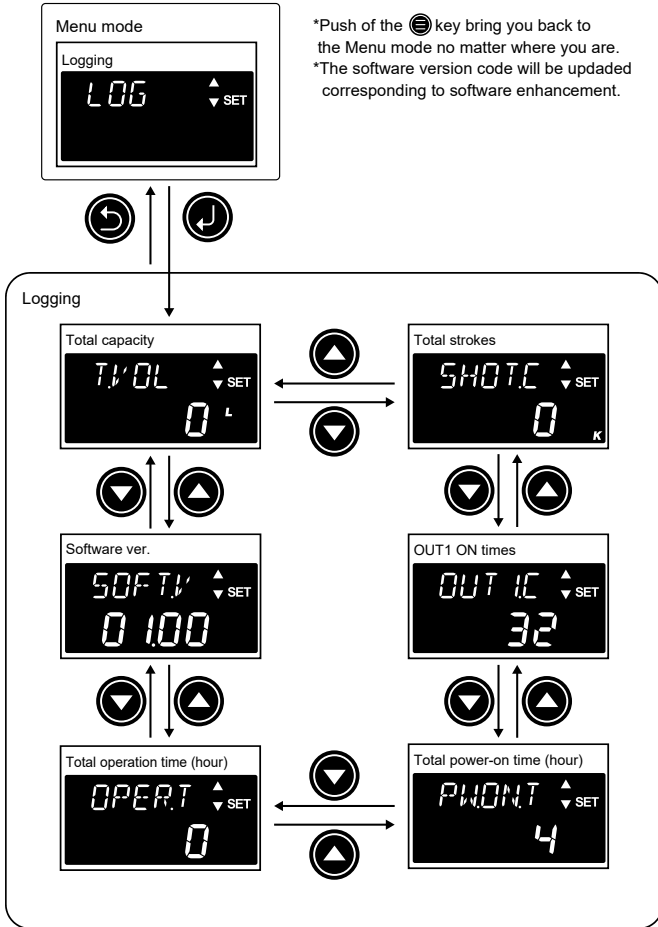

Other setting

■ Flow chart

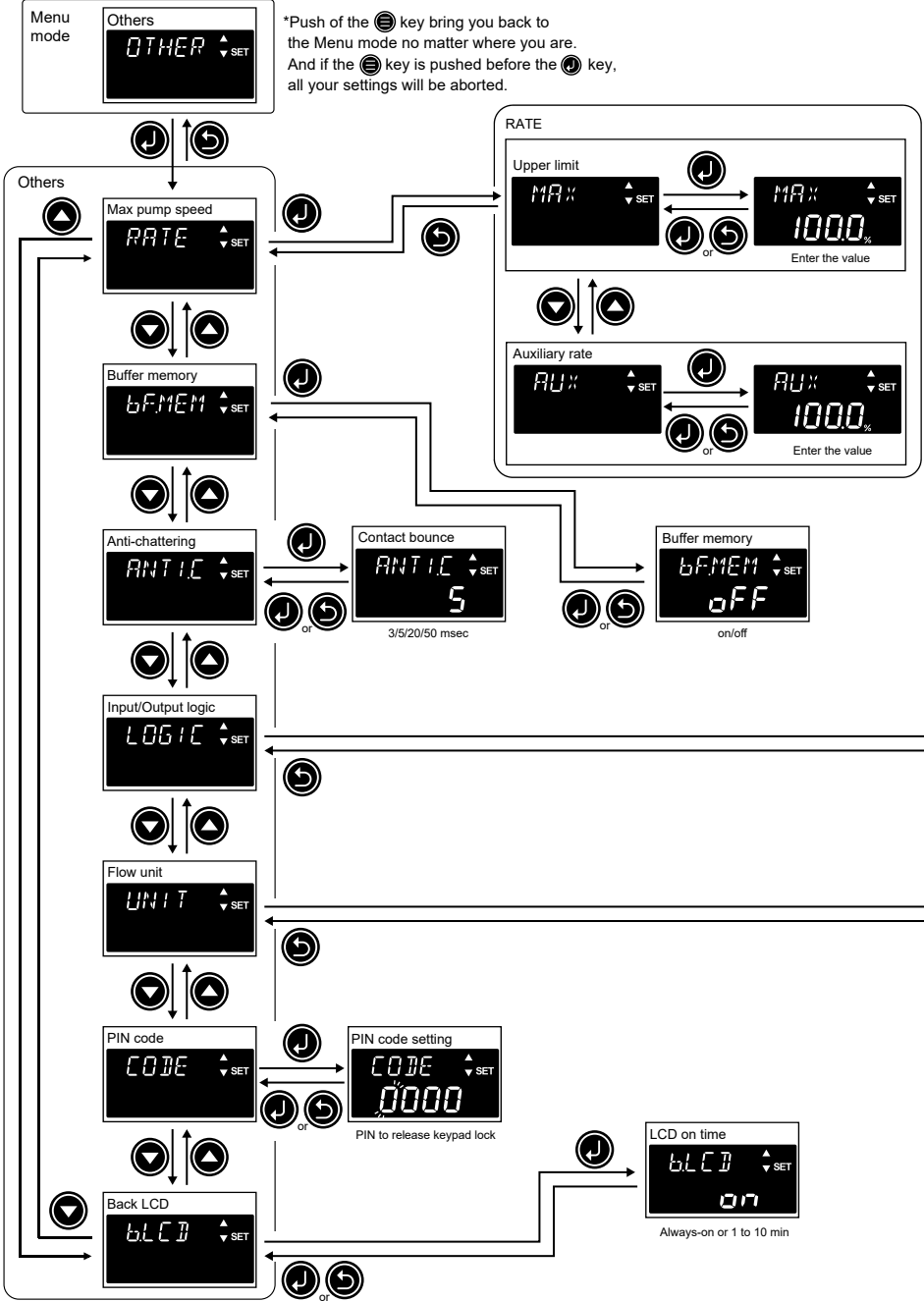

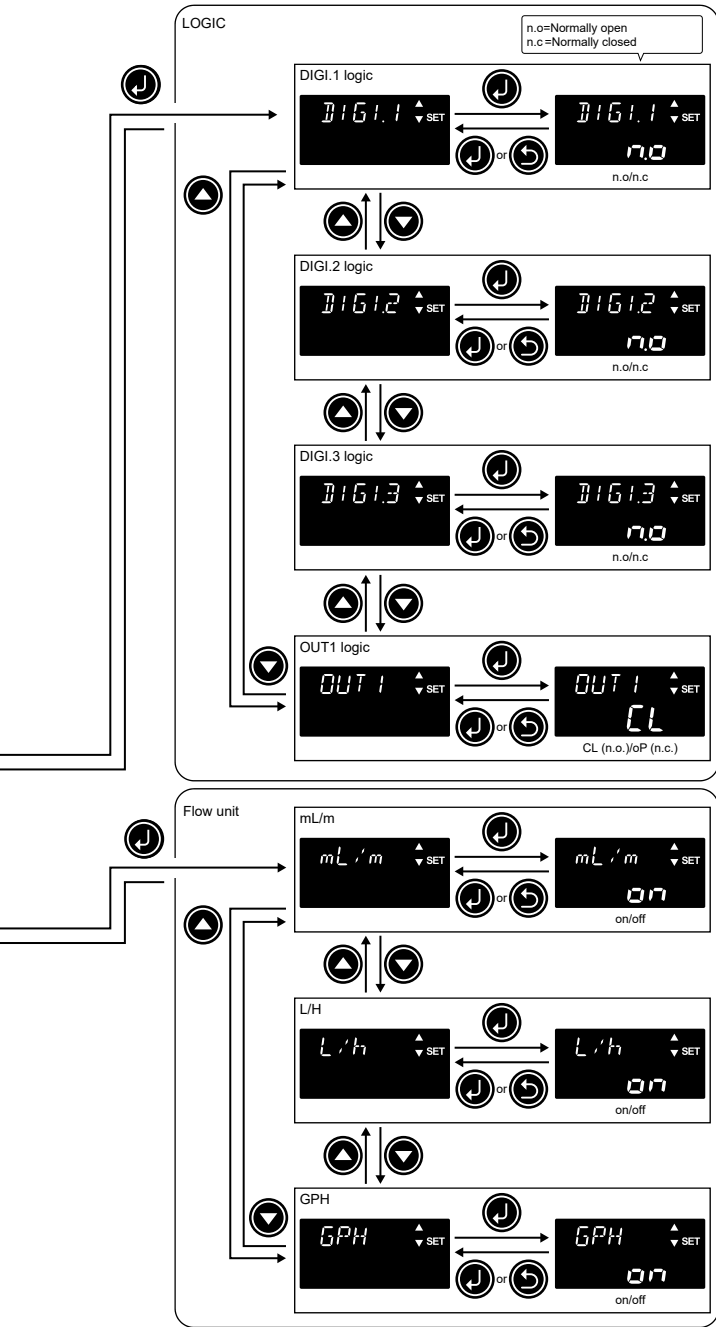



Operation

■ Other setting

The MAX pump speed, AUX speed, buffer memory, anti-chattering, input/output logic, flow unit, PIN code, and backlight LCD on time.

NOTE

The other settings will not be entered unless the  key is pushed for confirmation. Note if the  key is pushed before the  key, your setting will be aborted.

RATE (Upper limit spm)

- 1** Enter the menu mode and select the OTHER option





- 2** Choose the RATE option

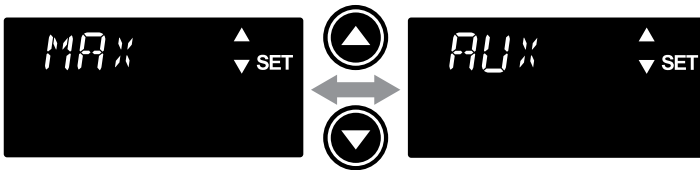

- 3** Select the MAX or AUX option and push the  key

The MAX represents the MAN/EXT/Priming speeds, and the AUX represents the AUX speed individually.



- 4** Use the  and  keys to adjust the MAX or AUX speed

If you want to use the different flow unit than "%", select the desired flow unit in advance over the MAN WAIT mode or the EXT WAIT mode.



5 Push the key to confirm the setting

bF.MEM (Buffer memory)

Enable or disable the buffer memory based on your application. The buffer memory can be used for the DIV, MULT, and BATCH control modes.

1 Enter the menu mode and select the OTHER option

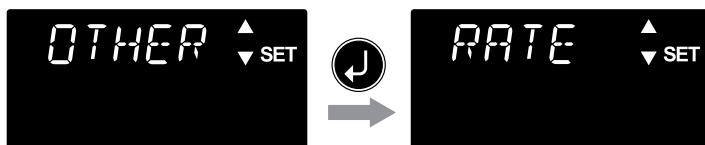

2 Choose the bF.MEM option

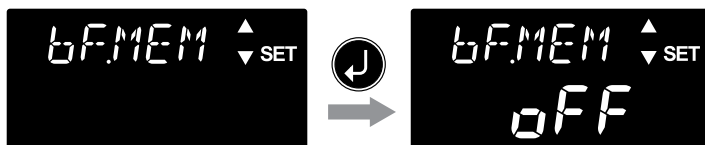

3 Select the "on" or "of" option

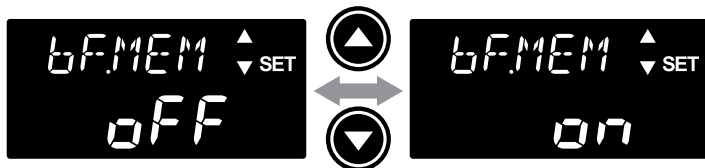

4 Push the key to confirm the setting

ANTI.C (Anti-chattering)

Set the bounce threshold based on the actual pulse width (ON time) in order to prevent the adverse effect of chattering (contact bounce) and electrical noise.

- 1** Enter the menu mode and select the OTHER option



- 2** Choose the ANTI.C option



- 3** Select the best bounce threshold

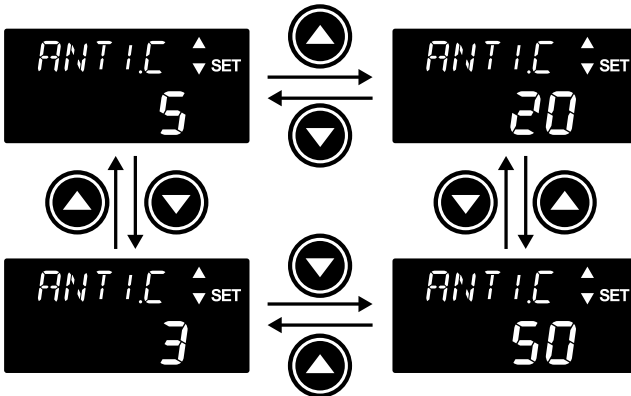

- 4** Push the  key once to confirm the setting

LOGIC (Input/Output logic)

Select the "n.o" (the factory default setting) or the "n.c" option to the DIGI.1, DIGI.2, or DIGI.3 input to determine whether the pump runs or stops based on the external signal to the EXT IN/OUT terminal or the EXT IN terminal. With the "STOP" function and the "n.o" options set to an input, for example, the pump stops while that input is receiving the external signal (normally-open contact). With the "STOP" and the "n.c", the pump runs while receiving the signal (normally-closed contact).

Also, select the "CL (factory default)" or the "oP" logic to the OUT 1 output that activates an external device or alarm. With the "ALARM" option and the "CL" selected to the OUT1, the "NO" contact closes while the output terminal sends the alarm signal to the device. With the "ALARM" and "oP" selected, the "NC" contact opens while the terminal sends the alarm signal to the device.

1 Enter the menu mode and select the OTHER option

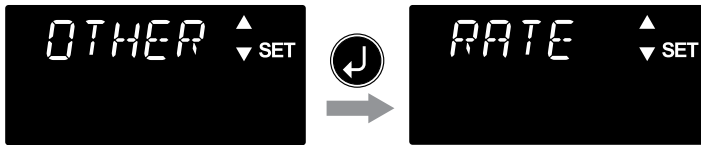

2 Choose the LOGIC option



3 Select the DIGI or OUT option and push the key

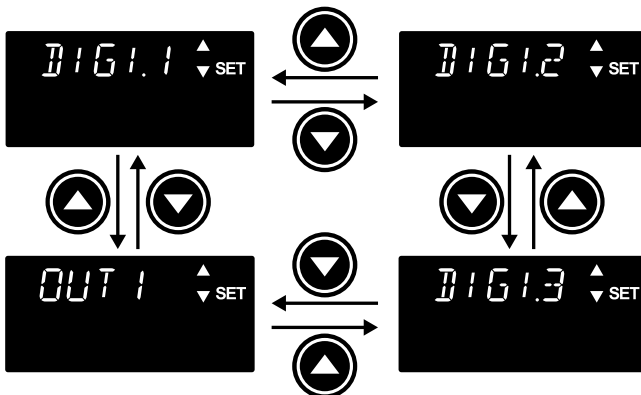

- 4** Set the "n.o" (normally-open) or "n.c" (normally-closed) to the input or "CL" (normally-open) or "oP" (normally-closed) to the output

Input logic



Output logic



- 5** Push the  key once to confirm the setting

UNIT (Flow units)

Enable the flow unit which you use and turn off others.

- 1** Enter the menu mode and select the OTHER option



- 2** Choose the UNIT option



- 3** Select the units you will enable or disable and press the  key

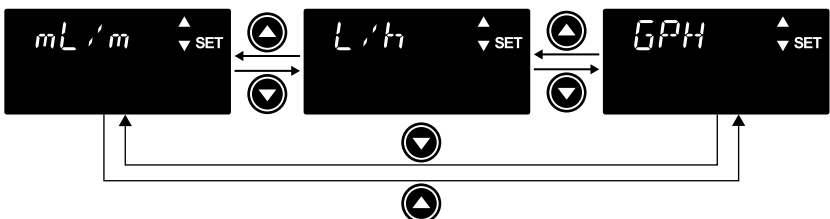

4 Select on or off for the chosen unit



5 Push the  key to confirm the setting

CODE (PIN number entry)

A PIN is required to release a keypad lock state.

*The default setting is "0000".



1 Enter the menu mode and select the OTHER option



2 Choose the CODE option



3 Enter the new PIN code

Use the  key to move between the digits,  and  keys to change the value.

4 Push the  key to confirm the setting

b. LCD (Backlight LCD on time)

Set the on time of the backlight LCD.

1 Enter the menu mode and select the OTHER option

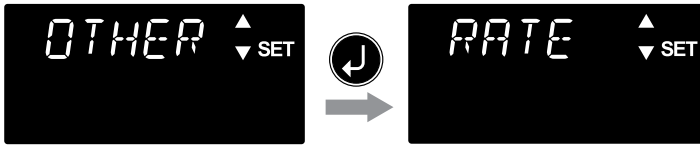

2 Choose the b.LCD option



3 Enter the on time

Use the ▲ and ▼ keys to select 1 to 10 minutes for the LCD to light and then automatically goes off.

*The "on" option is "Always-on".

4 Push the ⏵ key to confirm the setting

Maintenance

This section describes troubleshooting, inspection, wear part replacement, exploded views and specifications.

! Important

- Follow instructions in this manual for replacement of wear parts. Do not disassemble the pump beyond the extent of the instructions.
- Always wear protective clothing such as an eye protection, chemical resistant gloves, a mask and a face shield during disassembly, assembly or maintenance work. The specific solution will dictate the degree of protection. Refer to SDS precautions from the solution supplier.
- Risk of electrical shock. Be sure to turn off power to stop the pump and related devices before service is performed.

Before unplugging the pump

Always stop the pump by key operation. And wait for three seconds before unplugging the pump. Otherwise, the last key operation to stop the pump may not be put in memory. In this case the pump unintentionally starts to run as powered on, discharging liquid.

NOTE

- It's not the manufacturer's responsibility for any failure due to corrosion or erosion occurred in your operating condition.
- For the need of repair, contact your distributor of Iwaki or the manufacturer of equipment in which our product is built.
- Be sure to drain chemicals and flush the inside of the pump before return so that a harmful chemical does not spill out in transit.

Troubleshooting

First check the following points. If the following measures do not help remove problems, contact us or your nearest distributor.

States	Possible causes	Solutions
The pump does not run. (LED does not light. Blank screen.)	Power voltage is too low.	<ul style="list-style-type: none"> Observe the allowable voltage range of 90-264VAC.
	The pump is not powered.	<ul style="list-style-type: none"> Check the switch if it is installed. Correct wiring. Replace a broken wire to new one.
Pump does not prime.	Pump is air locked.	<ul style="list-style-type: none"> Prime pump per instructions. See page 58.
	Air in suction tubing.	<ul style="list-style-type: none"> Reroute suction tubing to eliminate air trap.
	A valve set is installed upside down.	<ul style="list-style-type: none"> Reinstall the valve set.
	Valve gasket is missing.	<ul style="list-style-type: none"> Install valve gasket.
	Foreign matters are stuck in the valve ball in the pump head.	<ul style="list-style-type: none"> Take apart, inspect and clean the valves. Replace as necessary.
	A valve ball is stuck on a valve seat.	<ul style="list-style-type: none"> Take apart, inspect and clean the valve. Replace as necessary.
Output fluctuates.	Air is trapped in the pump.	<ul style="list-style-type: none"> Prime pump per instructions. See page 58.
	Overfeeding	<ul style="list-style-type: none"> Purchase separately and mount the check valve. See page 47.
	Foreign matters are stuck in the valve ball in the pump head.	<ul style="list-style-type: none"> Take apart, inspect and clean the valves. Replace as necessary.
	Diaphragm is damaged.	<ul style="list-style-type: none"> Replace diaphragm. See page 117.
	Pressure fluctuates at an injection point.	<ul style="list-style-type: none"> Maintain a pressure constant at an injection point by optimizing tubing or by relocating the point.
Liquid leaks.	The fitting, the fitting nut or the air vent body is loose.	<ul style="list-style-type: none"> Retighten them.
	Pump head is loose.	<ul style="list-style-type: none"> Retighten the pump head bolts. See page 56 for the rated torque.
	O rings or valve gaskets are missing.	<ul style="list-style-type: none"> Install O rings and valve gaskets in place.
	Diaphragm is damaged.	<ul style="list-style-type: none"> Replace diaphragm. See page 117.
	Excessive discharge pressure.	<ul style="list-style-type: none"> Check that the discharge line is not closed. Check if tubing is not clogged.

Inspection

Perform daily and periodic inspection to keep pump performance and safety.

Daily inspection

Check the following points. If you notice any abnormal or dangerous conditions, suspend operation immediately and inspect/solve problems. See the troubleshooting section as necessary.

When wear parts come to the life limit, replace them with new ones. Contact us or your nearest distributor for detail.

No.	States	Points to be checked	How to check
1	Pumping	• If liquid is pumped.	Flow meter or visual inspection
		• If the suction and discharge pressure are normal.	Check specifications.
		• If liquid has deteriorated, crystallized or precipitated.	Visual or audio inspection
2	Noise and vibration	• If abnormal noise or vibration occurs. They are signs of abnormal operation.	Visual or audio inspection
3	Air ingress from pump head joints and the suction line	• If pumped liquid includes air bubbles, check the line for leakage and loose connection and retighten as necessary.	Visual or audio inspection

Periodic inspection

Retighten the pump head bolts evenly to the following torque in diagonal order.

*Head bolts may loosen in operation. How fast the bolts start to loosen is depending on operating conditions.

Tightening torque

Model code	Torque	Bolts
EWP-038B/-080C/-130D/-270E	19.12 lb-in (2.16 N•m)	M4 hex. socket head bolt
EWP-410F/-420F	22.57 lb-in (2.55 N•m)	M5 hex. socket head bolt

*A hexagon wrench can be used for a torque wrench. See page 57.

Wear part replacement

To run the pump for a long period, wear parts need to be replaced periodically. It is recommended that the following parts are always stocked for immediate replacement. Contact us or your nearest distributor for detail.

! Precautions

- Solution in the discharge line may be under pressure. Release the pressure from the discharge line before disconnecting plumbing or disassembly of the pump to avoid solution spray.
- Rinse wet ends thoroughly with tap water.
- Each time the pump head is taken apart, replace the diaphragm, O rings, and valve sets with new ones.

Wear part list

Parts			# of parts	Estimated life
Valve set	VC/VS/VE/PC/ PS/PE/TC	FC	2 sets	8000 hours
Diaphragm			1	
O ring	<p>(except the FC and SH types)</p>		See page 121 to 123.	

*Wear part duration varies with the pressure, temperature and characteristics of liquid.

*The estimated life is calculated based on the continuous operation with clean water at ambient temperature.

Before replacement

First release pressure from the pump head and the discharge line.

1 Stop the pump operation

2 Rotate the adjusting screw two revolutions counterclockwise to open the air vent port

NOTE

Do not rotate it three revolutions from the closed position. Or liquid may come out from the adjusting screw.

*The air vent adjusting screw is NOT provided to the pumps with the FC wet end code. Establish an air vent line with an air vent valve and adjust the valve manually to expel gas from the pump and system before operation (see the sketch on page 61 as well.). In the case the air vent line is unable to be built, you have no choice but to remove the discharge line while it is under pressure. This is not totally recommended; however, use a cloth around the fitting nut of the check valve several times until it can be a protection against solution spray and the check valve is safely removed from the discharge tube.

3 Check the pump head and the discharge line are depressurized

Liquid pressure is released from the air vent line in the form of solution spray.

NOTE

If pressurized liquid is not expelled, run the pump with an opened air vent line until pressure is removed.

Valve set replacement

■ Discharge valve set disassembly/assembly

Necessary tools

- An 1.5" (38mm) or wider adjustable wrench
- A pair of tweezers

*Unfix the pump base before disassembly.

1 Remove the fitting nut, the discharge tube, and the air bleed tube

NOTE

Rinse chemicals or crystals off the parts as necessary.

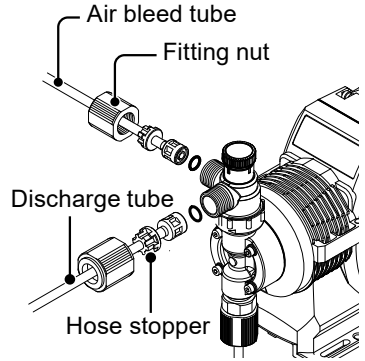

2 Turn the lock nut counterclockwise and remove the air vent body A

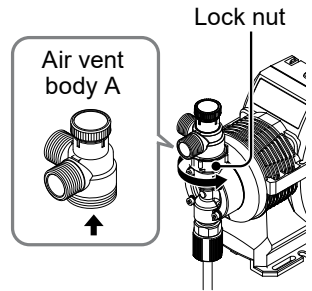

3 Use an adjustable wrench and remove the air vent body B

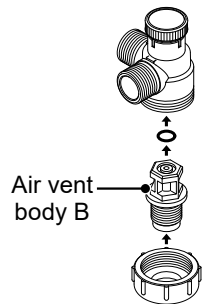

4 Pull out the valve set with a pair of tweezers

5 Build up the new valve set into the pump head and hand-tighten the air vent body B through the lock nut as far as it will go. Re-tighten the air vent body B by a further 90° with an adjustable wrench

*There are many small parts in the liquid end. These parts must be installed correctly for proper operation of the pump (no leak or good pump output). Be sure both valve seats are in the same orientation. See the exploded view pages, also.

*Be sure to fit O rings and gaskets are in place.

*Keep the valve set clean.

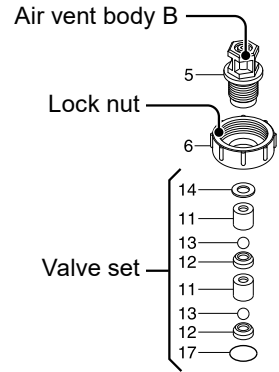

6 Remount the air vent body A using the lock nut and connect tubes

EWP-038B/-080C/-130D/-270E/-410F FC

1 Remove the pipe

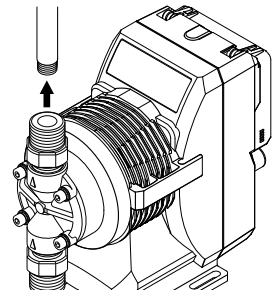

2 Use an adjustable wrench and remove the fitting

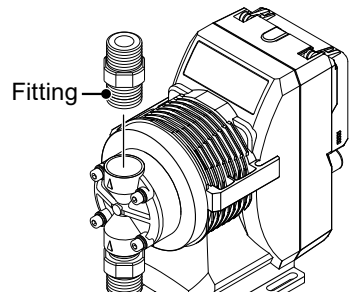

3 Pull out the valve set with a pair of tweezers

4 Build up the new valve set into the pump head and hand-tighten the fitting as far as it will go. Retighten it by a further 90° with an adjustable wrench

*There are many small parts in the liquid end. These parts must be installed correctly for proper operation of the pump (no leak or good pump output). Be sure both valve seats are in the same orientation.

See the exploded view pages, also.

*Be sure to fit gaskets are in place.

*Keep the valve set clean.

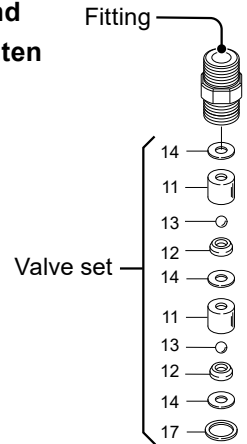

5 Remount the pipe

EWP-038B/-080C/-130D/-270E/-410F SH

1 Remove the discharge pipe and the air bleed tube

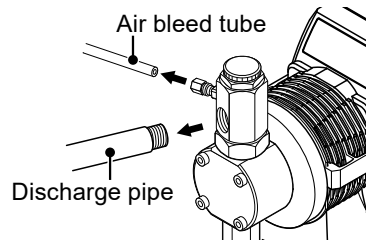

2 Use an adjustable wrench to remove the lock nut and the air vent body A

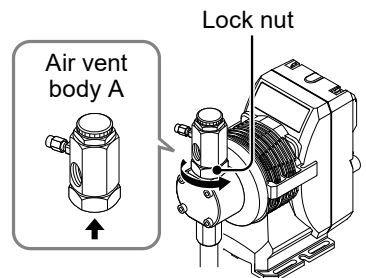

3 Use an adjustable wrench and remove the air vent body B

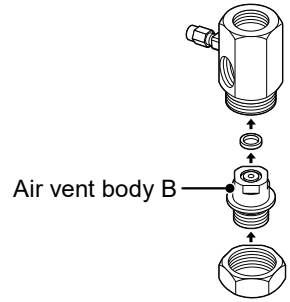

4 Pull out the valve set with a pair of tweezers

5 Build up the new valve set into the pump head and hand-tighten the air vent body B through the lock nut as far as it will go. Retighten the air vent body B by a further 90° with an adjustable wrench

- *There are many small parts in the liquid end. These parts must be installed correctly for proper operation of the pump (no leak or good pump output). Be sure both valve seats are in the same orientation. See the exploded view pages, also.
- *Be sure to fit gaskets are in place.
- *Keep the valve set clean.

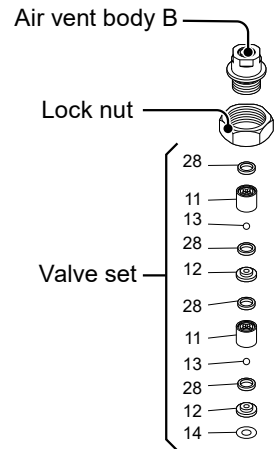

6 Remount the air vent body A using the lock nut and connect the pipe and tube

■ Suction valve set disassembly/assembly

NOTE

Be careful not to drop the valve set.

1 Remove the fitting nut and the suction tube

NOTE

Rinse chemicals or crystals off the parts as necessary.

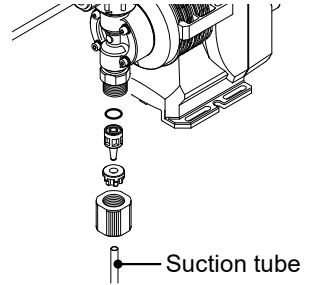

2 Remove the fitting

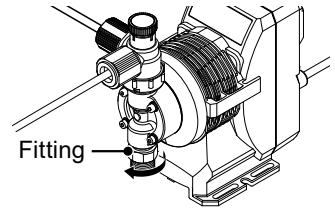

3 Pull out the valve set with a pair of tweezers

4 Build up the new valve set into the pump head and hand-tighten the air vent body B as far as it will go. Retighten it by a further 90° turn with an adjustable wrench

*There are many small parts in the liquid end. These parts must be installed correctly for proper operation of the pump (no leak or good pump output). Be sure both valve seats are in the same orientation. See the exploded view pages, also.

*Be sure to fit O rings (except pumps with SH/FC wet ends) and gaskets in place.

*Keep the valve set clean.

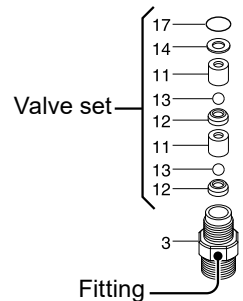

5 Reconnect the suction tube

Diaphragm replacement

Necessary tools

- An 1.06" (27mm) or wider adjustable wrench
- A 3mm or 4mm hex wrench (depending on pump size)
- A torque wrench

NOTE

A few diaphragm spacers may be inserted between the retainer and the shaft for the adjustment of the diaphragm location. Note that the number of diaphragm spacers provided varies at different pumps.

1 Run the pump to set the stroke length to 0% and stop afterward

Shorten the stroke length to 0% or just to the length that the diaphragm can be removed.

2 Loosen the fitting nuts and remove the suction tube, discharge tube, and air bleed tube

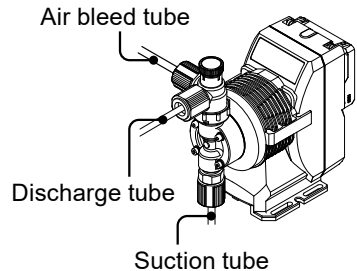

3 Remove the pump head with the 3mm or 4mm hex wrench depending on the pump size

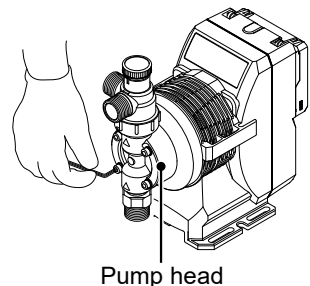

4 Unscrew the diaphragm from the shaft

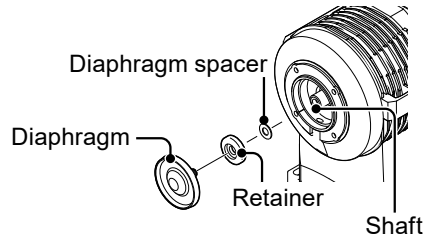

5 Slide the retainer and diaphragm spacer(s) onto the screw of the new diaphragm

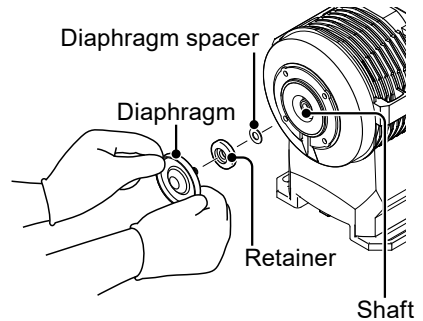

NOTE

- Fit the retainer with its round edge to the diaphragm.
- Try not to remove the separate bracket spacer during replacement. If removed inadvertently, catch the mating point with the bracket spacer and push that part into the bracket until it bottoms out.

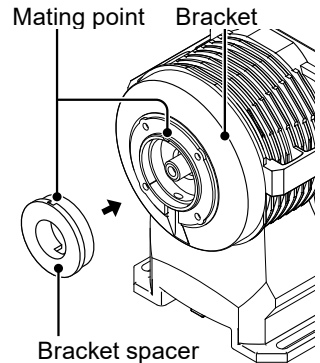

6 Screw the new diaphragm into the shaft as far as it will go

7 Run the pump and set the stroke length to 100%

Stop the pump afterward.

8 Mount the pump head

Tighten the head bolts diagonally and evenly by the specified torque at each model.

Tightening torque

Model code	Torque	Bolts
EWP-038B/-080C/-130D/-270E	19.12 lb-in (2.16 N•m)	M4 hex. sock head bolt
EWP-410F/-420F	22.57 lb-in (2.55 N•m)	M5 hex. sock head bolt

*A hex wrench can be used for a torque wrench. See page 57.

9 Reconnect the tubes

Exploded view

Pump head, Drive unit & Control unit

Do not disassemble the pump beyond the description in this manual.

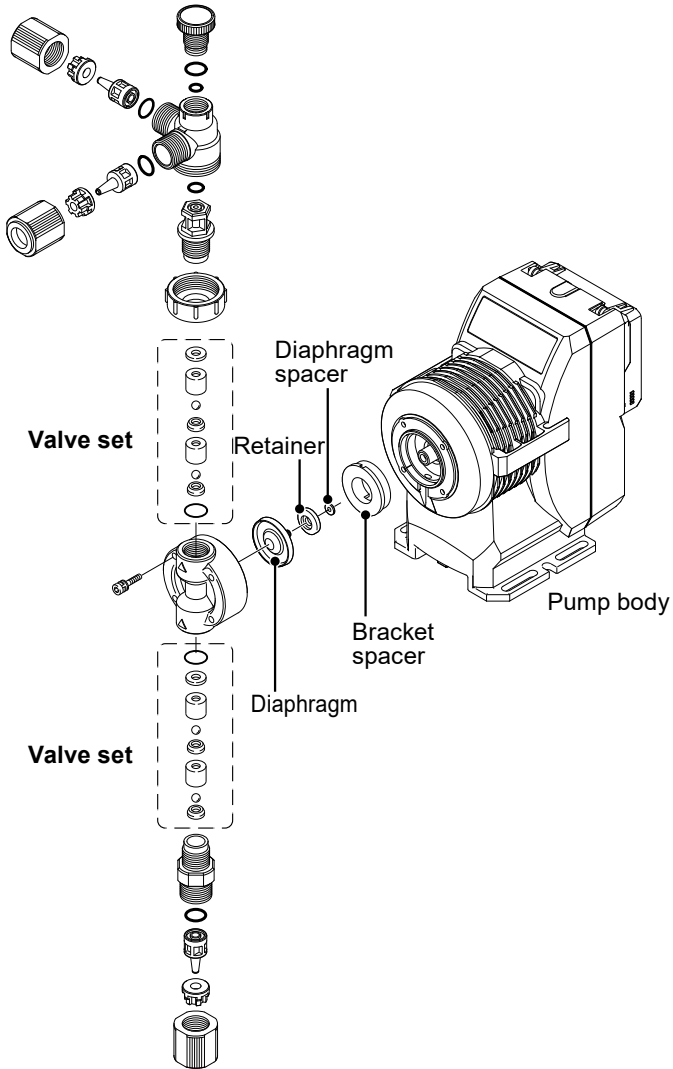

*Wet end materials and their sizes differ with models.

Pump head

■ EWP-038B/-130D/-270E/-410F/-420F VC/VS/VE/PC/PS/PE/TC

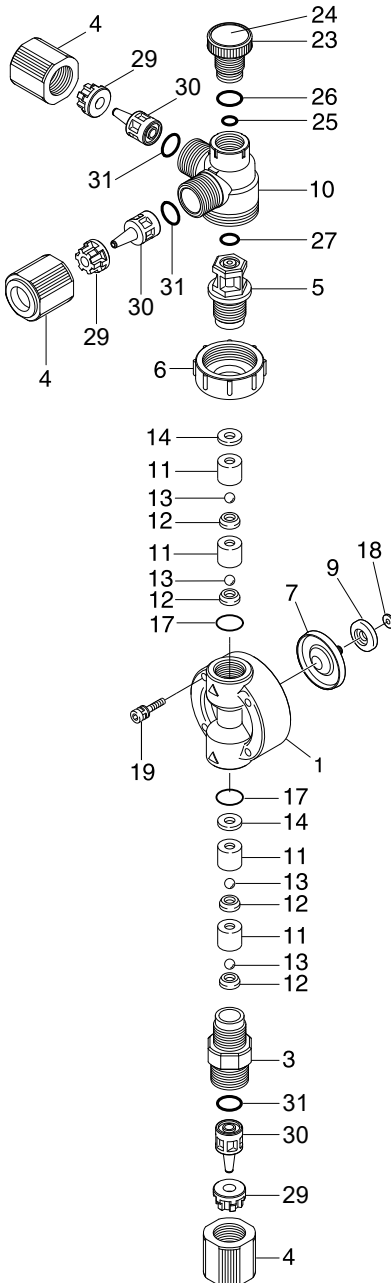

No.	Part names	# of parts
1	Pump head	1
3	Fitting	1
4	Fitting nut	3
5	Air vent body B	1
6	Lock nut	1
7	Diaphragm	1
9	Retainer	1
10	Air vent body A	1
11	Valve guide	4
12	Valve seat	4
13	Valve	4
14	Valve gasket	2
17	O ring	2
18	Diaphragm spacer	*
19	Hex. socket cap bolt [PW•SW]	4
23	Adjusting screw	1
24	Name plate	1
25	O ring	1
26	O ring	1
27	O ring	1
29	Hose stopper	3
30	Hose adaptor	3
31	O ring	3

*The number of diaphragm spacers varies with pump model.

■ EWP-038B/-080C/-130D/-270E/-410F FC

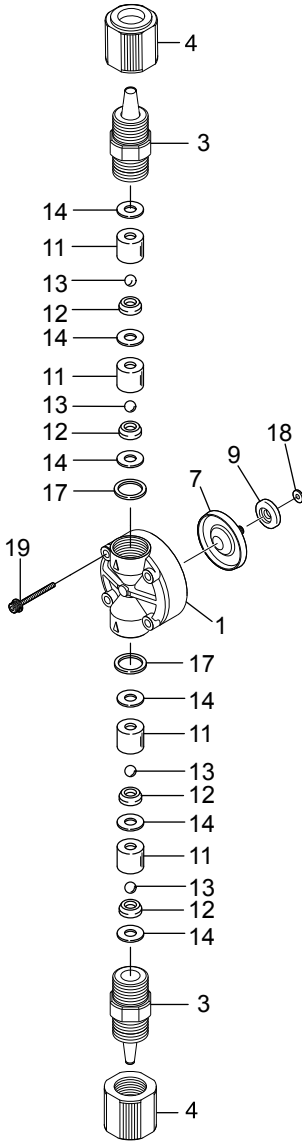

No.	Part names	# of parts
1	Pump head	1
3	Fitting	2
4	Coupling Nut	2
7	Diaphragm	1
9	Retainer	1
11	Valve guide	4
12	Valve seat	4
13	Valve	4
14	Valve gasket	6
17	Gasket	2
18	Diaphragm spacer	*
19	Hex. socket cap bolt [PW•SW]	4

*The number of diaphragm spacers varies with pump model.

■ EWP-038B/-080C/-130D/-270E/-410F SH

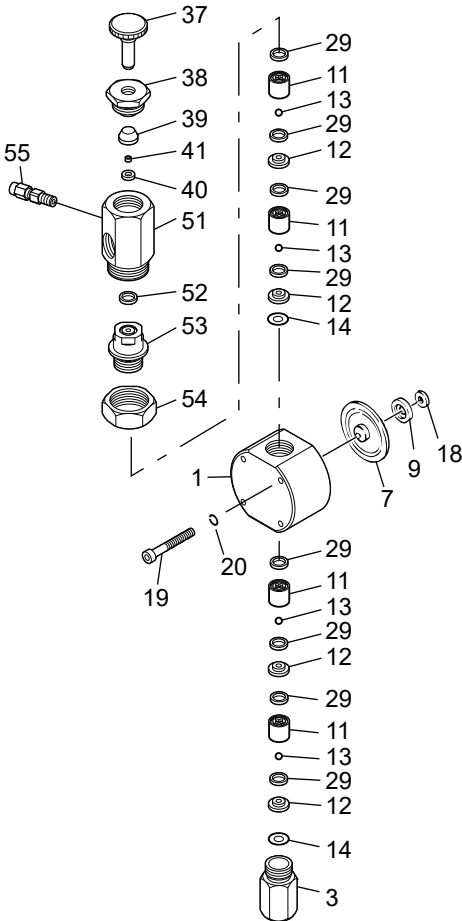

No.	Part names	# of parts
1	Pump head	1
3	Fitting	1
7	Diaphragm	1
9	Retainer	1
11	Valve guide	4
12	Valve seat	4
13	Valve	4
14	Valve gasket B	2
18	Diaphragm spacer	*
19	Hex. socket cap bolt	4
20	Spring washer	4
29	Valve gasket A	8
37	Adjusting screw	1
38	Seal nut	1
39	Seal ring	1
40	Seat	1
41	Seat ring	1
51	Air vent body A	1
52	Gasket	1
53	Air vent body B	1
54	Lock nut	1
55	Male connector	1

*The number of diaphragm spacers varies with pump model.

Specifications

Information in this section is subject to change without notice.

■ Pump unit

Model code	Max. output capacity GPH (mL/min)	Max. rated discharge pressure PSI (MPa)	Stroke length % (mm)	Stroke rate % (spm)	Average power cons. W	Average current A	Weight lbs (kg)
EWP-025A	0.602 (38)	175 (1.2)	**20-100 (0.5-1.25)	0-100 (0-360)	13	0.8	5.07 (2.3)** ³
EWP-045B	0.7 (45)	145.0 (1.0)					
EWP-075C	1.2 (75)	105 (0.7)					
EWP-125D	2.0 (125)	60 (0.4)					
EWP-265E	4.2 (265)	30 (0.2)			23	1.1	
EWP-080C	1.27 (80)	145.0 (1.0)					
EWP-130D	2.06 (130)	101.5 (0.7)					
EWP-270E	4.28 (270)	50.8 (0.35)					
EWP-420F*1	6.50 (410)	29.0 (0.2)					
EWP-420F*2	6.66 (420)						

*Maximum output capacity is rated with clean water at ambient temperature at maximum discharge pressure (also, stroke length 100%, at 360spm and rated voltage). Output may increase as pressure decreases.

*Allowable room temperature: 32-104°F (0-40°C)

*Allowable liquid temperature: 32-104°F (0-40°C) for the pumps with VC/VS/VE wet ends
(32-140°F or 0-60°C for the PC/PS/PE/TC/FC/SH wet ends)

*Allowable ambient humidity: 30-90%RH (non-condensing)

*Allowable power voltage deviation: ±10% of the rated voltage

*Maximum altitude: 6562ft (2000m)

*Pollution degree: 2

*Maximum noise level: 70dB at 1m (A scale)

*1 The EWP-420F with the TC/TA/FC/SH wet ends

*2 The EWP-420F with the VC/VF/VE/PC/PA/PE wet ends

*3 The EWP with the SH wet end is 9.7lbs (4.4kg).

*4 Stroke length is adjustable from 20-100%, but most accurate 50-100%

■ Control unit

Control modes	MAN (Manual)	0.1-100.0% (1-360spm)	
	ANA.P	4-20/20-4/0-20/20-0mA (preset proportional patterns)	
	ANA.V	User-entry set points (output in proportion to 0-20mA)	
	PLS.V	User-entry set points (output in proportion to 0-100/500Hz, 50:50 duty ratio)	
	DIV	n (1-9999) signals per stroke (n = divisor)	
	MULTI	n (1-9999) strokes per signal (n = multiplier)	
	BATCH	The pump runs to meet a batch volume per signal.	
	INT. B	The pump runs to meet a batch volume at a set time interval.	
Displays	LCD	14×5 backlit LCD	Control modes, pump status or so
		7×4 backlit LCD	Output capacity, set value or so
		Others	Flow units, status indicators
	Status LED	Lights white when the pump is in the wait state or menu mode.	
		Blinks green synchronously with strokes when the pump is running.	
		Blinks orange synchronously with strokes when the Pre-STOP signal is input.	
Turns purple when the STOP signal is input.			
		Turns red when the pump is interlocked.	
Control functions	STOP/Pre-STOP	Pump keeps running while the Pre-STOP signal is input and stops at the STOP signal input.*1	
	PRIME	Max spm operation while holding down the START/STOP key.	
	Keypad lock	PIN number entry disables the function.	
	Interlock	Pump stops at contact input.	
	AUX	Pump runs at the preset AUX speed.	
	Max capacity setting	The max output capacity of the MAN, EXT, PRIME modes.	
	Buffer memory	MULTI/DIV: Excess pulse signal can be stored up to 65535 shots. ON/OFF is selectable. BATCH: Accumulates the flow volume up to 99.9999L (26.4199gal). ON/OFF is selectable.	
	Current value indication	An input current is displayed during operation in the ANA.V /ANA.P mode.	
Input	STOP/Pre-STOP	Dry contact or Open collector*3	
	AUX	Dry contact or Open collector*3	
	Interlock	Dry contact or Open collector*3	
	Analog	0-20mADC (input resistance 220Ω)	
	Pulse	Dry contact or Open collector*3, UP to 100Hz (factory default, the frequency changes with the bounce threshold.)	

Output	OUT1	Open collector, 30mA 24VDC MAX
	Auxiliary DC power	12VDC, 30mA
Power voltage	100-240VAC*2	

*1 The factory default setting (the STOP/Pre-STOP signal is activated at contact input) can be changed to “the signal is deactivated at contact input”.

*2 Observe the allowable power voltage range of 90-264VAC. Or failure may result.

*3 The maximum applied voltage to the contact is 5VDC at 2.3mA. The minimum application load of the relay or switch should be 1mA or below.

■ Power cable

Wire size (Cross section area)	18 AWG (0.824 mm ²) 3-conductor	
Length	75.74" (inch)	
Cable type/standard	SJTW	
Plug end	US	NEMA 5-15P (115V)
	UH	NEMA 6-15P (230V)

■ Pump color

Blue	Munsell color system 7.5PB 3/8
------	--------------------------------

Outer dimensions

■ EWP-038B/-080C/-130D/-270E/-410F/-420F VC/VS/VE/PC/PS/PE/TC

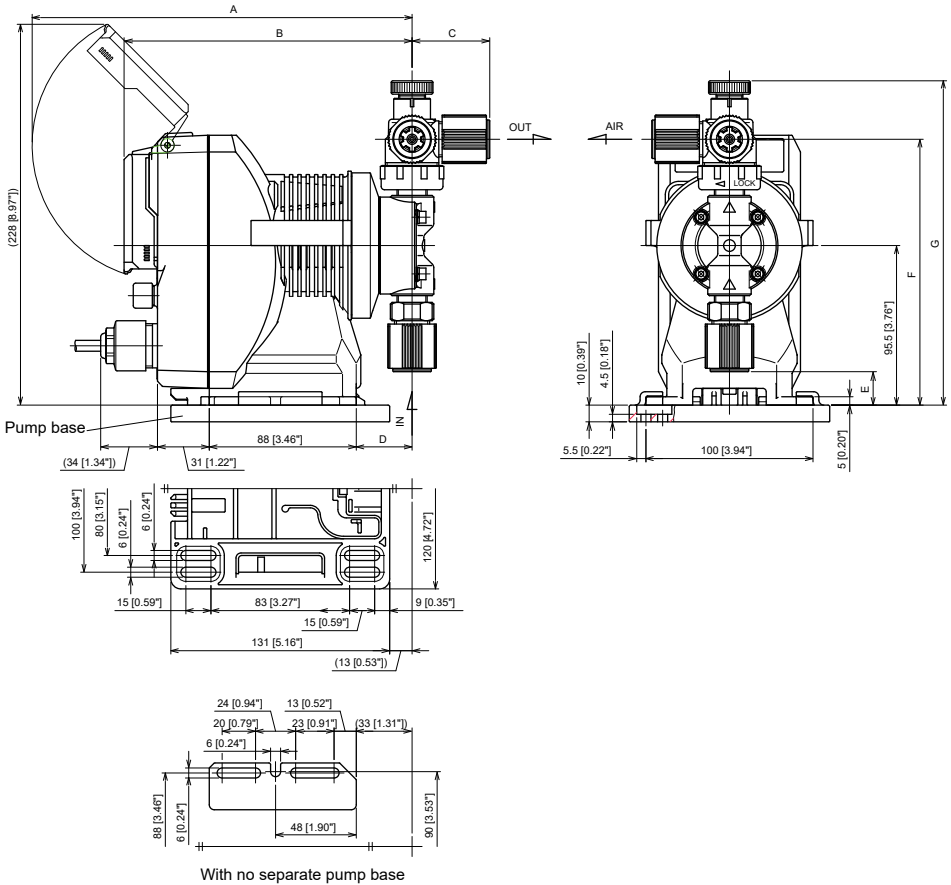

Dimensions in inches (mm)

Pump unit	A	B	C	D	E	F	G
038B	8.94" (227)	6.77" (172)	1.85" (47)	1.30" (33)	0.79" (20)	6.26" (159)	7.64" (194)
080C						6.77" (172)	8.15" (207)
130D							
270E	9.02" (229)	6.85" (174)	1.38" (35)	0.24" (6)	6.77" (172)	8.15" (207)	
410F/420F					6.73" (171)	8.11" (206)	

*The pump with the 09/10 tube-size code has the different dimension C and E. Contact us for more information.

■ EWP-038B/-080C/-130D/-270E/-410F FC

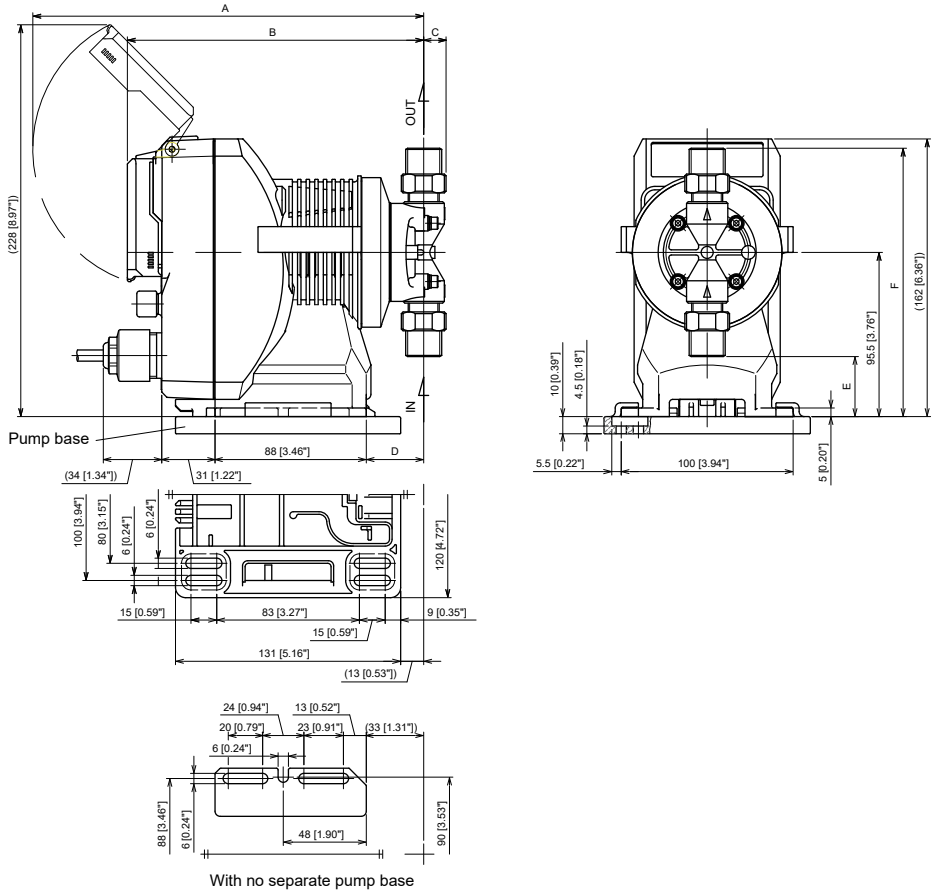

Dimensions in inches (mm)

Pump unit	A	B	C	D	E	F
038B	8.94"	6.77"	0.51"	1.30"	1.38"	6.14"
080C	(227)	(172)	(13)	(33)	(35)	(156)
130D						
270E	9.02"	6.85"	0.63"	1.38"	0.75"	6.81"
410F	(229)	(174)	(16)	(35)	(19)	(173)

■ EWP-038B/-080C/-130D/-270E/-410F SH

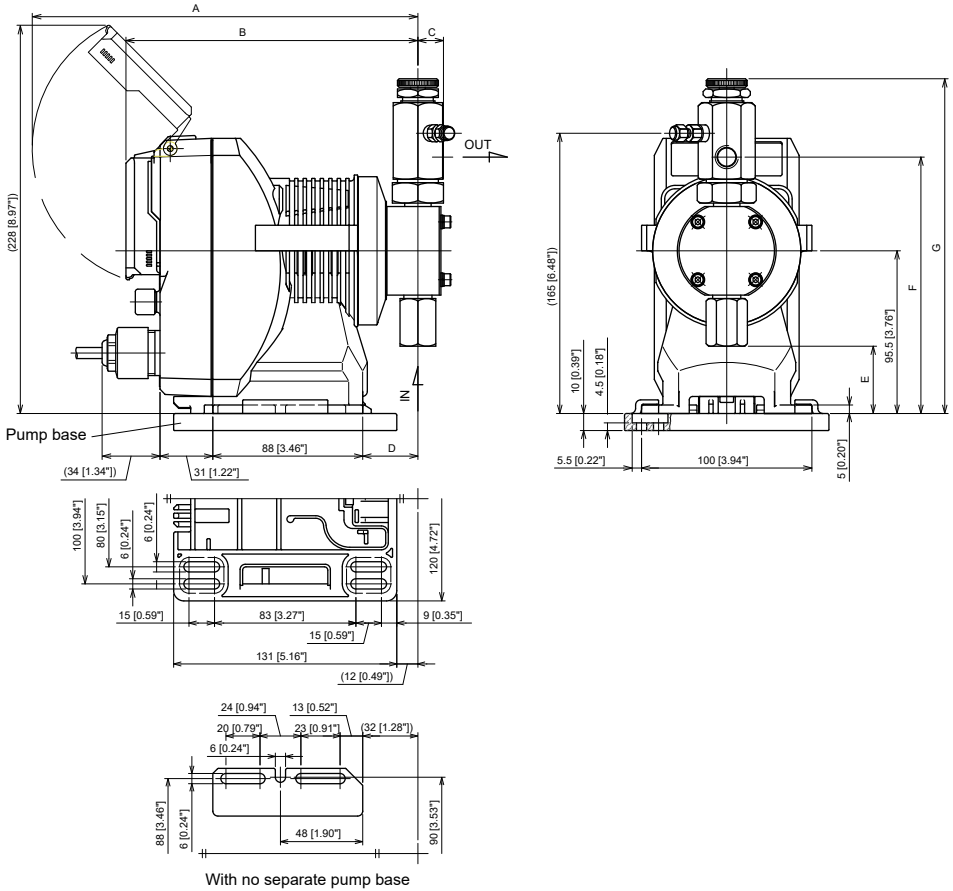

Dimensions in inches (mm)

Pump unit	A	B	C	D	E	F	G
038B	8.90" (226)	6.73" (171)	0.59" (15)	1.26" (32)	1.57" (40)	5.94" (151)	7.76" (197)
080C							
130D							
270E	8.98" (228)	6.81" (173)		1.34" (34)	1.18" (30)	6.42" (163)	8.23" (209)
410F					1.06" (27)	6.50" (165)	8.31" (211)

Anchorage points guide (Wall-mount use of the pump base)

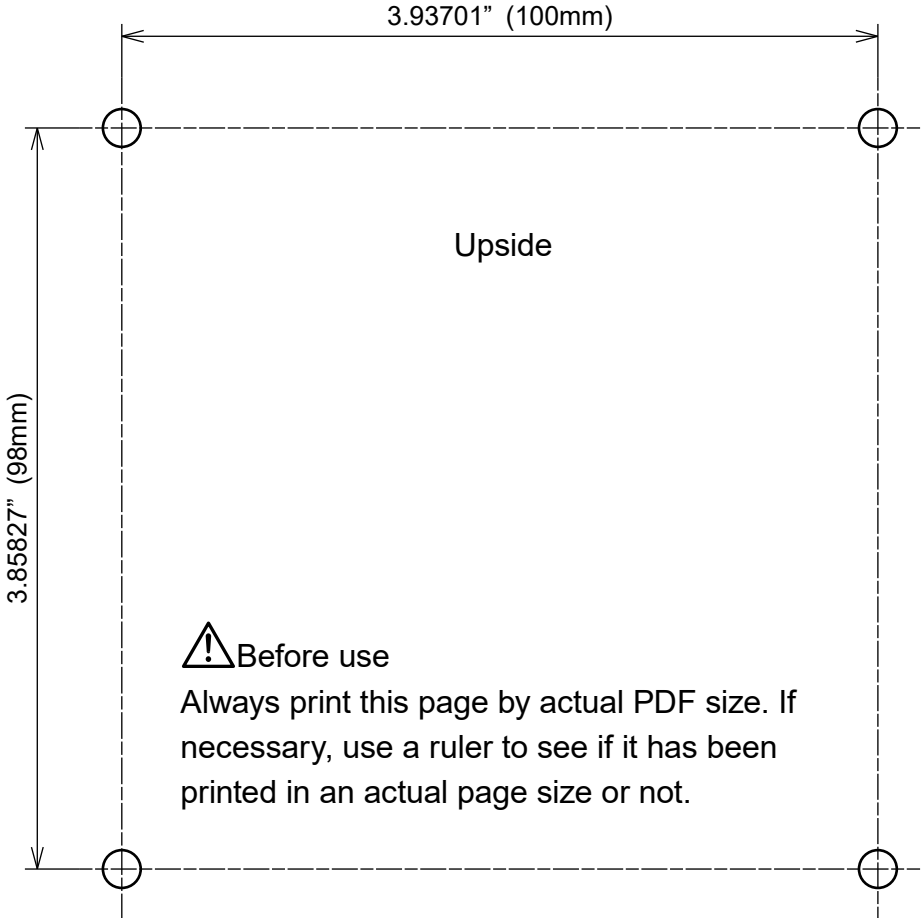

*Use this page and drill the wall for wall mounting with the base of the pump. Copy or cut as necessary. Use a proper drill size for the wall to have M5 anchor nut. Always select the rigid wall for wall-mounting of the pump. Do not drop. It's not the manufacturer's responsibility for any failure or damage resulting from a dropped pump.

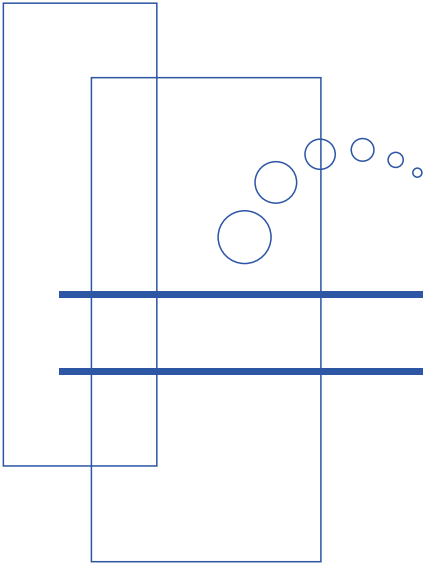

<https://www.iwakipumps.jp>

IWAKI CO.,LTD. 6-6 Kanda-Sudacho 2-chome Chiyoda-ku Tokyo 101-8558 Japan
TEL: +81 3 3254 2935 FAX: +81 3 3252 8892

European Headquarter / IWAKI Europe GmbH
TEL: +49 2154 9254 0 FAX: +49 2154 9254 48

Germany / IWAKI Europe GmbH
TEL: +49 2154 9254 50 FAX: +49 2154 9254 55

The Netherlands / IWAKI Europe GmbH (Netherlands Branch)
TEL: +31 74 2420011 FAX: +49 2154 9254 48

Italy / IWAKI Europe GmbH (Italy Branch)
TEL: +39 0445 561219 FAX: +39 0445 569088

Spain / IWAKI Europe GmbH (Spain Branch)
TEL/FAX: +34 934 741 638

Poland / IWAKI Europe GmbH (East Europe Branch)
TEL: +48 12 347 0755 FAX: +48 12 347 0900

Denmark / IWAKI Nordic A/S
TEL: +45 48 242345

Finland / IWAKI Suomi Oy
TEL: +358 10 201 0490

Norway / IWAKI Norge AS
TEL: +47 23 38 49 00

Sweden / IWAKI Sverige AB
TEL: +46 8 511 72900

Belgium / IWAKI Belgium N.V.
TEL: +32 13 670200 FAX: +32 13 672030

France / IWAKI France S.A.
TEL: +33 1 69 63 33 70 FAX: +33 1 64 49 92 73

U.S.A. / IWAKI America Inc.
TEL: +1 508 429 1440 FAX: +1 508 429 1386

Brazil / IWAKI Do Brasil Comercio De Bombas Hidraulicas LTDA.
TEL/FAX: +55 19 3244 5900

China (Shanghai) / IWAKI Pumps (Shanghai) Co., Ltd.
TEL: +86 21 6272 7502 FAX: +86 21 6272 6929

China (Hong Kong) / IWAKI Pumps Co., Ltd.
TEL: +852 2607 1168 FAX: +852 2607 1000

China (Guangzhou) / GFTZ IWAKI Engineering & Trading Co., Ltd.
TEL: +86 20 84350603 FAX: +86 20 84359181

China (Shenzhen) / IWAKI Pumps (Shenzhen) Co., Ltd.
TEL: +86 0755 8656 3696

Singapore / IWAKI Singapore Pte Ltd.
TEL: +65 6316 2028 FAX: +65 6316 3221

Indonesia / IWAKI Singapore Pte Ltd. (Indonesia Office)
TEL: +62 21 6906606 FAX: +62 21 6906612

Malaysia / IWAKim SDN. BHD.
TEL: +60 3 7803 8807 FAX: +60 3 7803 4800

Korea / IWAKI Korea Co., Ltd.
TEL: +82 2 6238 4800 FAX: +82 2 6238 4801

Taiwan / IWAKI Pumps Taiwan Co., Ltd.
TEL: +886 2 8227 6900 FAX: +886 2 8227 6818

Thailand / IWAKI (Thailand) Co., Ltd.
TEL: +66 2 322 2471 FAX: +66 2 322 2477

Australia / IWAKI Pumps Australia Pty Ltd.
TEL: +61 2 9899 2411 FAX: +61 2 9899 2421